

HoseGuard®

The HoseGuard® offers simple but effective protections to pneumatic systems in the event of a broken compressed air hose or pipe. The air supply is immediately shut off by the HoseGuard®, should the volume of air exceed a set value. This value is factory preset and is set to allow normal air consumption when using air tools. Should the air consumption exceed a set value, e.g. the air is severed, then the internal piston instantly shuts off the main flow. An integral bleed hole allows some air to flow through. This enables the line pressure to automatically reset the HoseGuard® once the main break is repaired.



Thread Connection	Description	Dimensions (mm)				Weight Gram	Maximum Inlet Pressure	Temperature Range	Material	Inlet Thread	Outlet Thread	Order Code	
		A	B	C	AF							BSP	NPT
HoseGuard® Air Fuse Standard Aluminium													
BSP/NPT													
1/4"	Standard	49	-	-	22	33	18 bar 255 psig	-20 °C to 80°C (-4°F to 176°F)	Housing: Aluminium Other Parts: Nitrile Rubber, plastic, stainless steel	Female	Female	281A0211	281A1211
1/4"	Standard	59	49	-	22	40				Male	Female	281A0221	281A1221
1/4"	Low Flow	49	-	-	22	33				Female	Female	281ZL0211	281ZL1211
1/4"	Low Flow	59	49	-	22	40				Male	Female	281ZL0221	281ZL1221
1/4"	High Flow	49	-	-	22	33				Female	Female	281ZH0211	281ZH1211
1/4"	High Flow	59	49	-	22	40				Male	Female	281ZH0221	281ZH1221
3/8"	Standard	58	-	-	27	60				Female	Female	281A0311	281A1311
3/8"	Standard	70	58	-	27	67				Male	Female	281A0321	281A1321
3/8"	High Flow	58	-	-	27	60				Female	Female	281ZH0311	281ZH1311
3/8"	High Flow	70	58	-	27	67				Male	Female	281ZH0321	281ZH1321
1/2"	Standard	65	-	-	30	78				Female	Female	281A0411	281A1411
1/2"	Standard	79	64	-	30	85				Male	Female	281A0421	281A1421
1/2"	Low Flow	65	-	-	30	78				Female	Female	281ZL0411	281ZL1411
1/2"	Low Flow	79	64	-	30	85				Male	Female	281ZL0421	281ZL1421
1/2"	High Flow	65	-	-	30	78	Female	Female	281ZH0411	281ZH1411			
1/2"	High Flow	79	64	-	30	85	Male	Female	281ZH0421	281ZH1421			
3/4"	Standard	76	-	36	30	107	-20 °C to 120°C (-4°F to 248°F)	Housing: Aluminium Other Parts: Nitrile Rubber, plastic, stainless steel	Female	Female	281A0511	281A1511	
3/4"	High Flow	76	-	36	30	107			Female	Female	281ZH0511	281ZH1511	
1"	Standard	100	-	50	41	320			Female	Female	281A0611	281A1611	
1"	High Flow	100	-	50	41	320			Female	Female	281ZH0611	281ZH1611	

Technical Data:

Pressure drop: Open: 0,05 - 0,1 bar / 0,7 - 1,5 psig
By closing: 0,3 bar / 5 psig

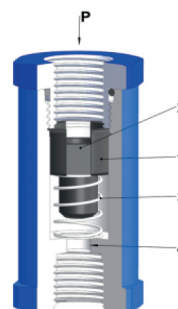
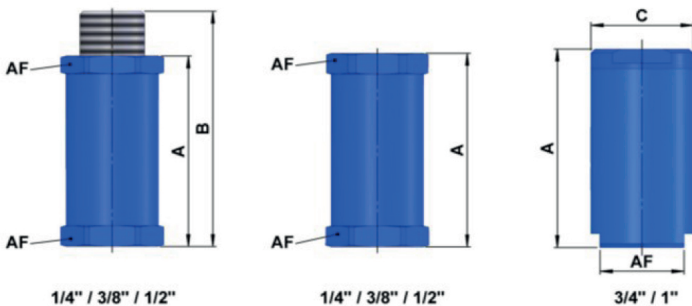

How the HoseGuard works:

P is the inlet.
The air passes the piston 1 and continues through the seat.
The air flow, passing the piston, is slowed down by means of some lengthwise grooves 3 on the outer side of the piston.

If the flow is too high, the air cannot pass the piston quickly enough, and the piston will be pressed against the spring 2 towards the seat.
If the value indicated is exceeded, e.g. if the hose suddenly breaks, the air supply is automatically shut off.

HoseGuard® - Stainless Steel



Thread Connection	Description	Dimensions (mm)				Weight Gram	Maximum Inlet Pressure	Temperature Range	Material	Inlet Thread	Outlet Thread	Order Code	
		A	B	C	AF							BSP	NPT
BSP/NPT	HoseGuard® Air Fuse Stainless Steel - 316L											Other dimensions on request	
1/4"	Standard	50	-	19.5	17	67	18 bar 255 psig	-20 °C to 80°C (-4°F to 176°F)	Housing: Stainless Steel DIN 17440 Material No. 1.4404 Piston: POM-Polyoxymethylene, Keptal F20-03, Spring: Stainless Steel DIN 17224 Material No. 1.4310, O-Ring: Nitrile Rubber (NBR) / viton (FKM) Optional: Piston: Stainless Steel	Female	Female	281R0211	281R1211
1/4"	Standard	50	60	19.5	17	Male				Female	281R0221	281R1221	
1/4"	Low Flow	50	-	19.5	17	67				Female	Female	281RL0211	281RL1211
1/4"	Low Flow	50	60	19.5	17	Male				Female	281RL0221	281RL1221	
1/4"	High Flow	50	-	19.5	17	67				Female	Female	281RH0211	281RH1211
1/4"	High Flow	50	60	19.5	17	Male				Female	281RH0221	281RH1221	
1/2"	Standard	67	-	30	26	192				Female	Female	281R0411	281R1411
1/2"	Standard	67	81.5	30	26	Male				Female	281R0421	281R1421	
1/2"	Low Flow	67	-	30	26	192				Female	Female	281RL0411	281RL1411
1/2"	Low Flow	67	81.5	30	26	Male				Female	281RL0421	281RL1421	
1/2"	High Flow	67	-	30	26	192				Female	Female	281RH0411	281RH1411
1/2"	High Flow	67	81.5	30	26	Male				Female	281RH0421	281RH1421	

Technical Data:

Pressure drop: Open: 0,05 - 0,1 bar / 0,7 - 1,5 psig
By closing: 0,3 bar / 5 psig

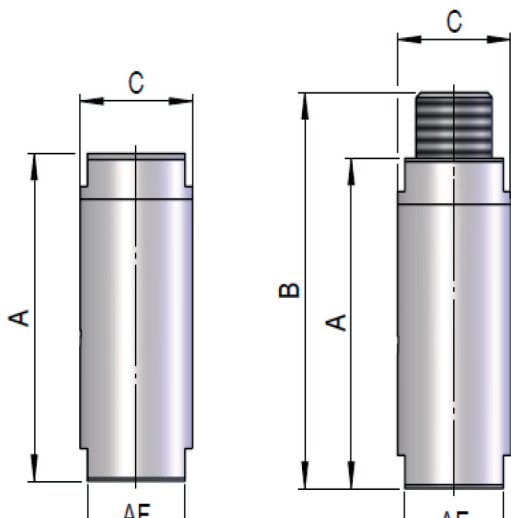

Important Information:

All the following measurement values (flow for closing function) apply for a HoseGuard® (hose breakage safety device) charged with the appropriate pressure P1 and with a free Pa outlet.
If a component is fitted after the HoseGuard® which reduces the flow performance (e.g. linkage, screw fitting, hose etc.), it is possible that the required flow for the de-fined closing point is no longer attained and that the HoseGuard® will not close.
In this case the application must be appropriately tested. It is possible that another component may have to be selected after the HoseGuard®, or a smaller HoseGuard®, depending on the test result.

All the following measurement values (flow for closing function) apply for a HoseGuard® (hose breakage safety device) charged with the appropriate pressure P1 and with a free Pa outlet. If a component is fitted after the HoseGuard® which reduces the flow performance (e.g. linkage, screw fitting, hose etc.), it is possible that the required flow for the defined closing point is no longer attained and that the HoseGuard® will not close. In this case the application must be appropriately tested. It is possible that another component may have to be selected after the HoseGuard®, or a smaller HoseGuard®, depending on the test result.

HoseGuard® 1/4"

Flow measurement according to DIN EN 60534

Air flow rate for closing (+ - 10%)

p1	p1	Dp	Dp	T	RF	RF	V	V
(barü)	(psig)	(bar)	(psig)	(K)	(NI/min)	(scfm)	(NI/min)	(scfm)
18	260	0.40	5.8	284	180	6.5	1100	39
15	220	0.40	5.8	283	160	5.5	1010	36
10	145	0.40	5.8	283	110	4.0	830	29
8	120	0.40	5.8	283	95	3.5	760	27
6	90	0.40	5.8	283	75	2.6	670	24
5	75	0.40	5.8	283	65	2.3	610	22
4	60	0.40	5.8	283	55	2.0	560	20

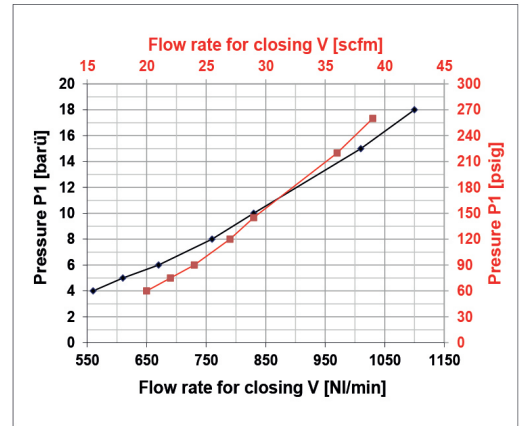

p1: Inlet pressure | Dp: Pressure difference | T: Temperature | RF: Reset Flow | V: Flow rate for closing

HoseGuard® 1/4" Low Flow

Flow measurement according to DIN EN 60534

Air flow rate for closing (+ - 10%)

p1	p1	Dp	Dp	T	RF	RF	V	V
(barü)	(psig)	(bar)	(psig)	(K)	(NI/min)	(scfm)	(NI/min)	(scfm)
18	260	0.07	1.0	283	37	1.30	74	2.6
15	220	0.07	1.0	282	29	1.00	68	2.4
10	145	0.07	1.0	284	21	0.75	58	2.0
8	120	0.06	0.8	283	18	0.65	52	1.8
6	90	0.07	1.0	286	15	0.52	47	1.6
5	75	0.06	0.8	286	14	0.49	41	1.4
4	60	0.06	0.8	286	12	0.42	37	1.3

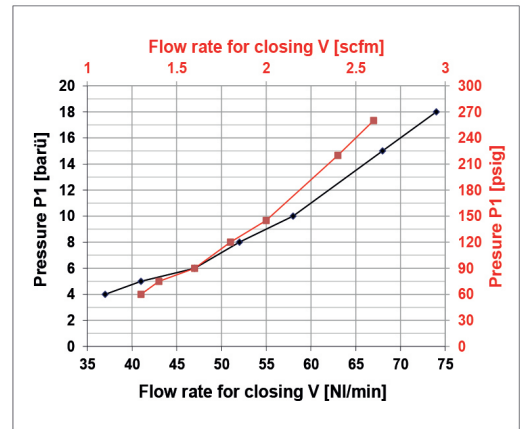

p1: Inlet pressure | Dp: Pressure difference | T: Temperature | RF: Reset Flow | V: Flow rate for closing

HoseGuard® 1/4" High Flow

Flow measurement according to DIN EN 60534

Air flow rate for closing (+ - 10%)

p1	p1	Dp	Dp	T	RF	RF	V	V
(barü)	(psig)	(bar)	(psig)	(K)	(NI/min)	(scfm)	(NI/min)	(scfm)
18	260	0.90	13.0	287	180	6.5	1460	52
15	220	0.90	13.0	286	160	5.5	1340	47
10	145	0.90	13.0	287	110	4.0	1090	38
8	120	0.90	13.0	284	95	3.5	990	35
6	90	0.90	13.0	282	75	2.6	900	32
5	75	1.00	14.5	282	65	2.3	850	30
4	60	1.00	14.5	282	55	2.0	780	28

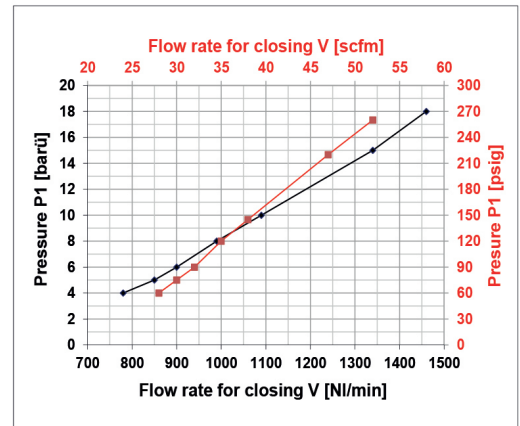

p1: Inlet pressure | Dp: Pressure difference | T: Temperature | RF: Reset Flow | V: Flow rate for closing

HoseGuard® 3/8"

Flow measurement according to DIN EN 60534

Air flow rate for closing (+ - 10%)

p1	p1	Dp	Dp	T	RF	RF	V	V
(barü)	(psig)	(bar)	(psig)	(K)	(NI/min)	(scfm)	(NI/min)	(scfm)
18	260	0.20	2.9	282	180	6.5	1620	57
15	220	0.20	2.9	283	160	5.5	1430	50
10	145	0.21	3.0	283	110	4.0	1180	42
8	120	0.20	2.9	284	95	3.5	1080	38
6	90	0.19	2.7	285	75	2.6	930	33
5	75	0.20	2.9	284	65	2.3	870	31
4	60	0.19	2.7	284	55	2.0	790	28

p1: Inlet pressure | Dp: Pressure difference | T: Temperature | RF: Reset Flow | V: Flow rate for closing

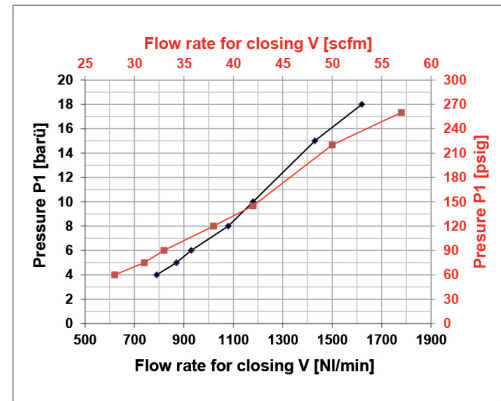

HoseGuard® 3/8" High Flow

Flow measurement according to DIN EN 60534

Air flow rate for closing (+ - 10%)

p1	p1	Dp	Dp	T	RF	RF	V	V
[barü]	(psig)	[bar]	(psig)	[K]	(NI/min)	(scfm)	[NI/min]	(scfm)
18	260	0.23	3.3	282	180	6.5	2150	76
15	220	0.23	3.3	282	160	5.5	1960	69
10	145	0.23	3.3	283	110	4.0	1620	57
8	120	0.22	3.2	284	95	3.5	1450	51
6	90	0.22	3.2	286	75	2.6	1290	45
5	75	0.23	3.3	285	65	2.3	1200	42
4	60	0.23	3.3	283	55	2.0	1090	38

p1: Inlet pressure | Dp: Pressure difference | T: Temperature | RF: Reset Flow | V: Flow rate for closing

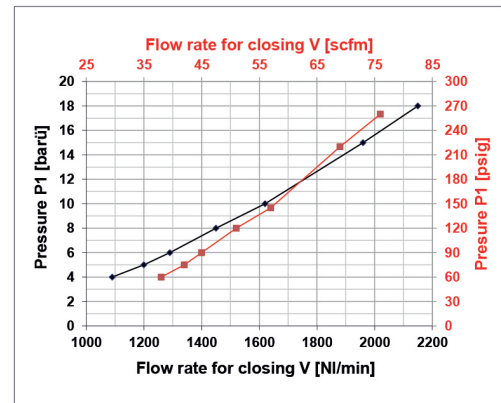

HoseGuard® 1/2"

Flow measurement according to DIN EN 60534

Air flow rate for closing (+ - 10%)

p1	p1	Dp	Dp	T	RF	RF	V	V
(barü)	(psig)	(bar)	(psig)	(K)	(NI/min)	(scfm)	(NI/min)	(scfm)
18	260	0.36	5.2	282	180	6.5	4520	160
15	220	0.37	5.4	282	160	5.5	4120	145
10	145	0.37	5.4	283	110	4.0	3380	119
8	120	0.36	5.2	284	95	3.5	3020	107
6	90	0.35	5.0	283	75	2.6	2710	96
5	75	0.35	5.0	282	65	2.3	2530	89
4	60	0.35	5.0	281	55	2.0	2240	79

p1: Inlet pressure | Dp: Pressure difference | T: Temperature | RF: Reset Flow | V: Flow rate for closing

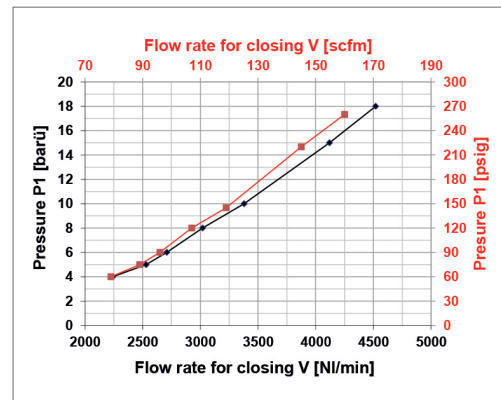

HoseGuard® 1/2" Low Flow

Flow measurement according to DIN EN 60534

Air flow rate for closing (+ - 10%)

p1	p1	Dp	Dp	T	RF	RF	V	V
(barü)	(psig)	(bar)	(psig)	(K)	(NI/min)	(scfm)	(NI/min)	(scfm)
18	260	0.24	3.5	276	180	6.5	3470	123
15	220	0.24	3.5	275	160	5.5	3200	113
10	145	0.25	3.6	275	110	4.0	2600	92
8	120	0.26	3.8	275	95	3.5	2360	83
6	90	0.26	3.8	276	75	2.6	2060	73
5	75	0.26	3.8	281	65	2.3	1920	68
4	60	0.26	3.8	280	55	2.0	1750	62

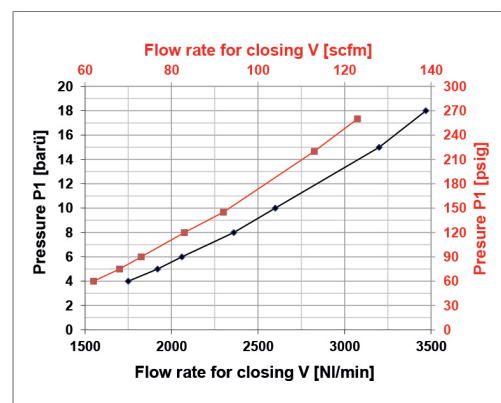

HoseGuard® 1/2" High Flow

Flow measurement according to DIN EN 60534
Air flow rate for closing (+ - 10%)

p1	p1	Dp	Dp	T	RF	RF	V	V
(barü)	(psig)	(bar)	(psig)	(K)	(NI/min)	(scfm)	(NI/min)	(scfm)
18	260	0.41	5.9	282	180	6.5	5220	184
15	220	0.42	6.1	282	160	5.5	4710	166
10	145	0.42	6.1	283	110	4.0	3850	136
8	120	0.41	5.9	285	95	3.5	3440	121
6	90	0.40	5.8	284	75	2.6	3040	107
5	75	0.41	5.9	283	65	2.3	2820	100
4	60	0.41	5.9	282	55	2.0	2570	91

p1: Inlet pressure | Dp: Pressure difference | T: Temperature | RF: Reset Flow | V: Flow rate for closing

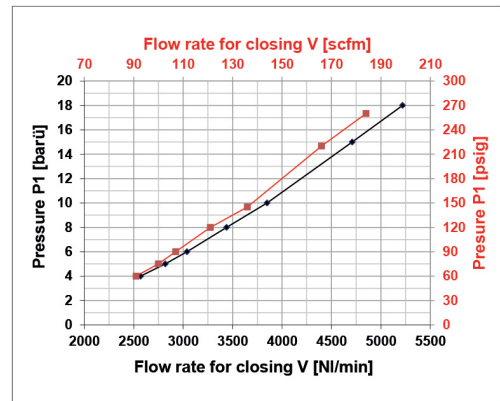

HoseGuard® 3/4"

Flow measurement according to DIN EN 60534
Air flow rate for closing (+ - 10%)

p1	p1	Dp	Dp	T	RF	RF	V	V
(barü)	(psig)	(bar)	(psig)	(K)	(NI/min)	(scfm)	(NI/min)	(scfm)
18	260	0.24	3.5	282	690	24.5	6130	217
15	220	0.24	3.5	281	580	20.5	5520	195
10	145	0.25	3.6	283	400	14.0	4470	158
8	120	0.24	3.5	281	330	11.5	4070	144
6	90	0.25	3.5	283	260	9.0	3600	127
5	75	0.25	3.5	287	220	8.0	3280	116
4	60	0.25	3.5	285	180	6.5	2960	104

p1: Inlet pressure | Dp: Pressure difference | T: Temperature | RF: Reset Flow | V: Flow rate for closing

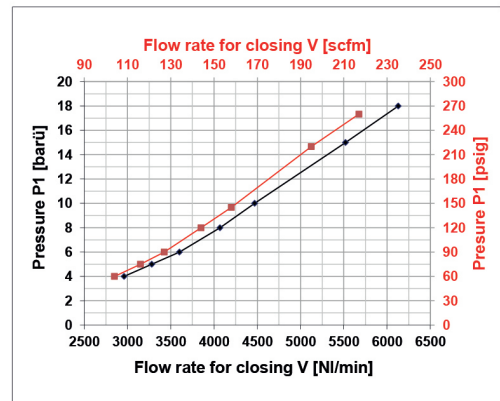

HoseGuard® 3/4" High Flow

Flow measurement according to DIN EN 60534
Air flow rate for closing (+ - 10%)

p1	p1	Dp	Dp	T	RF	RF	V	V
(barü)	(psig)	(bar)	(psig)	(K)	(NI/min)	(scfm)	(NI/min)	(scfm)
18	260	0.29	4.2	282	2380	84	7930	280
15	220	0.29	4.2	282	2000	71	7120	252
10	145	0.30	4.3	282	1380	49	5810	205
8	120	0.29	4.2	281	1120	40	5250	185
6	90	0.31	4.5	283	880	31	4570	161
5	75	0.31	4.5	290	750	26.5	4230	149
4	60	0.31	4.5	285	630	22.5	3810	134

p1: Inlet pressure | Dp: Pressure difference | T: Temperature | RF: Reset Flow | V: Flow rate for closing

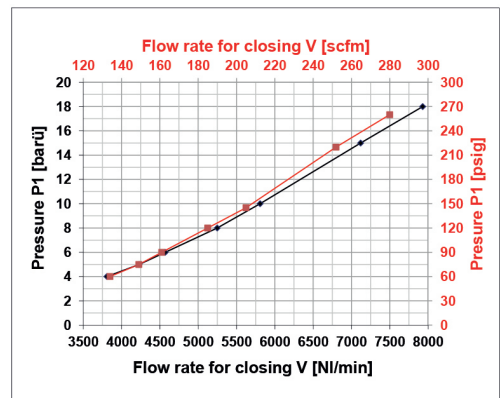

HoseGuard® 1"

Flow measurement according to DIN EN 60534
Air flow rate for closing (+ - 10%)

p1	p1	Dp	Dp	T	RF	RF	V	V
(barü)	(psig)	(bar)	(psig)	(K)	(NI/min)	(scfm)	(NI/min)	(scfm)
18	260	0.21	3.0	282	1440	51	8080	285
15	220	0.20	2.9	283	1200	43	7300	258
10	145	0.21	3.0	283	840	29.5	5860	207
8	120	0.22	3.2	284	690	24.5	5220	184
6	90	0.21	3.0	283	530	18.5	4610	163
5	75	0.20	2.9	288	460	16.5	4230	149
4	60	0.20	2.9	287	380	13.5	3900	138

p1: Inlet pressure | Dp: Pressure difference | T: Temperature | RF: Reset Flow | V: Flow rate for closing

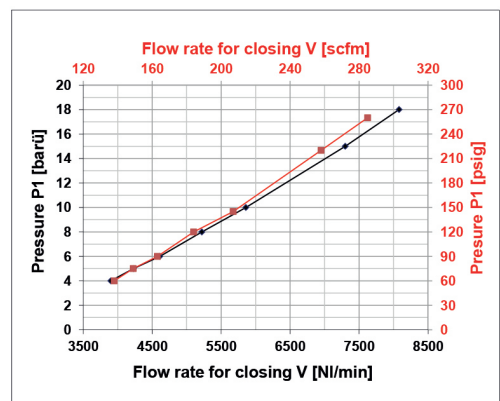

HoseGuard® 1" High Flow

Flow measurement according to DIN EN 60534

Air flow rate for closing (+ - 10%)

p1	p1	Dp	Dp	T	RF	RF	V	V
(barü)	(psig)	(bar)	(psig)	(K)	(NI/min)	(scfm)	(NI/min)	(scfm)
18	260	0.27	3.9	282	1440	51	11820	417
15	225	0.27	3.9	281	1200	43	10350	366
10	150	0.27	3.9	283	840	29.5	8300	293
8	120	0.27	3.9	284	690	24.5	7600	268
6	90	0.27	3.9	284	530	18.5	6680	236
5	75	0.27	3.9	286	460	16.5	6350	224
4	60	0.26	3.8	285	380	13.5	5850	207

p1: Inlet pressure | Dp: Pressure difference | T: Temperature | RF: Reset Flow | V: Flow rate for closing

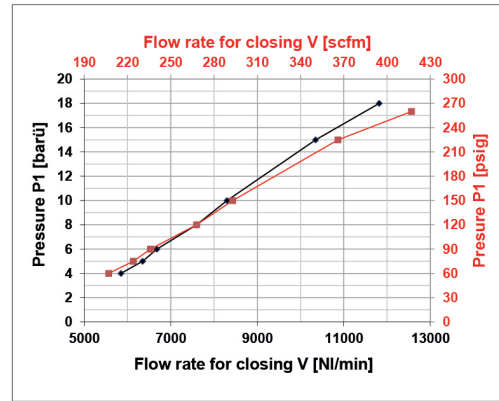

HoseGuard® Function-Test set up

Exchange the pneumatic tool or device with a ball valve. The ball valve has to be closed and firmly affixed (ideally in a vice). Switch the compressed air back on again. Once the operating pressure has been reached, open the Valve quickly to simulate a broken hose.

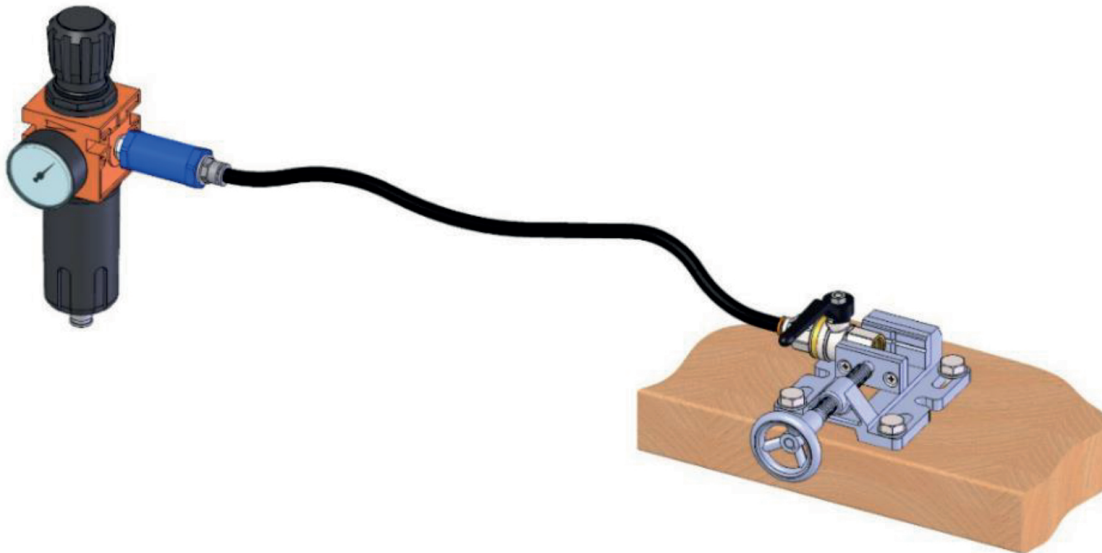

Troubleshooting

(Please also refer to the [Instruction for use](#))

HoseGuard® does not close (= full flow):

- Step 1: Make sure the HoseGuard® has been installed correctly with the correct direction.
- Step 2: Verify that there is no other product between the Hoseguard® and the tool/device, and that one HoseGuard® is installed for not more than one supply-line.
- Step 3: Make sure there is enough flow (see EasyHoseGuard®finder [psi](#) or [bar](#)), if the flow is too low, then the HoseGuard® is too small.
- Step 4: Check if the inner tube diameter and the corresponding fittings and couplers have the corresponding diameter 1/4"= 6mm, 3/8"= 10mm, 1/2"= 13mm, 3/4"= 16mm, 1"=19mm. The longer the hose the wider has the diameter to be.

HoseGuard® closes constantly (= few flow):

- Step 1: Visually inspect the HoseGuard® and make sure piston moves relatively smoothly.
- Step 2: Make sure there is no other product between the Hoseguard® and the tool/device, and that one HoseGuard® is installed for not more than one supply-line.
- Step 3: Verify the flow¹ of the function/consumer. The HoseGuard will close if the flow of the pneumatic tool /device is too high. Please refer to the EasyHoseGuard®finder [psi](#) or [bar](#).

¹ Durchflüsse sollten am besten vor Ort am Verbraucher und ev. vor dem HoseGuard® gemessen werden, wenn nicht möglich kann der Hersteller des Werkzeugs/Verbrauchers Angaben dazu machen.

FAQ

Q: Why is there still some flow coming out of the tube although the HoseGuard® did activate?

A: The HoseGuard® is equipped with a [“reset”](#) function to allow an automatic reset once the broken hose has been repaired. That free flow is essential for the reset function.

Q: Can I use the HoseGuard® for more mediums than air?

A: The Medium cannot be liquid, flammable or of an aggressive kind. Only compressed air and nitrogen can be used.

Q: Why is the HoseGuard® not working?

A: Please refer to the Troubleshooting section and follow the instructions.





Q: How long can be the hose after the HoseGuard®

A: There is no Guideline, as each hose has its own characteristics. There is a general inner diameter to take in consideration (1/4“= 6mm, 3/8“= 10mm, 1/2“= 13mm, 3/4“= 16mm, 1“=19mm). If a long hose is assembled, you have to use wider inner diameters, and test for the function accordingly.

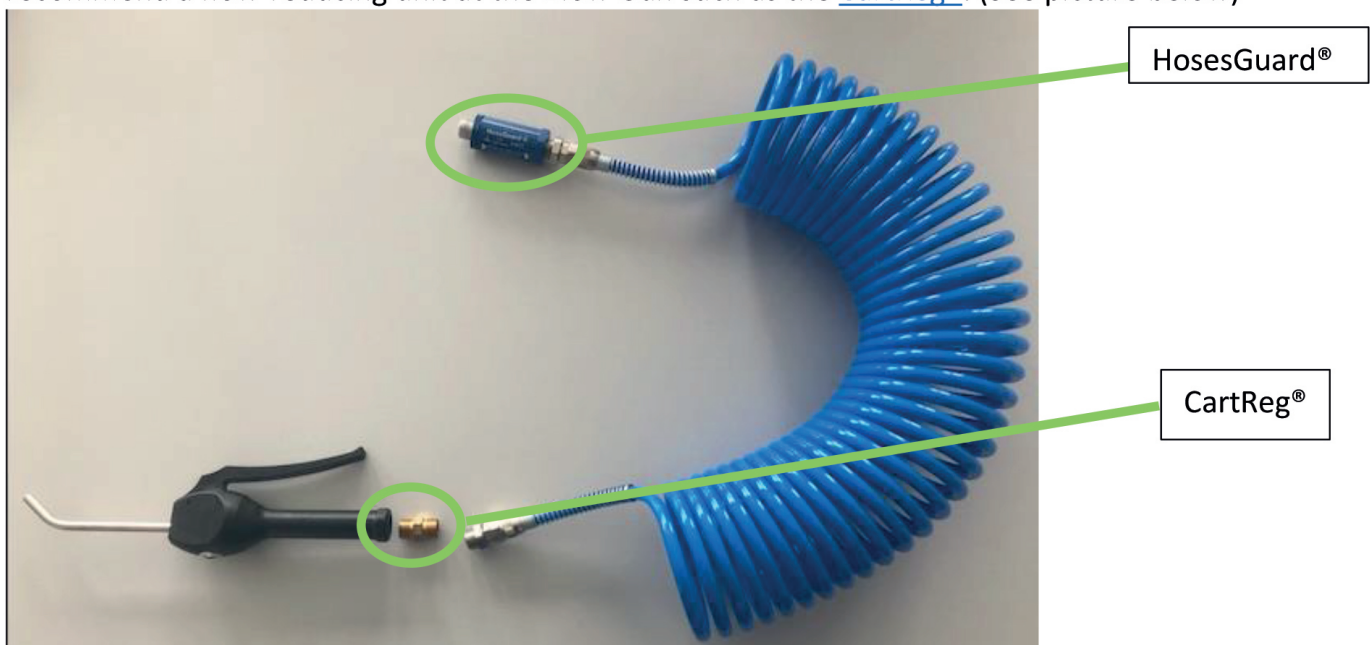
Q: With a Blow Gun the HoseGuard® constantly activates, why is that?

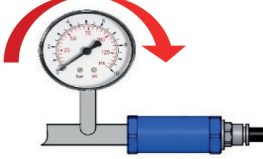
A: The Function of a Blow Gun (Air Gun) is to release the air instantly upon activation of the trigger. This instant release of airflow is equivalent to a hose/tube rupturing, hence the HoseGuard® will activate every time the Blow Gun is triggered. To overcome this obstacle we recommend a flow-reducing unit at the Blow Gun such as the [CartReg®](#): (See picture below)

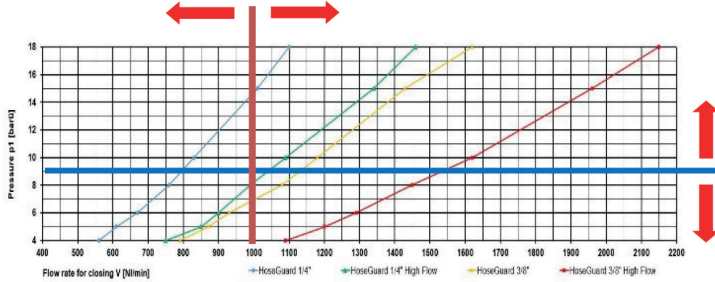
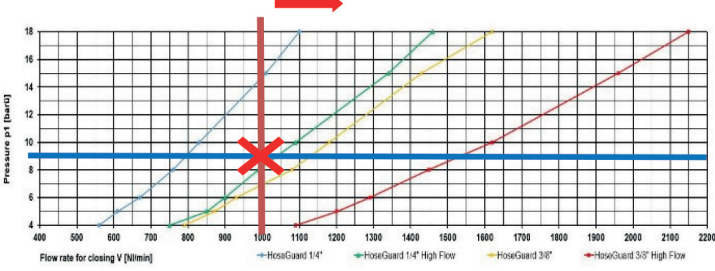

Easy HoseGuard® finder	NI/min - bar
<p>1</p> 	<p>Determine the operating pressure at the place where the later use of the the HoseGuard® is planned.</p>
<p>2</p> 	<p>Measure the air consumption of the consumer at operating pressure.</p>
<p>3</p> 	<p>Add a safety allowance of 20% to the air consumption of the consumer!</p>
<p>4</p> 	<p>Determine the intersection point of the operating pressure and air consumption in the table (see back).</p>
<p>5</p> 	<p>The first curve on the right of the intersection point is our HoseGuard®. In our example the green curve = 1/4" High Flow.</p>
<p>6</p>  <p>Observe the Installation and operation instructions</p>	<p>Install the defined HoseGuard® and test the function of the tool; then perform a function test in accordance with the operating instructions.</p>
<p>Important</p> <ul style="list-style-type: none"> • The interior tube cross-sections in front of the HoseGuard® must be larger than or equal to the interior diameter of the HoseGuard®. (The HoseGuard® nominal widths are for 1/4" = 6 mm, 3/8" = 10 mm, 1/2" = 12 mm, 3/4" = 19 mm, 1" = 25 mm). • The following figures must be observed as the minimum interior hose diameter: 1/4" = 6 mm, 3/8" = 10 mm, 1/2" = 13 mm, 3/4" = 16 mm / 1" = 19 mm. • Extremely long hoses may cause a high pressure drop at the end of the hose. This must be accounted for during planning. Please consider that we need sufficient flow to enable the HoseGuard® to close! 	



Closing point tables

HoseGuard®

- 1/4"
- 3/8"
- 1/2"
- 3/4"
- 1"

