

# Panel Mounting Actuators with Technopolymer Body

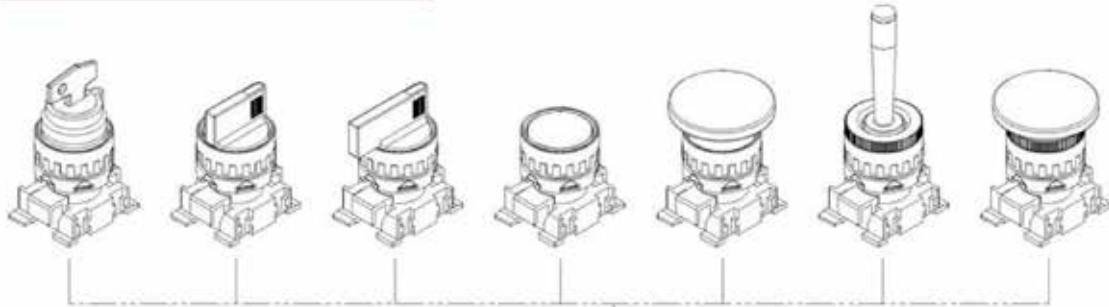

### Drilling measures

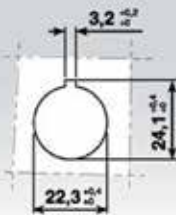

LINE 100



LINE 120  
LINE 127



LINE 120  
LINE 125  
LINE 127

2 Positions key selector. Technopolymer body, round front element.



POSITION	CODE	REF.
	2038-7296	RT201N

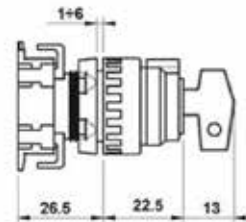

2 - 3 Positions short lever selector. Technopolymer body, round front element.



POSITION	CODE	REF.
	2038-7304	RT300N

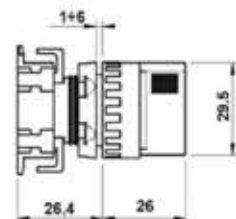

2 - 3 Positions long lever selector.  
Technopolymer body, round front  
element.



POSITION	CODE	REF.
	2038-7346	RT400N

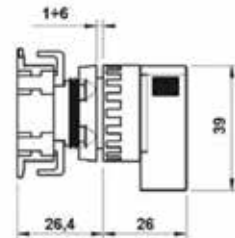

Protected push button. Technopolymer  
body, round front element.



COLOR	CODE	REF.
white	2038-7411	WHITE COVER
black	2038-7403	BLACK COVER
red	2038-7395	RED COVER
green	2038-7445	GREEN COVER

\*Provided without cover

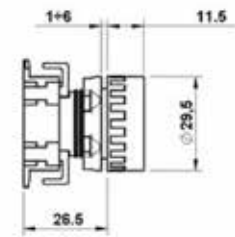

Axial mushroom. Technopolymer  
body, round front element.



COLOR	CODE	REF.
red	2038-7510	RT050R
black	2038-7528	RT050N

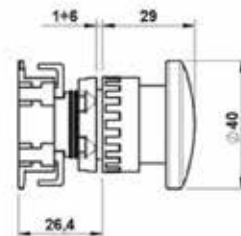

Axial mushroom with turn reset.  
Technopolymer body, round front  
element.



COLOR	CODE	REF.	DIAM.
red	2038-7585	2 RT 065R-40	40 mm

