

Standard valves to ISO 15218

FESTO

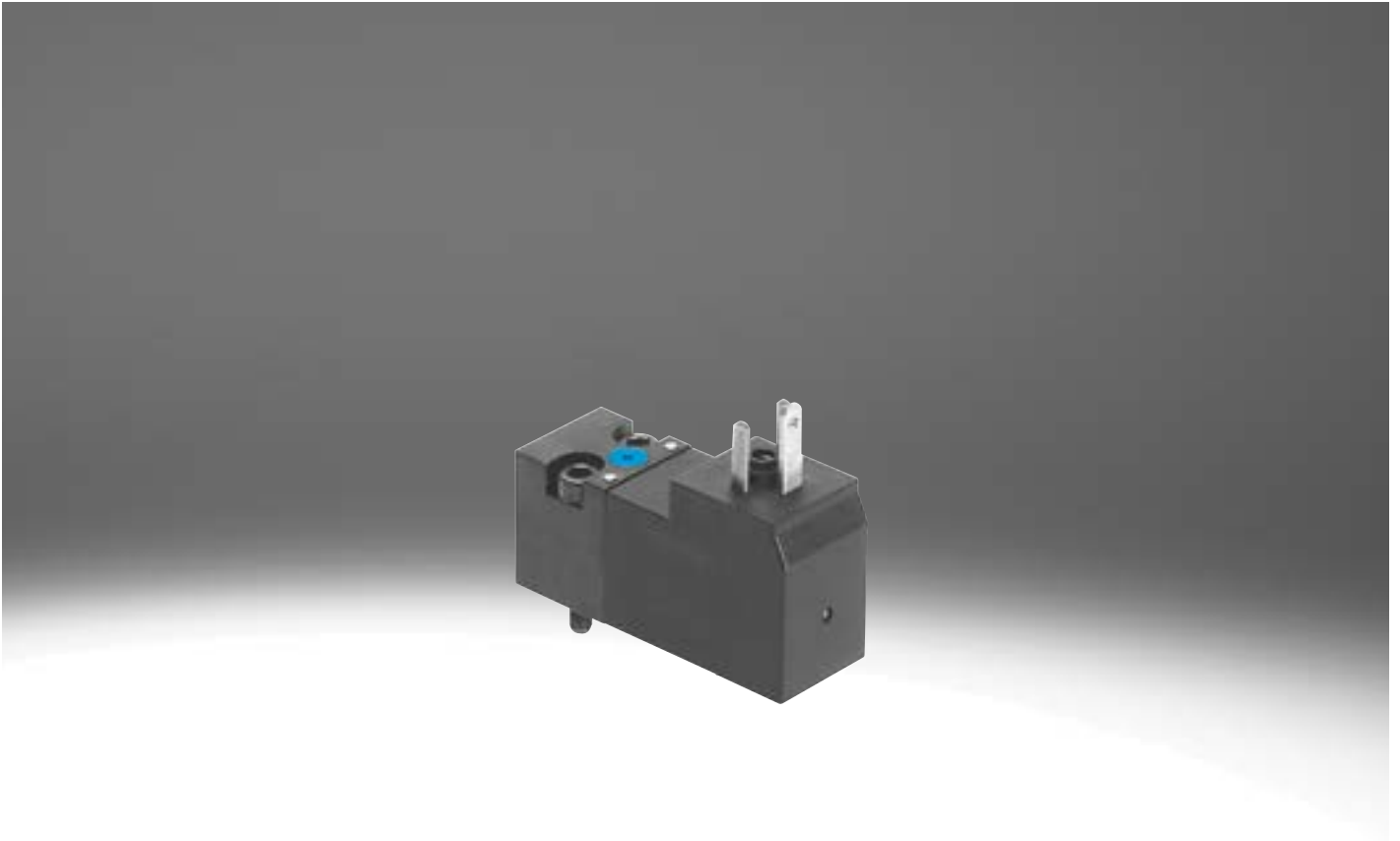

Product range overview

Function	Electrical connection		Voltage	Manual override	→ Page/Internet		
Pilot valve to ISO 15218	Width 15 mm						
	Plug type C, to EN 175301-803	-	12 V DC	Non-detenting	4		
				Non-detenting/detenting	4		
				24 V DC	Non-detenting	4	
					Non-detenting/detenting	4	
				24 V AC	Non-detenting	4	
					Non-detenting/detenting	4	
			With PE conductor	-	110 V AC	Non-detenting	4
						Non-detenting/detenting	4
					230 V AC	Non-detenting	4
						Non-detenting/detenting	4
	M12 plug to IEC 61076-2-101	-	24 V DC	Non-detenting	8		
				Non-detenting/detenting	8		
	Width 30 mm						
	Plug type A, to EN 175301-803	-		24 V DC/42 V AC	Non-detenting	11	
24 V DC/48 V AC				Non-detenting	11		
110 V AC				Non-detenting	11		
230 V AC				Non-detenting	11		

Type codes

001	Series	
VSCS	Standards-based valve to ISO 15218	

002	Directional control valve type	
B	Sub-base valve	

003	Valve function	
M32	3/2-way solenoid valve	

004	Reset method for monostable/single solenoid valves	
M	Mechanical spring	

005	Manual override	
D	Non-detenting, detenting	
H	Non-detenting	

006	Pneumatic connection	
WA	CNOMO interface, small	

007	Nominal operating voltage	
1	24 V DC	
1A	24 V AC/50-60 Hz	
2A	110 V AC/50-60 Hz	
3A	230 V AC/50-60 Hz	
5	12 V DC	

008	Electrical connection	
C1	Plug pattern type C, to EN 175301-803	

009	Pressure range [MPa]	
	0 ... 1	
8	0.15 ... 0.8	

Data sheet

Standard valve with plug type C VSCS-B-M32-...C1

- Valve actuator for electrical actuation of valve bodies
- Pneumatic connection: to ISO 15218 (CNOMO)
- Electrical connection to EN 175301-803, type C



General technical data			
Operating pressure	0.15 ... 0.8 MPa	0 ... 1 MPa	
Electrical connection	Plug type C (without PE conductor), to EN 175301-803		
Valve function	3/2-way single solenoid valve, normally closed		
Sealing principle	Soft		
Actuation type	Electrical		
Reset method	Mechanical spring		
Type of control	Direct		
Flow direction	Non-reversible		
Overlap	Negative overlap		
Width [mm]	15		
Mounting position	Any		
Mounting	Screwed to valve body or sub-base (2x M3)		
Standard nominal flow rate [l/min]	13.5	18	
Duty cycle [%]	100		
Degree of protection to EN 60529	IP65 (in combination with plug socket)		
Conforms to standard	ISO 15218		

Characteristic coil data – Operating pressure 0.15 ... 0.8 MPa						
Operating voltage		12 V DC	24 V DC	24 V AC	110 V AC	230 V AC
Frequency [Hz]		–	–	50/60	50/60	50/60
Power [W]		1.3	1.3	–	–	–
Pick-up power [VA]		–	–	2.1	2.0	1.9
Holding power [VA]		–	–	1.6	1.5	1.3
Switching time	On [ms]	8	8	9	8	8
	Off [ms]	6	6	30	20	35
Permissible voltage fluctuation [%]		–10/+10	–10/+10	–10/+10	–10/+10	–10/+10

Characteristic coil data – Operating pressure 0 ... 1 MPa						
Operating voltage		12 V DC	24 V DC	24 V AC	110 V AC	230 V AC
Frequency [Hz]		–	–	50/60	50/60	50/60
Power [W]		1.8	1.8	–	–	–
Pick-up power [VA]		–	–	3.1	2.9	2.9
Holding power [VA]		–	–	2.3	2.1	2.1
Switching time	On [ms]	6	6	6	6	6
	Off [ms]	6	6	6	6	6
Permissible voltage fluctuation [%]		–15/+10	–15/+10	–15/+10	–15/+10	–15/+10

Materials	
Seals	NBR
Note on materials	RoHS-compliant

Data sheet

Safety data – Operating pressure 0.15 ... 0.8 MPa					
Operating voltage	12 V DC	24 V DC	24 V AC	110 V AC	230 V AC
Note on forced checking procedure	Switching frequency min. 1/week				
Shock resistance	Shock test with severity level 1 to FN 942017-5 and EN 60068-2-27				
Vibration resistance	Transport application test with severity level 1 to FN 942017-4 and EN 60068-2-6				

Safety data – Operating pressure 0 ... 1 MPa					
Operating voltage	12 V DC	24 V DC	24 V AC	110 V AC	230 V AC
Note on forced checking procedure	Switching frequency min. 1/week				
Maximum positive test pulse with 0 signal [μs]	–	1800	–	–	–
Maximum negative test pulse with 1 signal [μs]	–	800	–	–	–
Shock resistance	Shock test with severity level 2 to FN 942017-5 and EN 60068-2-27				
Vibration resistance	Transport application test with severity level 2 to FN 942017-4 and EN 60068-2-6				

Operating and environmental conditions – Operating pressure 0.15 ... 0.8 MPa					
Operating voltage	12 V DC	24 V DC	24 V AC	110 V AC	230 V AC
Operating medium	Compressed air to ISO 8573-1:2010 [7:4:4]				
Note on the operating/pilot medium	Lubricated operation possible (in which case lubricated operation will always be required)				
Operating pressure [bar]	1.5 ... 8				
Ambient temperature [°C]	–5 ... +50				
Temperature of medium [°C]	–5 ... +50				
Corrosion resistance class CRC ¹⁾	2				
CE marking (see declaration of conformity) ²⁾	–	–	–	To EU Low Voltage Directive	

1) Corrosion resistance class CRC 2 to Festo standard FN 940070

Moderate corrosion stress. Indoor applications in which condensation can occur. External visible parts with primarily decorative surface requirements which are in direct contact with a normal industrial environment.

2) Additional information: www.festo.com/catalogue/... → Support/Downloads.

Operating and environmental conditions – Operating pressure 0 ... 1 MPa					
Operating voltage	12 V DC	24 V DC	24 V AC	110 V AC	230 V AC
Operating medium	Compressed air to ISO 8573-1:2010 [7:4:4]				
Note on the operating/pilot medium	Lubricated operation possible (in which case lubricated operation will always be required)				
Operating pressure [bar]	0 ... 10				
Ambient temperature [°C]	–10 ... +50				
Temperature of medium [°C]	–10 ... +50				
Corrosion resistance class CRC ¹⁾	2				
CE marking (see declaration of conformity) ²⁾	–	–	–	To EU Low Voltage Directive	
Certification	–	c UL us - Recognized (OL)	–	–	–

1) Corrosion resistance class CRC 2 to Festo standard FN 940070

Moderate corrosion stress. Indoor applications in which condensation can occur. External visible parts with primarily decorative surface requirements which are in direct contact with a normal industrial environment.

2) Additional information: www.festo.com/catalogue/... → Support/Downloads.

Data sheet

Dimensions

VSCS-...C1

Download CAD data → www.festo.com

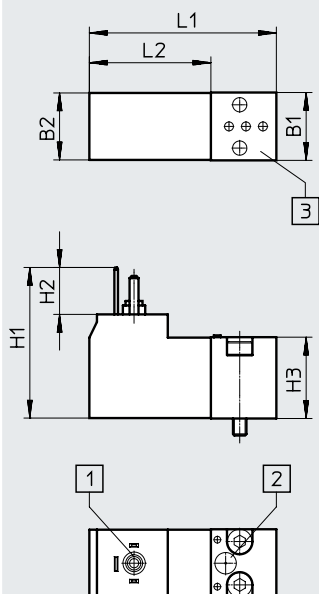

- [1] Plug type C, to EN 175301-803
- [2] Manual override
- [3] Pneumatic port pattern to ISO 15218

Electrical connection

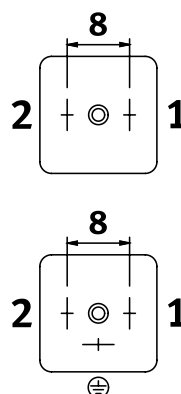

Operating voltage:

- 12 V DC
- 24 V DC
- 24 V AC

Operating voltage:

- 110 V AC
- 230 V AC

Type	B1	B2	H1	H2	H3	L1	L2
VSCS-...C1	15.2	15	33.7	10.5	18.2	41.9	14.7

Ordering data

	Operating voltage	Manual override	Part no.	Type	
Operating pressure 0.15 ... 0.8 MPa					
	12 V DC	Non-detenting	8040565	VSCS-B-M32-MH-WA-5C1-8	
		Non-detenting/detenting	8040571	VSCS-B-M32-MD-WA-5C1-8	
	24 V DC	Non-detenting	8040564	VSCS-B-M32-MH-WA-1C1-8	
		Non-detenting/detenting	8040570	VSCS-B-M32-MD-WA-1C1-8	
	24 V AC	Non-detenting	8040566	VSCS-B-M32-MH-WA-1AC1-8	
		Non-detenting/detenting	8040572	VSCS-B-M32-MD-WA-1AC1-8	
	110 V AC	Non-detenting	8040567	VSCS-B-M32-MH-WA-2AC1-8	
		Non-detenting/detenting	8040573	VSCS-B-M32-MD-WA-2AC1-8	
	230 V AC	Non-detenting	8040568	VSCS-B-M32-MH-WA-3AC1-8	
		Non-detenting/detenting	8040574	VSCS-B-M32-MD-WA-3AC1-8	
	Operating pressure 0 ... 1 MPa				
		12 V DC	Non-detenting	546257	VSCS-B-M32-MH-WA-5C1
Non-detenting/detenting			571062	VSCS-B-M32-MD-WA-5C1	
24 V DC		Non-detenting	546256	VSCS-B-M32-MH-WA-1C1	
		Non-detenting/detenting	571061	VSCS-B-M32-MD-WA-1C1	
24 V AC		Non-detenting	546258	VSCS-B-M32-MH-WA-1AC1	
		Non-detenting/detenting	571063	VSCS-B-M32-MD-WA-1AC1	
110 V AC		Non-detenting	546259	VSCS-B-M32-MH-WA-2AC1	
		Non-detenting/detenting	571064	VSCS-B-M32-MD-WA-2AC1	
230 V AC		Non-detenting	546260	VSCS-B-M32-MH-WA-3AC1	
		Non-detenting/detenting	571065	VSCS-B-M32-MD-WA-3AC1	

Type codes

001	Series	
VSCS	Standards-based valve to ISO 15218	

002	Directional control valve type	
B	Sub-base valve	

003	Valve function	
M32	3/2-way solenoid valve	

004	Reset method for monostable/single solenoid valves	
M	Mechanical spring	

005	Manual override	
D	Non-detenting, detenting	
H	Non-detenting	

006	Pneumatic connection	
WA	CNOMO interface, small	

007	Nominal operating voltage	
1	24 V DC	

008	Electrical connection	
R3	Individual plug M12, to EN 61076-2-101	

009	Pressure range [MPa]	
	0 ... 1	
8	0.15 ... 0.8	

Data sheet

Standard valve with round plug VSCS-B-M32 ... 1R3

- Valve actuator for electrical actuation of valve bodies
- Pneumatic connection: to ISO 15218 (CNOMO)
- Electrical connection M12x1 to IEC 61076-2-101



General technical data		
Operating pressure	0.15 ... 0.8 MPa	0 ... 1 MPa
Electrical connection	Plug M12x1, to IEC 61076-2-101	
Valve function	3/2-way single solenoid valve, normally closed	
Sealing principle	Soft	
Actuation type	Electrical	
Reset method	Mechanical spring	
Type of control	Direct	
Flow direction	Non-reversible	
Overlap	Negative overlap	
Width [mm]	15	
Mounting position	Any	
Mounting	Screwed to valve body or sub-base (2x M3)	
Standard nominal flow rate [l/min]	13.5	18
Duty cycle [%]	100	
Degree of protection to EN 60529	IP65 (in combination with plug socket)	
Conforms to standard	ISO 15218	

Characteristic coil data		
Operating pressure	0.15 ... 0.8 MPa	0 ... 1 MPa
Operating voltage [V DC]	24	24
Power [W]	1.3	1.8
Switching time	On [ms]	8
	Off [ms]	6
Permissible voltage fluctuation [%]	-10/+10	-15/+10

Materials	
Seals	NBR
Note on materials	RoHS-compliant

Safety characteristics		
Operating pressure	0.15 ... 0.8 MPa	0 ... 1 MPa
Note on forced checking procedure	Switching frequency min. 1/week	Switching frequency min. 1/week
Max. positive test pulse with 0 signal [μs]	-	1800
Max. negative test pulse with 1 signal [μs]	-	800
Shock resistance	Shock test with severity level 1 to FN 942017-5 and EN 60068-2-27	Shock test with severity level 2 to FN 942017-5 and EN 60068-2-27
Vibration resistance	Transport application test with severity level 1 to FN 942017-4 and EN 60068-2-6	Transport application test with severity level 2 to FN 942017-4 and EN 60068-2-6

Data sheet

Operating and environmental conditions		
Operating pressure	0.15 ... 0.8 MPa	0 ... 1 MPa
Operating medium	Compressed air to ISO 8573-1:2010 [7:4:4]	
Note on the operating/pilot medium	Lubricated operation possible (in which case lubricated operation will always be required)	
Operating pressure [bar]	1.5 ... 8	0 ... 10
Ambient temperature [°C]	-5 ... +50	-10 ... +50
Temperature of medium [°C]	-5 ... +50	-10 ... +50
Corrosion resistance class CRC ¹⁾	2	2
Certification	-	c UL us - Recognized (OL)

1) Corrosion resistance class CRC 2 to Festo standard FN 940070

Moderate corrosion stress. Indoor applications in which condensation can occur. External visible parts with primarily decorative surface requirements which are in direct contact with a normal industrial environment.

Dimensions

Download CAD data → www.festo.com

VSCS-...1R3

Electrical connection

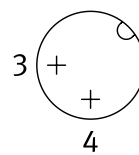
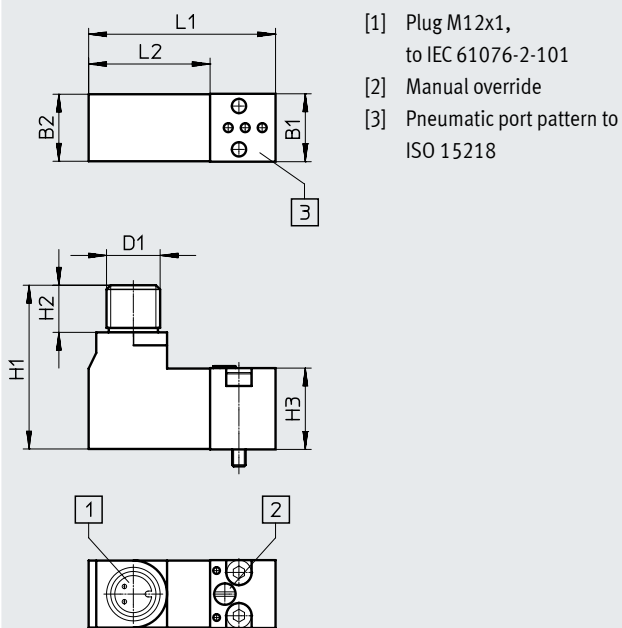

Type	B1	B2	D1	H1	H2	H3	L1	L2
VSCS-...1R3	15.2	15	M12	36.7	10.6	18.2	41.9	27.2

Ordering data				
	Operating pressure	Manual override	Part no.	Type
	0.15 ... 0.8 MPa	Non-detenting	8040569	VSCS-B-M32-MH-WA-1R3-8
		Non-detenting/detenting	8040575	VSCS-B-M32-MD-WA-1R3-8
	0 ... 1 MPa	Non-detenting	573214	VSCS-B-M32-MH-WA-1R3
		Non-detenting/detenting	573215	VSCS-B-M32-MD-WA-1R3

Type codes

001	Series
MDH	Standards-based directional control valve

002	Valve function
3/2	3/2-way valve

003	Nominal operating voltage
	24 V DC, 42 V AC 50/60 Hz
24DC	24 V DC, 48 V AC 50/60 Hz
110VAC	110 V AC, 50/60 Hz
230VAC	230 V AC, 50/60 Hz

Data sheet

**Standard valve with plug type A
MDH-3/2 ...**

- Valve actuator for electrical actuation of valve bodies
- Pneumatic connection: to ISO 15218 (CNOMO)
- Electrical connection, plug type A, to EN 175301-803

**General technical data**

Electrical connection	Plug type A, to EN 175301-803
Valve function	3/2-way single solenoid valve, normally closed
Sealing principle	Soft-sealing
Actuation type	Electrical
Reset method	Mechanical spring
Design	Poppet valve
Type of control	Direct
Flow direction	Non-reversible
Overlap	Negative overlap
Width [mm]	30
Mounting position	Any
Mounting	Screwed to basic valve body or sub-base
Manual override	Non-detenting
Standard nominal flow rate [l/min]	50
Duty cycle [%]	100
Degree of protection to EN 60529	IP65 (in combination with plug socket)
Conforms to standard	ISO 15218
Weight [g]	140

Characteristic coil data

Operating voltage		42 V AC	48 V AC	110 V AC	230 V AC
Operating voltage	[V AC]	42	48	110	230
	[V DC]	24	24	–	–
	[Hz]	50/60	50/60	50/60	50/60
Power	[W]	8.4	6	–	–
Pick-up power	[VA]	11.5	14.5	12	12
Holding power	[VA]	8.5	9.9	8	8
Switching time on/off	[ms]	11/9	11/9	11/9	11/9
Permissible voltage fluctuation	[%]	–10/+10	–10/+10	–10/+10	–10/+10
Permissible frequency fluctuation	[%]	–10/+10	–	–10/+10	–10/+10

Materials

Seals	FPM
Note on materials	RoHS-compliant

Data sheet

Operating and environmental conditions		42 V AC	48 V AC	110 V AC	230 V AC
Operating medium	Compressed air to ISO 8573-1:2010 [7:4:4]				
Note on the operating/pilot medium	Lubricated operation possible (in which case lubricated operation will always be required)				
Operating pressure [bar]	1 ... 16				
Ambient temperature [°C]	-10 ... +50			-15 ... +50	
Temperature of medium [°C]	-15 ... +80			-15 ... +80	
Corrosion resistance class CRC ¹⁾	2			2	
CE marking (see declaration of conformity) ²⁾	-			To EU Low Voltage Directive	

1) Corrosion resistance class CRC 2 to Festo standard FN 940070

Moderate corrosion stress. Indoor applications in which condensation can occur. External visible parts with primarily decorative surface requirements which are in direct contact with a normal industrial environment.

2) Additional information: www.festo.com/catalogue/... → Support/Downloads.

Dimensions

MDH-3/2 ...

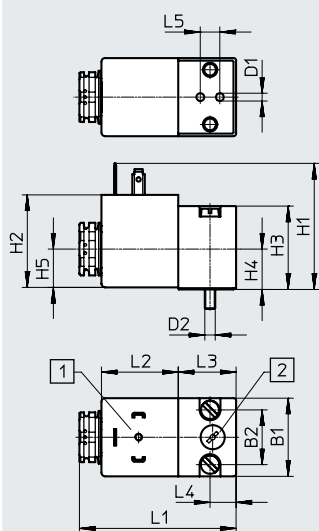

- [1] Plug type A, to EN 175301-803
- [2] Manual override

Download CAD data → www.festo.com

Electrical connection

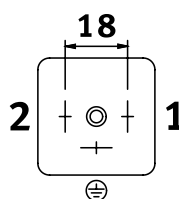

Type	B1	B2	D1	D2	H1	H2	H3	H4	H5	L1	L2	L3	L4	L5
MDH-3/2 ...	30	21	3	M4	48.4	35.5	32	15.5	14.7	60.7	29.5	22	10	7.5

Ordering data

	Operating voltage		Part no.	Type
	24 V DC	42 V AC	119603	MDH-3/2-24VDC/42VAC
		48 V AC	119600	MDH-3/2-24DC
	110 V AC		119601	MDH-3/2-110VAC
230 V AC		119602	MDH-3/2-230VAC	