

Round cylinders DSNU

FESTO



Festo Core Range
Solves the majority of your automation tasks

Worldwide: Quickest delivery – wherever, whenever
Simply good: Expected high Festo quality
Fast: Easy and fast to select

With the Festo Core Range, we have selected the most important products and functions from our broad product catalogue, and added the quickest delivery.

The Core Range offers you the best value for your automation tasks.

Just look
for the
star!

Key features

At a glance

DSNU-8 ... 63

- Stainless steel piston rod
- Good running performance and long service life
- Piston rod with male and female thread

- Extensive range of accessories makes it possible to install the cylinder virtually anywhere

DSNU-8 ... 25



- The basic versions conform to ISO 6432, variants are based on these standards

Wide choice of variants

DSNU	DSNU-...-MA	DSNU-...-MQ	DSNU-...-MH
<ul style="list-style-type: none"> • Piston \varnothing 8 ... 63 mm • Cylinder barrel made of stainless steel • Bearing and end caps made of wrought aluminium alloy 	<ul style="list-style-type: none"> • Piston \varnothing 8 ... 63 mm • Cylinder barrel made of stainless steel • Bearing cap with threaded flange • Short end cap with axial supply port 	<ul style="list-style-type: none"> • Piston \varnothing 8 ... 63 mm • Cylinder barrel made of stainless steel • Bearing cap with threaded flange • Short end cap with lateral supply port 	<ul style="list-style-type: none"> • Piston \varnothing 8 ... 63 mm • Cylinder barrel made of stainless steel • Direct mounting on bearing cap • Short end cap with lateral supply port



DSNU-...-KP

- Piston \varnothing 8 ... 63 mm
- Cylinder barrel made of stainless steel
- With clamping unit



DSNU-...-Q











- Piston \varnothing 12 ... 63 mm
- Cylinder barrel made of stainless steel
- With square piston rod



Cushioning types

	Cushioning P	Cushioning PPS	Cushioning PPV
Mode of operation	<ul style="list-style-type: none"> • The drive has elastic polymer flexible end-position cushioning 	<ul style="list-style-type: none"> • The drive has self-adjusting end-position cushioning 	<ul style="list-style-type: none"> • The drive has adjustable end-position cushioning
Application	<ul style="list-style-type: none"> • Small loads • Low speeds • Low impact energies 	<ul style="list-style-type: none"> • Small to medium loads • Low to medium speeds • Medium impact energies 	<ul style="list-style-type: none"> • Medium to high loads • High speeds • High impact energies
Advantages	<ul style="list-style-type: none"> • No adjustment required • Saves time 	<ul style="list-style-type: none"> • No adjustment required • Saves time • Powerful 	<ul style="list-style-type: none"> • Very powerful

Key features

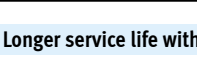
Other variants Symbol	Key features	Description
	S2 Through piston rod	For working at both ends with the same force in the forward and return stroke, for attaching external stops
	S6 Heat-resistant seals	Temperature resistance up to max. 120°C
	S10 Constant motion at low piston speeds	Suitable for very slow and constant (slow speed) and stick-slip-free movements. With very low break-away pressure compared with standard (low friction).
	S11 Low friction	Especially suitable for slow movements with considerably reduced system friction. With very low break-away pressure compared with standard.
	K2 Extended male piston rod thread	–
	K3 Female piston rod thread	–
	K5 Custom piston rod thread	Metric standard thread to ISO
	K6 Shortened male piston rod thread	–
	K8 Extended piston rod	–
	R3 High corrosion protection	All external cylinder surfaces comply with corrosion resistance class CRC 3 to Festo standard 940070. The piston rod is made from corrosion- and acid-resistant steel
	R8 Dust protection (wiper seal) (32 ... 63 mm)	The cylinder has a hard-chrome-plated piston rod and a hard wiper seal, which protects against dry, dusty media
	A6 Metal scraper (32 ... 63 mm)	The cylinder has a hard-chrome-plated piston rod and a metal scraper that scrapes off hard particles (e.g. welding spatter) that stick to the piston rod. For use in welding systems, for example

Longer service life with bellows kit DADB



The bellows protects the piston rod, the seal and the bearing from the effects of a wide range of media, which has a positive impact on the service life of these components.

The bellows kit is a leak-free system. To prevent unwanted media from being drawn in, the supply and exhaust air for the kit must be ducted via a pressure compensation hole in the connection part [1].

The kit protects the piston rod, seal and bearing against a wide variety of media, for example:

- Dust
- Chippings
- Oil
- Grease
- Fuel

Product range overview

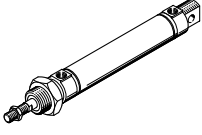
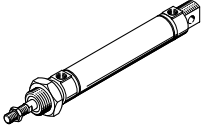
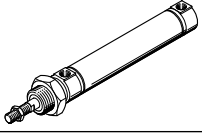
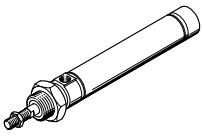
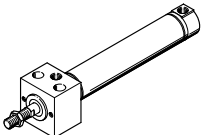
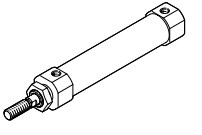
Function	Design	Piston \varnothing [mm]	Stroke [mm]	Variable stroke ¹⁾ [mm]	Piston rod					Female thread K3	
					Through S2	Extended K8	Male thread				
							Extended K2	Shortened K6	Custom thread K5		
Double-acting	DSNU-... – Cylinder barrel made of stainless steel										
		8, 10	10, 15, 20, 25, 30,	1 ... 100							
		12, 16	35, 40, 50, 60, 70,	1 ... 200							
		20	80, 100, 125, 150,	1 ... 320							
		25	160, 200, 250,	1 ... 500	■	■	■	■	■	■	
		32, 40, 50, 63	300, 320, 400, 500								
			25, 40, 50, 80,	1 ... 500							
			100, 125, 160,								
			200, 250, 320								
	DSNU-Q-... – Protected against rotation										
		12, 16	–	5 ... 160							
		20	–	5 ... 200							
		25	–	5 ... 250	■	■	■	■	■	■	
		32	–	5 ... 300							
		40, 50	–	5 ... 400							
63		–	5 ... 500								
DSNU-MQ-... – Lateral supply port, short end cap											
	8, 10	–	1 ... 100								
	12, 16	–	1 ... 200	–	■	■	■	■	■	■	
	20	–	1 ... 320								
	25	–	1 ... 500								
	32, 40, 50, 63	–	1 ... 500								
DSNU-MA-... – Axial supply port, short end cap											
	8, 10	–	1 ... 100								
	12, 16	–	1 ... 200								
	20	–	1 ... 320	–	■	■	■	■	■	■	
	25	–	1 ... 500								
	32, 40, 50, 63	–	1 ... 500								
DSNU-MH-... – Direct mounting											
	8, 10	–	1 ... 100								
	12, 16	–	1 ... 200								
	20	–	1 ... 320	■	■	■	■	■	■	■	
	25	–	1 ... 500								
	32, 40, 50, 63	–	1 ... 500								
DSNU-S-... – Space-saving											
	8	10, 15, 20, 25, 30,	1 ... 100								
	12	40, 50, 60, 80, 100	1 ... 150								
	16	10, 15, 20, 25, 30,	1 ... 200	–	–	–	–	–	–	–	
	20	40, 50, 60,									
	25	80, 100, 125, 150, 200									

1) Cylinders with position sensing require a minimum stroke of 10 mm to ensure reliable sensing

Product range overview

Piston \varnothing	Cushioning			Position sensing	Clamping unit	Heat-resistant seal	Slow speed (constant motion)	Low friction	Corrosion protection	Dust protection (wiper seal)	Metal scraper	→ Page/ Internet
	Fixed	Adjustable	Self-adjusting									
	P	PPV ²⁾	PPS	A	KP	S6	S10	S11	R3	R8	A6	
DSNU-... – Cylinder barrel made of stainless steel												
8 ... 63	■	■ From \varnothing 16	■ From \varnothing 16	■	■	■	■ From \varnothing 12	■ From \varnothing 12	■ From \varnothing 12	■ From \varnothing 32	■ From \varnothing 32	11
DSNU-Q-... – Protected against rotation												
12 ... 63	■ \varnothing 12 and From \varnothing 32	■ From \varnothing 16	–	■	■	■ From \varnothing 32	–	–	■ From \varnothing 16	–	–	46
DSNU-MQ-... – Lateral supply port												
8 ... 63	■	■ From \varnothing 16	■ From \varnothing 16	■	■	■	–	–	■	■ From \varnothing 32	■ From \varnothing 32	11
DSNU-MA-... – Axial supply port												
8 ... 63	■ From \varnothing 32	–	–	■	■	■	–	–	■	–	■	11
DSNU-MH-... – Direct mounting												
8 ... 63	■	■ From \varnothing 32	–	■	–	■	–	–	■	–	–	11
DSNU-S-... – Space-saving												
8 ... 25	■	–	■ From \varnothing 16	■	–	–	–	–	–	–	–	dsnu-s

2) In the modular product system from \varnothing 12 mm

Product range overview

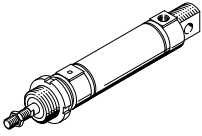
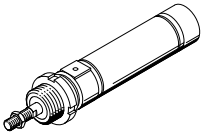
Function	Design	Piston \varnothing	Stroke	Variable stroke ¹⁾	Cushioning Fixed	Position sensing
		[mm]	[mm]	[mm]	P	A
Single-acting	ESNU-... – With position sensing					
		8 ... 63	10, 25, 50	1 ... 50	■	■
Single-acting	ESNU-MA-... – Axial supply port					
		8 ... 63	–	1 ... 50	■	■

1) Cylinders with position sensing require a minimum stroke of 10 mm to ensure reliable sensing

Product range overview

Piston \varnothing	Piston rod					→ Page/ Internet
	Extended K8	Male thread			Female thread K3	
		Extended K2	Shortened K6	Custom thread K5		
ESNU-... – With position sensing						
8 ... 63	■	■	■	■	■	esnu
ESNU-MA-... – Axial supply port						
8 ... 63	■	■	■	■	■	esnu

Peripherals overview

DSNU-...

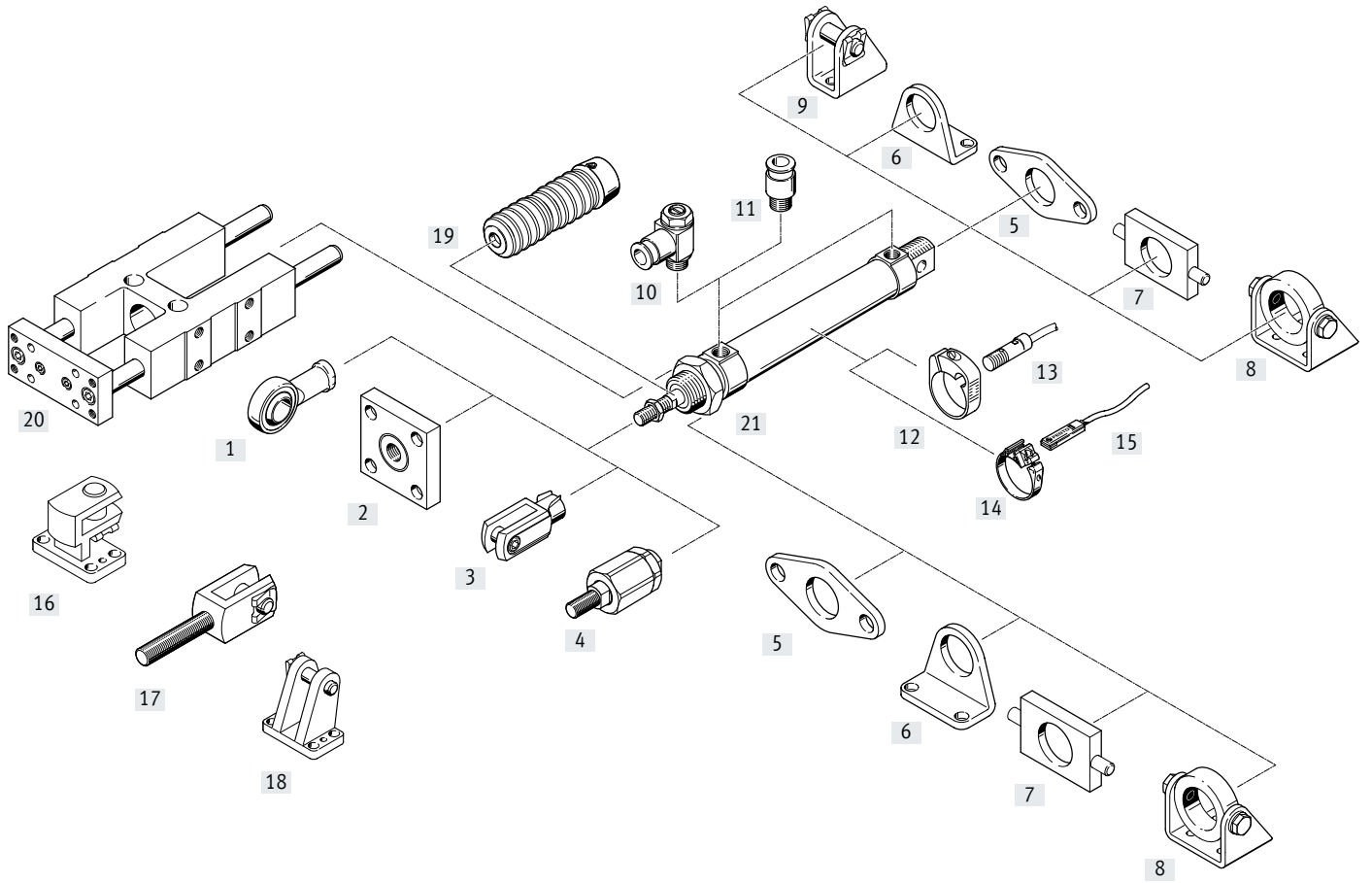

Peripherals overview

Mounting attachments and accessories		Piston \varnothing	DSNU				DSNU-Q	→ Page/ Internet
			MA	MQ	MH	KP		
[1]	Rod eye SGS/CRSGS	8 ... 63	■	■	■	■	■	60
[2]	Coupling piece KSG/KSZ	12 ... 63	■	■	■	■	■	60
[3]	Rod clevis SG/CRSG	8 ... 63	■	■	■	■	■	60
[4]	Self-aligning rod coupler FK/CRFK	8 ... 63	■	■	■	■	■	60
[5]	Flange mounting FBN/CRFBN/CRFV	8 ... 63	■	■	■	–	■	56
[6]	Foot mounting HBN/CRHBN/CRH	8 ... 63	■	■	■	–	■	54
[7]	Swivel mounting ¹⁾ WBN	8 ... 63	■	■	■	–	■	58
[8]	Swivel mounting ¹⁾ SBN	20 ... 63	■	■	■	–	■ \varnothing 20 ... 50	58
[9]	Clevis foot LBN/CRLBN	8 ... 63	■	–	–	–	■	59
[10]	One-way flow control valve GRLA/GRLZ	8 ... 63	■	■	■	■	■	70
[11]	Push-in fitting QS	8 ... 63	■	■	■	■	■	qs
[12]	Mounting kit SMBR/CRSMBR	8 ... 63	■	■	■	■	■	68
[13]	Proximity switch SMEO/SMTO/CRSMEO-4	8 ... 63	■	■	■	■	■	68
[14]	Mounting kit SMBR-8	12 ... 63	■	■	■	■	■	69
[15]	Proximity switch SME/SMT-8	8 ... 63	■	■	■	■	■	69
[16]	Right-angle clevis foot LQG	32 ... 63	■	■	■	■	■	59
[17]	Rod clevis SGA	32 ... 63	■	■	■	■	■	60
[18]	Clevis foot LBG	32 ... 63	■	■	■	■	■	59
[19]	Bellows kit ²⁾ DADB	12 ... 63	■	■	■	–	–	62
[20]	Guide unit FEN	8 ... 25	■	■	■	–	–	61
[21]	Hex nut MSK	16 ... 25	■	■	■	■	■	60

 **Note**

- 1) Cannot be used on the bearing cap in combination with bellows kit DADB.
- 2) The bellows kit protects the cylinder (piston rod, seal and bearings) against a wide range of media and thus prevents premature wear. It can only be used in combination with an extended piston rod (K8)

Type codes

DSNU-...

001	Series	
DSNU	Round cylinder, double-acting, based on ISO 6432	

002	Piston diameter	
8	8	
10	10	
12	12	
16	16	
20	20	
25	25	
32	32	
40	40	
50	50	
63	63	

003	Stroke	
...	1 ... 500	

004	Cushioning	
P	Elastic cushioning rings/plates on both sides	
PPV	Pneumatic cushioning, adjustable at both ends	
PPS	Pneumatic cushioning, self-adjusting at both ends	

005	Position sensing	
	None	
A	For proximity sensor	

006	Cylinder end cap	
	Standard	
MA	Axial air connection, end cap	
MH	Direct mounting, bearing cap	
MQ	Transverse supply port, end cap	

007	Protection against rotation	
Q	Square piston rod	
	None	

008	Piston rod type	
	At one end	
S2	Through piston rod	

009	Piston rod thread extension	
	None	
...K2	1 ... 70 mm	

010	K6 - Shortened male piston rod thread	
	None	
K6	1 ... 10 mm	

011	Piston rod thread type	
	Male thread	
K3	Female thread	

012	Custom thread	
"M10"K5	M10	
"M12"K5	M12	
"M16"K5	M16	

013	Piston rod extension	
	None	
...K8	1 ... 500 mm	

014	Clamping unit	
	None	
KP	attached	

015	Temperature range	
	Standard	
S6	Heat-resistant seals max. 120 °C	

016	Constant motion	
	Standard	
S10	Uniform, slow movement	

017	Running characteristics	
	Standard	
S11	Low friction	

018	Corrosion protection	
	Standard	
R3	High corrosion protection	

019	Scraper variant	
	Standard	
R8	Dust protection	
A6	Metal scraper	

020	EU certification	
	None	
EX4	II 2GD	

Data sheet

P cushioning

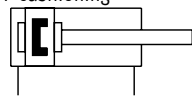

-  Diameter
8 ... 25 mm
ISO 6432

PPV cushioning

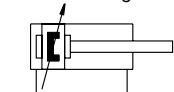

-  Diameter
32 ... 63 mm

PPS cushioning

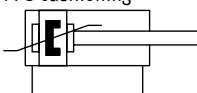

-  Stroke length
1 ... 500 mm,
longer strokes on request



General technical data		8	10	12	16	20	25	32	40	50	63	
Piston \varnothing		8	10	12	16	20	25	32	40	50	63	
Conforms to standard		ISO 6432						-				
Pneumatic connection		M5	M5	M5	M5	G1/8	G1/8	G1/8	G1/4	G1/4	G3/8	
Piston rod thread		M4	M4	M6	M6	M8	M10x1.25	M10x1.25	M12x1.25	M16x1.5	M16x1.5	
Stroke ¹⁾	[mm]	1 ... 100		1 ... 200		1 ... 320	1 ... 500					
Design		Piston/piston rod/cylinder barrel										
Cushioning												
DSNU-...-P		Elastic cushioning rings/plates at both ends										
DSNU-...-PPV		Cushioning, adjustable at both ends										
DSNU-...-PPS		Cushioning, self-adjusting at both ends										
Cushioning length												
DSNU-...-PPV	[mm]	-	9	12	15	17	14	18	20	21		
DSNU-...-PPS	[mm]	-		12	15	17	14	18	20	21		
Position sensing		Via proximity switch										
Type of mounting		Direct mounting (variant MH only)										
		With accessories										
Mounting position		Any										

1) Cylinders with position sensing require a minimum stroke of 10 mm to ensure reliable sensing.
Longer strokes on request

Data sheet

Operating and environmental conditions											
Piston ø	8	10	12	16	20	25	32	40	50	63	
Operating medium	Compressed air to ISO 8573-1:2010 [7:4:4]										
Note on the operating/pilot medium	Lubricated operation possible (in which case lubricated operation will always be required)										
Operating pressure											
DSNU-... [bar]	1.5 ... 10 ¹⁾			1 ... 10							
DSNU-...-S10 [bar]	-		0.5 ... 10	0.3 ... 10			0.2 ... 10				
DSNU-...-S11 [bar]	-		0.45 ... 10	0.3 ... 10			0.2 ... 10				
DSNU-...-A6 [bar]	-							2 ... 10			
Ambient temperature ²⁾											
DSNU-... [°C]	-20 ... +80										
DSNU-...-S6 [°C]	0 ... +120										
DSNU-...-S10 [°C]	+5 ... +80										
DSNU-...-S11 [°C]	+5 ... +80										
DSNU-...-R3 [°C]	-20 ... +80										
DSNU-...-S6-A6 [°C]	-							0 ... +120			
Corrosion resistance class CRC ³⁾											
DSNU-...	2										
DSNU-...-R3	3										

1) For DSNU-12-... PPV (pneumatic cushioning adjustable at both ends): 2 ... 10 bar

2) Note operating range of proximity switches

3) Corrosion resistance class CRC 2 to Festo standard FN 940070

Moderate corrosion stress. Indoor applications in which condensation can occur. External visible parts with primarily decorative surface requirements which are in direct contact with a normal industrial environment.
Corrosion resistance class CRC 3 to Festo standard FN 940070

High corrosion stress. Outdoor exposure under moderate corrosive conditions. Externally visible parts with primarily functional surface requirements which are in direct contact with a normal industrial environment.

ATEX ¹⁾	
ATEX category gas	II 2G
Type of ignition protection for gas	Ex h IIC T4 Gb
ATEX category for dust	II 2D
Type of ignition protection for dust	Ex h IIIC T120°C Db
Explosion-proof ambient temperature	-20°C ≤ Ta ≤ +60°C
CE marking (see declaration of conformity)	To EU Explosion Protection Directive (ATEX)

1) Note the ATEX certification of the accessories.

Weight [g]										
Piston ø	8	10	12	16	20	25	32	40	50	63
Product weight with 0 mm stroke	34.6	37.3	75	89.9	186.8	238	370.5	661	1087	1445
Additional weight per 10 mm stroke	2.4	2.7	4	4.6	7.2	11	15.5	24	40	44
Moving mass with 0 mm stroke	7.5	8.5	18.5	23	44	71	121	230	413	459
Moving mass per 10 mm stroke	1	1	2	2	4	6	9	16	25	25

Data sheet

Speed [mm/s]		16	20	25	32	40	50	63
Piston \varnothing								
Speed with stick-slip-free operation, horizontal, without load, at 6 bar	S10	10 ... 100			8 ... 100			5 ... 100
Minimum speed, advancing	S11	2.7	5.3	<1 ¹⁾				
Minimum speed, retracting	S11	3.2	4.7	<1 ¹⁾				

1) Measurements of less than 1 mm/s were not conducted

Forces [N] and impact energy [J]		8	10	12	16	20	25	32	40	50	63
Piston \varnothing											
Theoretical force at 6 bar, advancing		30	47	68	121	189	295	483	753	1178	1870
Theoretical force at 6 bar, retracting		23	40	51	104	158	247	415	633	990	1682
Impact energy in the end positions for P cushioning ¹⁾		0.03	0.05	0.07	0.15	0.20	0.30	0.40	0.70	1.00	1.30

1) The values are reduced by approx. 50% at an ambient temperature of 80°C

Average piston speed v as a function of payload m in combination with cushioning PPS

Piston \varnothing 16

Piston \varnothing 20

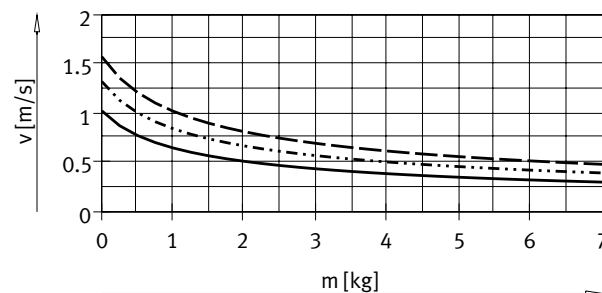
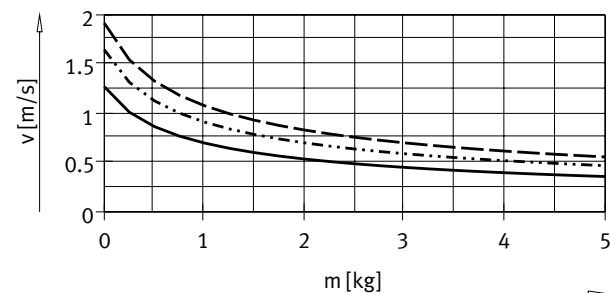

— DSNU-16-50
 DSNU-16-100
 - - - - - DSNU-16-200

— DSNU-20-50
 DSNU-20-100
 - - - - - DSNU-20-200

Piston \varnothing 25

Piston \varnothing 32

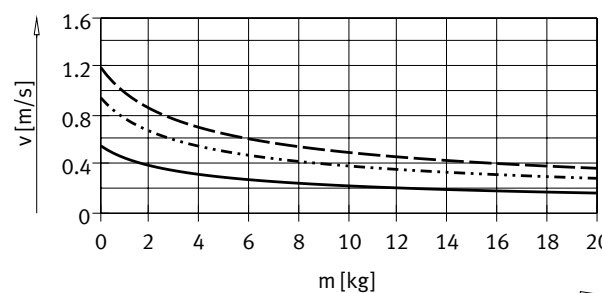
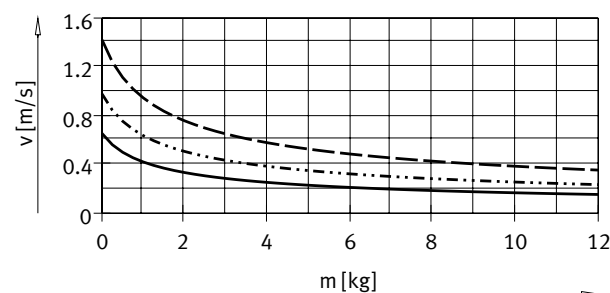

— DSNU-25-50
 DSNU-25-100
 - - - - - DSNU-25-200

— DSNU-32-50
 DSNU-32-100
 - - - - - DSNU-32-200

Data sheet

Average piston speed v as a function of payload m in combination with cushioning PPS

Piston \varnothing 40

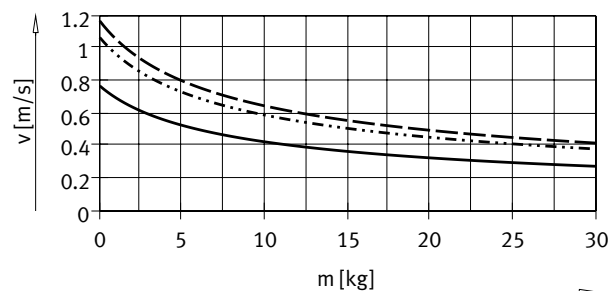

- DSNU-40-50
- DSNU-40-100
- - - DSNU-40-200

Piston \varnothing 50

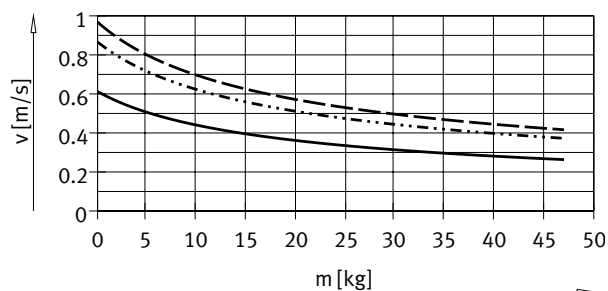

- DSNU-50-50
- DSNU-50-100
- - - DSNU-50-200

Piston \varnothing 63

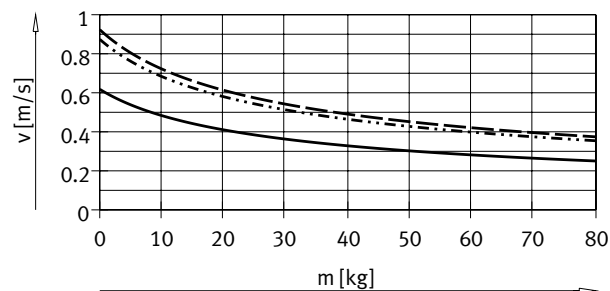

- DSNU-63-50
- DSNU-63-100
- - - DSNU-63-200

Note:

Engineering software for
 P cushioning
 PPV cushioning
 → https://www.festo.com/eap/en_gb/PneumaticSizing/

Average piston speed = Stroke/
 movement time

Additional graphs for
 PPS cushioning
 → www.festo.com

Data sheet

Max. transverse load F_q as a function of projection l

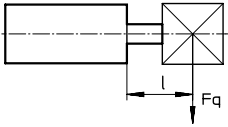

DSNU-...

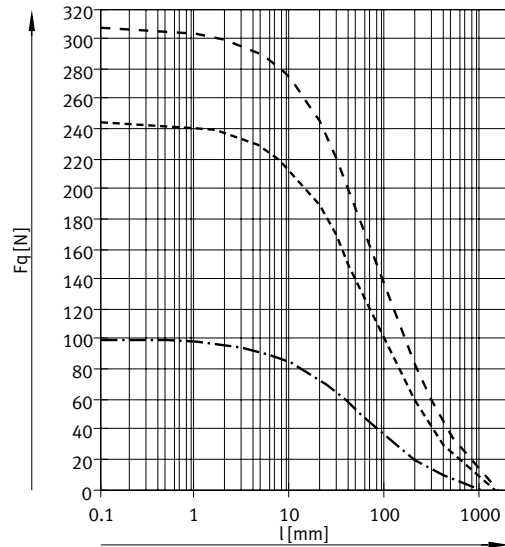
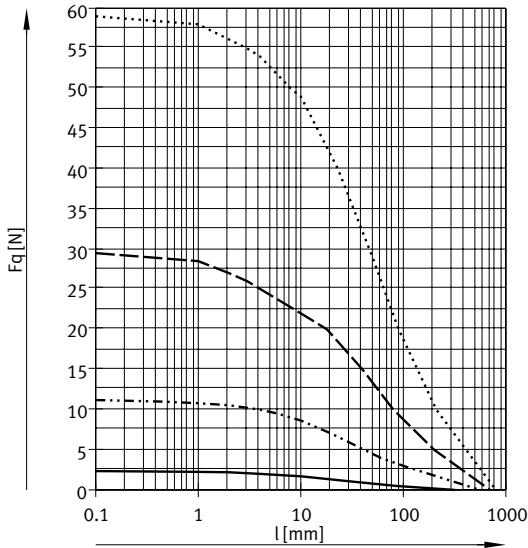

- DSNU-8/10
- - - - DSNU-12/16
- DSNU-20
- DSNU-25

- · - · - DSNU-32
- - - - DSNU-40
- DSNU-50/63

DSNU-...-S2 – Through piston rod

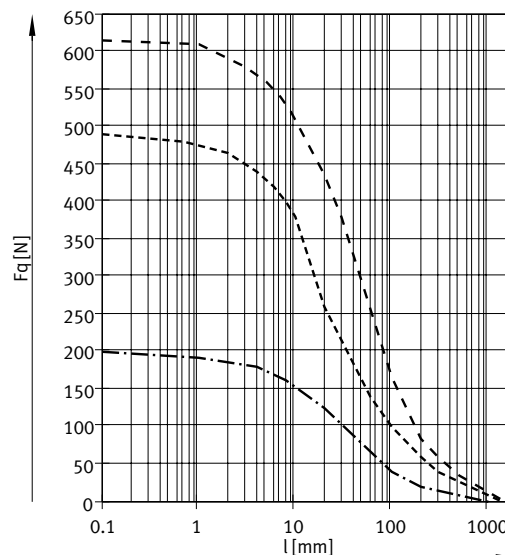
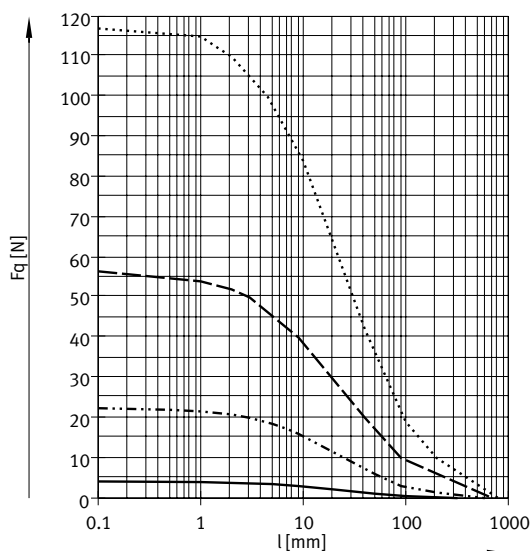

- DSNU-8/10
- - - - DSNU-12/16
- DSNU-20
- DSNU-25

- · - · - DSNU-32
- - - - DSNU-40
- DSNU-50/63

Data sheet

Materials

Sectional view

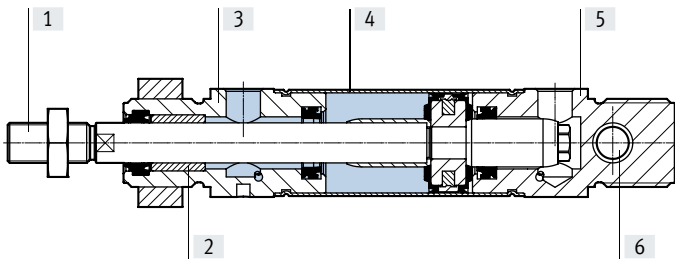

Round cylinder	8 ... 25	32 ... 63
[1] Piston rod		
DSNU-...	High-alloy steel	
DSNU-...-R3	High-alloy stainless steel	
DSNU-...-A6	-	Hard-chrome-plated tempered steel
[2] Piston rod bearing	Sintered bronze	
[3] Bearing cap	Colourless anodised wrought aluminium alloy	
[4] Cylinder barrel	High-alloy stainless steel	
[5] End cap	Colourless anodised wrought aluminium alloy	
- Seals		
DSNU-...	TPE-U(PU), NBR	
DSNU-...-S6	FPM	
DSNU-...-S10	FPM	FPM, TPE-U(PU)
DSNU-...-S11	FPM	FPM, TPE-U(PU)
DSNU-...-R3	TPE-U (PUR) media seal (modified for resistance to hydrolysis and cleaning)	
Piston rod scraper		
DSNU-...-A6	-	CuZn
Note on materials		
DSNU-...	RoHS-compliant	
DSNU-...-S10/11	Contains paint-wetting impairment substances	
[6] Swivel bearing	Polymer	

Data sheet

Dimensions

Download CAD data → www.festo.com

DSNU-8 ... 25

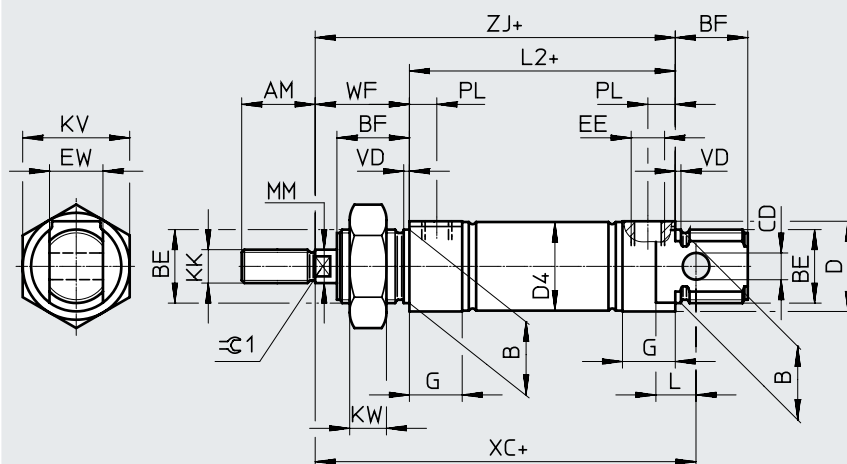

Note
 Piston rod nut is not included in the scope of delivery for diameter 8 ... 20.
 + = plus stroke length

∅ [mm]	AM	B ∅ h9	BE	BF	CD ∅ H9	D ∅	D4 ∅	EE	EW	G	KK	KV
8	12	12	M12x1.25	12	4	15	9.3	M5	8	10	M4	19
10	16	16	M16x1.5	17	6	20	11.3					
12							13.3					
16							17.3					
20	20	22	M22x1.5	20	8	27	21.3	G1/8	16	16	M8	32
25	22			22								

∅ [mm]	KW	L	L2	MM ∅	PL	VD	WF	XC ±1	ZJ	≈G1
8	6	6	46	4	6	2	16	64	62	-
10	8	9	50	6	8.2		22	75	72	5
12			56						78	
16			68	82						
20	11	12	68	8			24	95	92	7
25			69.5	10			28	104	97.5	9

Data sheet

Dimensions

Download CAD data → www.festo.com

DSNU-8 ... 25

MQ – Lateral supply port, short end cap

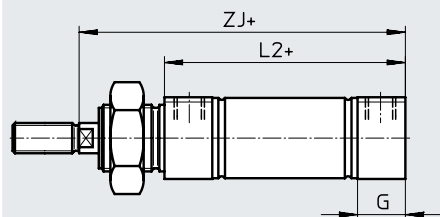

MA – Axial supply port, short end cap

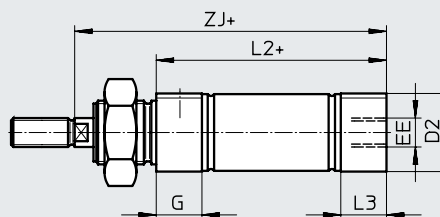

MH – With direct mounting

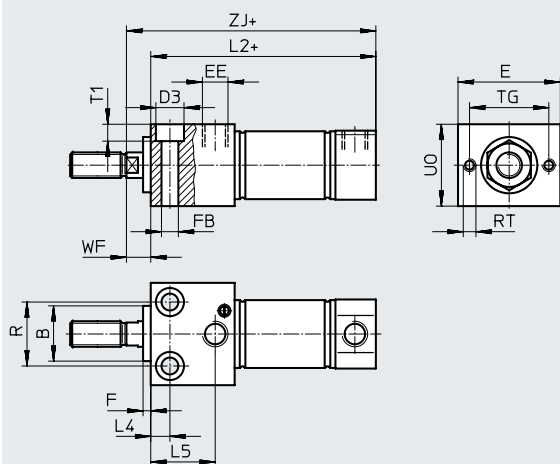

+ = plus stroke length

∅ [mm]	B ∅ h9	D2 ∅	D3 ∅	E	EE	F	FB ∅	G	L2		
									DSNU-...		
									-MQ	-MA	-MH
8	12	10.5	6	24	M5	3	3.4	10	46	43.6	53.5
10		12.5							43.1	53.8	
12		14.5							8	30	4.5
16	16	17.5	10	40	G1/8	5.5	16	56	53.7	67.5	
20		21.7						68	66.5	81.5	
25		26.7						11	69.5	68.5	86.2

∅ [mm]	L3	L4	L5	R	RT	TG	T1	UO	WF	ZJ								
										DSNU-...								
										-MQ	-MA	-MH						
8	7.6	5	14	12	M3	18	3.4	16	8	62	59.6	61.5						
10	7.1			16	M4	23	4.5	22	10	72	59.1	61.8						
12	7.7			18.1	31	4.5	22	10	78	69.7	72	75.7	77.8					
16	14.5	7.5	22.4	22	M5	31	5.5	28	11	92	90.5	91.5						
20										14	25.2	25	6.6	32	11	97.5	96.5	97.2
25										14	25.2	25	6.6	32	11	97.5	96.5	97.2

Data sheet

Dimensions

Download CAD data → www.festo.com

DSNU-8 ... 25

S2 – Through piston rod

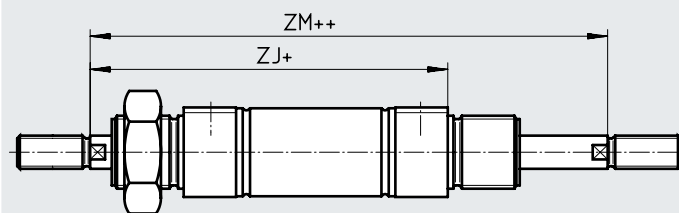

Note

The thread types at both piston rod ends are identical. In combination with variant Q, the left piston rod end is square, the right piston rod end round.

+ = plus stroke length
++ = plus 2x stroke length

K2 – Extended male piston rod thread

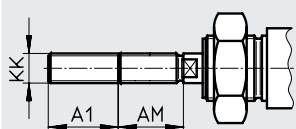

K6 – Shortened male piston rod thread

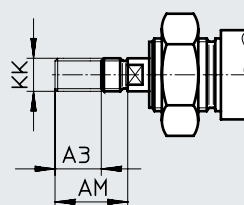

K3 – Female piston rod thread

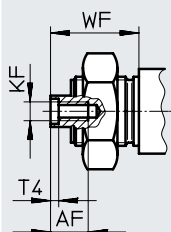

K5 – Custom piston rod thread

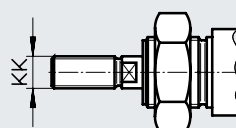

K8 – Extended piston rod

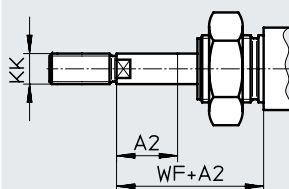

Note

If variant K8 is required in combination with S2, the piston rod will only be extended at one end.

ø [mm]	A1 max.	A2 max.	A3 max.	AF	AM	KF	KK		T4	WF	ZJ			ZM
							Basic thread	Custom thread ¹⁾			DSNU-...			
											-MQ	-MA	-MH	
8	15	50	4	-	12	-	M4	-	16	62	59.6	61.5	78.4	
10				-		-		59.1			61.8			
12	20	100		-	16	-	M6	-	22	72	69.7	72	94	
16				-		-		78			75.7	77.8		100
20	25	110	8	12	20	M4	M8	-	2	24	92	90.5	91.5	116
25	35	150			22	M6	M10x1.25	M10	2.6	28	97.5	96.5	97.2	125.5

1) The custom threads are only available as male threads. The scope of delivery does not include a hex nut for the piston rod thread

Data sheet

Dimensions

Download CAD data → www.festo.com

DSNU-32 ... 63

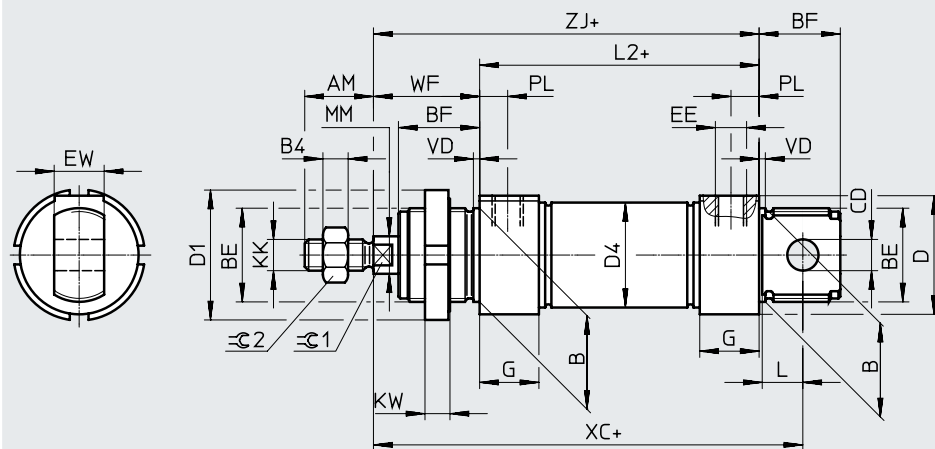

+ = plus stroke length

∅	AM	B ∅ h9	B4	BE	BF	CD ∅ E10	D ∅	D1 ∅	D4 ∅	EE	EW	G
32	22	30	5	M30x1.5	26	10	38	42	33.6	G1/8	16	19
40	24	38	6	M38x1.5	30	12	46	50	41.6	G1/4	18	25
50	32	45	8	M45x1.5	33	16	57	60	52.4	G3/8	21	28
63							70					

∅	KK	KW	L	L2	MM ∅	PL	VD	WF	XC ±1	ZJ	≅C1	≅C2
32	M10x1.25	8	13	69.5	12	9	2	34	117.5	103.5	10	16
40	M12x1.25	10	15	84.6	16	12	3	39	139.6	123.6	13	18
50	M16x1.5		16	86.2	20	13		44	147.2	130.2	17	24
63			94.2	13	45	156.2		139.2				

Data sheet

Dimensions

Download CAD data → www.festo.com

DSNU-32 ... 63

MQ – Lateral supply port, short end cap

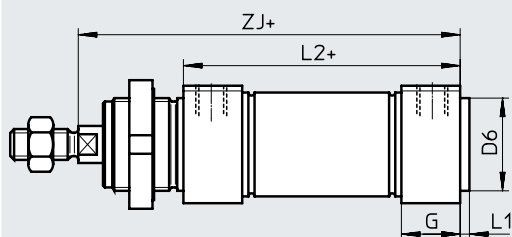

MA – Axial supply port, short end cap

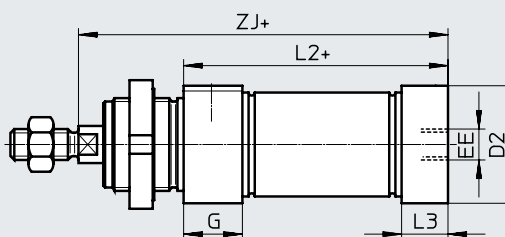

MH – With direct mounting

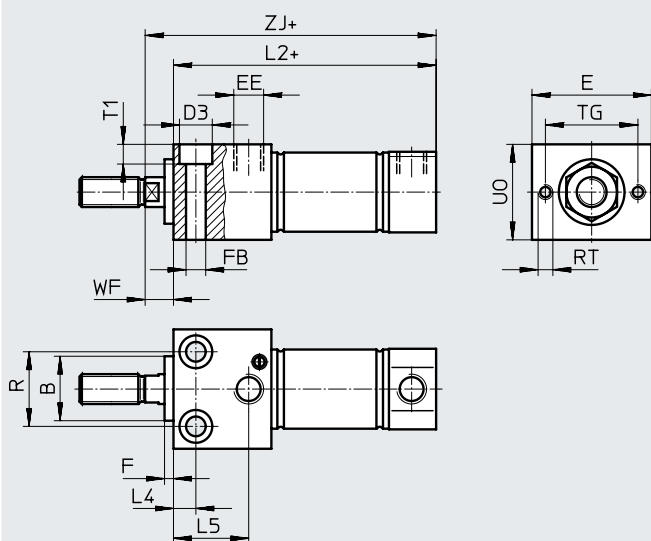

[1] Centring holes
(2 centring sleeves included in the scope of delivery)
+ = plus stroke length

∅ [mm]	B ∅ h9	B2	E	EE	G	F	FB ∅	D2 ∅	D3	D5 ∅	D6 ∅	L1	L2		
													DSNU-...		
													-MQ	-MA	-MH
32	30	1	48	G1/8	19	4	6.6	34	11	9	30	3	69.5	65.5	85.5
40	38		54	G1/4	25		9	42	14	12	38		4	84.6	77.6
50	45	2	64	G3/8	28	4	11	53	18	15	45	3	86.2	86.2	109.2
63			72					66					18	15	45

∅ [mm]	L3	L4	L5	R	RT	T0	T1	T2	TG	U0	WF	ZJ		
												DSNU-...		
												-MQ	-MA	-MH
32	15	12	25	30	M5	19	6.6	2.1	38	40	12	103.5	99.5	97.5
40	18	15	32	38	M6	24	9	2.6	42	48		12	123.6	116.5
50	25		35	42		32	32	9	2.6	50	58	15	130.2	130.2
63	28	15	36	44	M8	36	11	3.1	52	72	15	139.2	139.2	132.2

Data sheet

Dimensions

Download CAD data → www.festo.com

DSNU-32 ... 63
S2 – Through piston rod

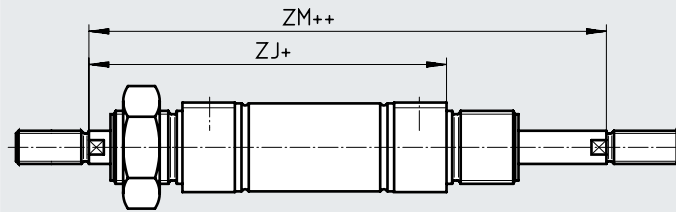

Note

The thread types at both piston rod ends are identical. In combination with variant Q, the left piston rod end is square, the right piston rod end round.

+ = plus stroke length
++ = plus 2x stroke length

K2 – Extended male piston rod thread

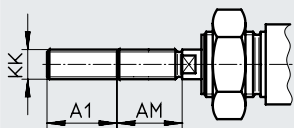

K6 – Shortened male piston rod thread

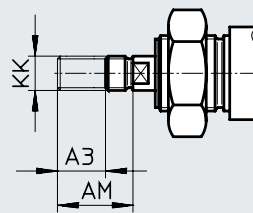

K3 – Female piston rod thread

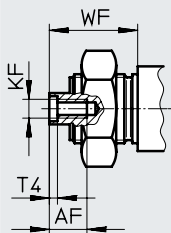

K5 – Custom piston rod thread

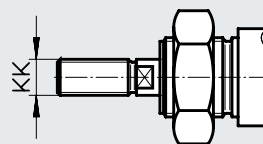

K8 – Extended piston rod

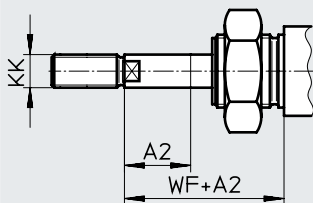

Note

If variant K8 is required in combination with S2, the piston rod will only be extended at one end.

ø [mm]	A1 max.	A2 max.	A3 max.	AF	AM	KF	KK		T4	WF	ZJ			ZM
							Basic thread	Custom thread ¹⁾			DSNU-...			
											-MQ	-MA	-MH	
32	35	500	8	12	22	M6	M10x1.25	M10	2.6	34	103.5	99.5	97.5	137.5
40					24	M8	M12x1.25	M12	3.3	39	123.6	111.6	116.6	162.6
50	70		10	16	32	M10	M16x1.5	M16	4.7	44	130.2	130.2	124.2	174.2
63										45	139.2	139.2	132.2	184.2

1) The custom threads are only available as male threads. The scope of delivery does not include a hex nut for the piston rod thread

Data sheet

★ Core product range

Ordering data				PPV – Pneumatic cushioning, adjustable at both ends		PPS – Pneumatic cushioning, self-adjusting at both ends	
Piston ø	Stroke	P – Elastic cushioning rings/plates at both ends	A – With position sensing	A – With position sensing		A – With position sensing	
[mm]	[mm]	Part no.	Type	Part no.	Type	Part no.	Type
12	10	★ 19189	DSNU-12-10-P-A	–		–	
	15	★ 1908255	DSNU-12-15-P-A	–		–	
	20	★ 1908256	DSNU-12-20-P-A	–		–	
	25	★ 19190	DSNU-12-25-P-A	–		–	
	30	★ 1908257	DSNU-12-30-P-A	–		–	
	40	★ 19191	DSNU-12-40-P-A	–		–	
	50	★ 19192	DSNU-12-50-P-A	–		–	
	60	★ 1908258	DSNU-12-60-P-A	–		–	
	80	★ 19193	DSNU-12-80-P-A	–		–	
	100	★ 19194	DSNU-12-100-P-A	–		–	
	125	★ 19195	DSNU-12-125-P-A	–		–	
	160	★ 19196	DSNU-12-160-P-A	–		–	
	200	★ 19197	DSNU-12-200-P-A	–		–	
16	10	★ 19198	DSNU-16-10-P-A	★ 1908266	DSNU-16-10-PPV-A	★ 1908274	DSNU-16-10-PPS-A
	15	★ 1908259	DSNU-16-15-P-A	★ 1908267	DSNU-16-15-PPV-A	★ 1908275	DSNU-16-15-PPS-A
	20	★ 1908260	DSNU-16-20-P-A	★ 1908268	DSNU-16-20-PPV-A	★ 1908276	DSNU-16-20-PPS-A
	25	★ 19199	DSNU-16-25-P-A	★ 33973	DSNU-16-25-PPV-A	★ 559263	DSNU-16-25-PPS-A
	30	★ 1908261	DSNU-16-30-P-A	★ 1908269	DSNU-16-30-PPV-A	★ 1908277	DSNU-16-30-PPS-A
	35	★ 1908262	DSNU-16-35-P-A	★ 1908270	DSNU-16-35-PPV-A	★ 1908278	DSNU-16-35-PPS-A
	40	★ 19200	DSNU-16-40-P-A	★ 19229	DSNU-16-40-PPV-A	★ 559264	DSNU-16-40-PPS-A
	50	★ 19201	DSNU-16-50-P-A	★ 19230	DSNU-16-50-PPV-A	★ 559265	DSNU-16-50-PPS-A
	60	★ 1908263	DSNU-16-60-P-A	★ 1908271	DSNU-16-60-PPV-A	★ 1908279	DSNU-16-60-PPS-A
	70	★ 1908264	DSNU-16-70-P-A	★ 1908272	DSNU-16-70-PPV-A	★ 1908280	DSNU-16-70-PPS-A
	80	★ 19202	DSNU-16-80-P-A	★ 19231	DSNU-16-80-PPV-A	★ 559266	DSNU-16-80-PPS-A
	100	★ 19203	DSNU-16-100-P-A	★ 19232	DSNU-16-100-PPV-A	★ 559267	DSNU-16-100-PPS-A
	125	★ 19204	DSNU-16-125-P-A	★ 19233	DSNU-16-125-PPV-A	★ 559268	DSNU-16-125-PPS-A
	150	★ 1908265	DSNU-16-150-P-A	★ 1908273	DSNU-16-150-PPV-A	★ 1908281	DSNU-16-150-PPS-A
	160	★ 19205	DSNU-16-160-P-A	★ 19234	DSNU-16-160-PPV-A	★ 559269	DSNU-16-160-PPS-A
	200	★ 19206	DSNU-16-200-P-A	★ 19235	DSNU-16-200-PPV-A	★ 559270	DSNU-16-200-PPS-A

Data sheet

★ Core product range

Ordering data				PPV – Pneumatic cushioning, adjustable at both ends		PPS – Pneumatic cushioning, self-adjusting at both ends	
Piston ø	Stroke	P – Elastic cushioning rings/plates at both ends	A – With position sensing	A – With position sensing		A – With position sensing	
[mm]	[mm]	Part no.	Type	Part no.	Type	Part no.	Type
20	10	★ 19207	DSNU-20-10-P-A	★ 1908289	DSNU-20-10-PPV-A	★ 1908297	DSNU-20-10-PPS-A
	15	★ 1908282	DSNU-20-15-P-A	★ 1908290	DSNU-20-15-PPV-A	★ 1908298	DSNU-20-15-PPS-A
	20	★ 1908283	DSNU-20-20-P-A	★ 1908291	DSNU-20-20-PPV-A	★ 1908299	DSNU-20-20-PPS-A
	25	★ 19208	DSNU-20-25-P-A	★ 33974	DSNU-20-25-PPV-A	★ 559271	DSNU-20-25-PPS-A
	30	★ 1908284	DSNU-20-30-P-A	★ 1908292	DSNU-20-30-PPV-A	★ 1908300	DSNU-20-30-PPS-A
	35	★ 1908285	DSNU-20-35-P-A	★ 1908293	DSNU-20-35-PPV-A	★ 1908301	DSNU-20-35-PPS-A
	40	★ 19209	DSNU-20-40-P-A	★ 19236	DSNU-20-40-PPV-A	★ 559272	DSNU-20-40-PPS-A
	50	★ 19210	DSNU-20-50-P-A	★ 19237	DSNU-20-50-PPV-A	★ 559273	DSNU-20-50-PPS-A
	60	★ 1908286	DSNU-20-60-P-A	★ 1908294	DSNU-20-60-PPV-A	★ 1908302	DSNU-20-60-PPS-A
	70	★ 1908287	DSNU-20-70-P-A	★ 1908295	DSNU-20-70-PPV-A	★ 1908303	DSNU-20-70-PPS-A
	80	★ 19211	DSNU-20-80-P-A	★ 19238	DSNU-20-80-PPV-A	★ 559274	DSNU-20-80-PPS-A
	100	★ 19212	DSNU-20-100-P-A	★ 19239	DSNU-20-100-PPV-A	★ 559275	DSNU-20-100-PPS-A
	125	★ 19213	DSNU-20-125-P-A	★ 19240	DSNU-20-125-PPV-A	★ 559276	DSNU-20-125-PPS-A
	150	★ 1908288	DSNU-20-150-P-A	★ 1908296	DSNU-20-150-PPV-A	★ 1908304	DSNU-20-150-PPS-A
	160	★ 19214	DSNU-20-160-P-A	★ 19241	DSNU-20-160-PPV-A	★ 559277	DSNU-20-160-PPS-A
	200	★ 19215	DSNU-20-200-P-A	★ 19242	DSNU-20-200-PPV-A	★ 559278	DSNU-20-200-PPS-A
	250	★ 19216	DSNU-20-250-P-A	★ 19243	DSNU-20-250-PPV-A	★ 559279	DSNU-20-250-PPS-A
	300	★ 19217	DSNU-20-300-P-A	★ 19244	DSNU-20-300-PPV-A	★ 559280	DSNU-20-300-PPS-A
320	★ 34718	DSNU-20-320-P-A	★ 34720	DSNU-20-320-PPV-A	★ 559281	DSNU-20-320-PPS-A	
25	10	★ 19218	DSNU-25-10-P-A	★ 1908312	DSNU-25-10-PPV-A	★ 1908320	DSNU-25-10-PPS-A
	15	★ 1908305	DSNU-25-15-P-A	★ 1908313	DSNU-25-15-PPV-A	★ 1908321	DSNU-25-15-PPS-A
	20	★ 1908306	DSNU-25-20-P-A	★ 1908314	DSNU-25-20-PPV-A	★ 1908322	DSNU-25-20-PPS-A
	25	★ 19219	DSNU-25-25-P-A	★ 33975	DSNU-25-25-PPV-A	★ 559282	DSNU-25-25-PPS-A
	30	★ 1908307	DSNU-25-30-P-A	★ 1908315	DSNU-25-30-PPV-A	★ 1908323	DSNU-25-30-PPS-A
	35	★ 1908308	DSNU-25-35-P-A	★ 1908316	DSNU-25-35-PPV-A	★ 1908324	DSNU-25-35-PPS-A
	40	★ 19220	DSNU-25-40-P-A	★ 19245	DSNU-25-40-PPV-A	★ 559283	DSNU-25-40-PPS-A
	50	★ 19221	DSNU-25-50-P-A	★ 19246	DSNU-25-50-PPV-A	★ 559284	DSNU-25-50-PPS-A
	60	★ 1908309	DSNU-25-60-P-A	★ 1908317	DSNU-25-60-PPV-A	★ 1908325	DSNU-25-60-PPS-A
	70	★ 1908310	DSNU-25-70-P-A	★ 1908318	DSNU-25-70-PPV-A	★ 1908326	DSNU-25-70-PPS-A
	80	★ 19222	DSNU-25-80-P-A	★ 19247	DSNU-25-80-PPV-A	★ 559285	DSNU-25-80-PPS-A
	100	★ 19223	DSNU-25-100-P-A	★ 19248	DSNU-25-100-PPV-A	★ 559286	DSNU-25-100-PPS-A
	125	★ 19224	DSNU-25-125-P-A	★ 19249	DSNU-25-125-PPV-A	★ 559287	DSNU-25-125-PPS-A
	150	★ 1908311	DSNU-25-150-P-A	★ 1908319	DSNU-25-150-PPV-A	★ 1908327	DSNU-25-150-PPS-A
	160	★ 19225	DSNU-25-160-P-A	★ 19250	DSNU-25-160-PPV-A	★ 559288	DSNU-25-160-PPS-A
	200	★ 19226	DSNU-25-200-P-A	★ 19251	DSNU-25-200-PPV-A	★ 559289	DSNU-25-200-PPS-A
	250	★ 19227	DSNU-25-250-P-A	★ 19252	DSNU-25-250-PPV-A	★ 559290	DSNU-25-250-PPS-A
	300	★ 19228	DSNU-25-300-P-A	★ 19253	DSNU-25-300-PPV-A	★ 559291	DSNU-25-300-PPS-A
320	★ 34719	DSNU-25-320-P-A	★ 34721	DSNU-25-320-PPV-A	★ 559292	DSNU-25-320-PPS-A	

Data sheet

Ordering data							
Piston \varnothing [mm]	Stroke [mm]	P – Elastic cushioning rings/plates at both ends		PPV – Pneumatic cushioning, adjustable at both ends		PPS – Pneumatic cushioning, self-adjusting at both ends	
		A – With position sensing		A – With position sensing		A – With position sensing	
		Part no.	Type	Part no.	Type	Part no.	Type
8	10	19177	DSNU-8-10-P-A	–		–	
	15	1908247	DSNU-8-15-P-A				
	20	1908248	DSNU-8-20-P-A				
	25	19178	DSNU-8-25-P-A				
	30	1908249	DSNU-8-30-P-A				
	40	19179	DSNU-8-40-P-A				
	50	19180	DSNU-8-50-P-A				
	60	1908250	DSNU-8-60-P-A				
	80	19181	DSNU-8-80-P-A				
100	19182	DSNU-8-100-P-A					
10	10	19183	DSNU-10-10-P-A	–		–	
	15	1908251	DSNU-10-15-P-A				
	20	1908252	DSNU-10-20-P-A				
	25	19184	DSNU-10-25-P-A				
	30	1908253	DSNU-10-30-P-A				
	40	19185	DSNU-10-40-P-A				
	50	19186	DSNU-10-50-P-A				
	60	1908254	DSNU-10-60-P-A				
	80	19187	DSNU-10-80-P-A				
100	19188	DSNU-10-100-P-A					
25	400	35191	DSNU-25-400-P-A	35193	DSNU-25-400-PPV-A	559293	DSNU-25-400-PPS-A
	500	35192	DSNU-25-500-P-A	35194	DSNU-25-500-PPV-A	559294	DSNU-25-500-PPS-A
32	25	195980	DSNU-32-25-P-A	196020	DSNU-32-25-PPV-A	559295	DSNU-32-25-PPS-A
	40	195981	DSNU-32-40-P-A	196021	DSNU-32-40-PPV-A	559296	DSNU-32-40-PPS-A
	50	195982	DSNU-32-50-P-A	196022	DSNU-32-50-PPV-A	559297	DSNU-32-50-PPS-A
	80	195983	DSNU-32-80-P-A	196023	DSNU-32-80-PPV-A	559298	DSNU-32-80-PPS-A
	100	195984	DSNU-32-100-P-A	196024	DSNU-32-100-PPV-A	559299	DSNU-32-100-PPS-A
	125	195985	DSNU-32-125-P-A	196025	DSNU-32-125-PPV-A	559300	DSNU-32-125-PPS-A
	160	195986	DSNU-32-160-P-A	196026	DSNU-32-160-PPV-A	559301	DSNU-32-160-PPS-A
	200	195987	DSNU-32-200-P-A	196027	DSNU-32-200-PPV-A	559302	DSNU-32-200-PPS-A
	250	195988	DSNU-32-250-P-A	196028	DSNU-32-250-PPV-A	559303	DSNU-32-250-PPS-A
	320	195989	DSNU-32-320-P-A	196029	DSNU-32-320-PPV-A	559304	DSNU-32-320-PPS-A

Data sheet

Ordering data							
Piston ø [mm]	Stroke [mm]	P – Elastic cushioning rings/plates at both ends		PPV – Pneumatic cushioning, adjustable at both ends		PPS – Pneumatic cushioning, self-adjusting at both ends	
		A – With position sensing		A – With position sensing		A – With position sensing	
		Part no.	Type	Part no.	Type	Part no.	Type
40	25	195990	DSNU-40-25-P-A	196030	DSNU-40-25-PPV-A	559305	DSNU-40-25-PPS-A
	40	195991	DSNU-40-40-P-A	196031	DSNU-40-40-PPV-A	559306	DSNU-40-40-PPS-A
	50	195992	DSNU-40-50-P-A	196032	DSNU-40-50-PPV-A	559307	DSNU-40-50-PPS-A
	80	195993	DSNU-40-80-P-A	196033	DSNU-40-80-PPV-A	559308	DSNU-40-80-PPS-A
	100	195994	DSNU-40-100-P-A	196034	DSNU-40-100-PPV-A	559309	DSNU-40-100-PPS-A
	125	195995	DSNU-40-125-P-A	196035	DSNU-40-125-PPV-A	559310	DSNU-40-125-PPS-A
	160	195996	DSNU-40-160-P-A	196036	DSNU-40-160-PPV-A	559311	DSNU-40-160-PPS-A
	200	195997	DSNU-40-200-P-A	196037	DSNU-40-200-PPV-A	559312	DSNU-40-200-PPS-A
	250	195998	DSNU-40-250-P-A	196038	DSNU-40-250-PPV-A	559313	DSNU-40-250-PPS-A
320	195999	DSNU-40-320-P-A	196039	DSNU-40-320-PPV-A	559314	DSNU-40-320-PPS-A	
50	25	196000	DSNU-50-25-P-A	196040	DSNU-50-25-PPV-A	559315	DSNU-50-25-PPS-A
	40	196001	DSNU-50-40-P-A	196041	DSNU-50-40-PPV-A	559316	DSNU-50-40-PPS-A
	50	196002	DSNU-50-50-P-A	196042	DSNU-50-50-PPV-A	559317	DSNU-50-50-PPS-A
	80	196003	DSNU-50-80-P-A	196043	DSNU-50-80-PPV-A	559318	DSNU-50-80-PPS-A
	100	196004	DSNU-50-100-P-A	196044	DSNU-50-100-PPV-A	559319	DSNU-50-100-PPS-A
	125	196005	DSNU-50-125-P-A	196045	DSNU-50-125-PPV-A	559320	DSNU-50-125-PPS-A
	160	196006	DSNU-50-160-P-A	196046	DSNU-50-160-PPV-A	559321	DSNU-50-160-PPS-A
	200	196007	DSNU-50-200-P-A	196047	DSNU-50-200-PPV-A	559322	DSNU-50-200-PPS-A
	250	196008	DSNU-50-250-P-A	196048	DSNU-50-250-PPV-A	559323	DSNU-50-250-PPS-A
320	196009	DSNU-50-320-P-A	196049	DSNU-50-320-PPV-A	559324	DSNU-50-320-PPS-A	
63	25	196010	DSNU-63-25-P-A	196050	DSNU-63-25-PPV-A	559325	DSNU-63-25-PPS-A
	40	196011	DSNU-63-40-P-A	196051	DSNU-63-40-PPV-A	559326	DSNU-63-40-PPS-A
	50	196012	DSNU-63-50-P-A	196052	DSNU-63-50-PPV-A	559327	DSNU-63-50-PPS-A
	80	196013	DSNU-63-80-P-A	196053	DSNU-63-80-PPV-A	559328	DSNU-63-80-PPS-A
	100	196014	DSNU-63-100-P-A	196054	DSNU-63-100-PPV-A	559329	DSNU-63-100-PPS-A
	125	196015	DSNU-63-125-P-A	196055	DSNU-63-125-PPV-A	559330	DSNU-63-125-PPS-A
	160	196016	DSNU-63-160-P-A	196056	DSNU-63-160-PPV-A	559331	DSNU-63-160-PPS-A
	200	196017	DSNU-63-200-P-A	196057	DSNU-63-200-PPV-A	559332	DSNU-63-200-PPS-A
	250	196018	DSNU-63-250-P-A	196058	DSNU-63-250-PPV-A	559333	DSNU-63-250-PPS-A
320	196019	DSNU-63-320-P-A	196059	DSNU-63-320-PPV-A	559334	DSNU-63-320-PPS-A	

Data sheet

Ordering data					
Piston \varnothing	Stroke	P – Elastic cushioning rings/plates at both ends		PPV – Pneumatic cushioning, adjustable at both ends	
[mm]	[mm]	A – With position sensing		A – With position sensing	
		Part no.	Type	Part no.	Type
Variable stroke					
8	10 ... 100	14326	DSNU-8-...-P-A		
10	10 ... 100	14325	DSNU-10-...-P-A		
12	10 ... 200	14324	DSNU-12-...-P-A		
16	10 ... 200	14323	DSNU-16-...-P-A		
20	10 ... 320	14328	DSNU-20-...-P-A		
25	10 ... 500	14327	DSNU-25-...-P-A		
Variable stroke					
		14320	DSNU-16-...-PPV-A		
		14321	DSNU-20-...-PPV-A		
		14322	DSNU-25-...-PPV-A		

Ordering data – Modular product system

Ordering table										
Size	8	10	12	16	20	25	Conditions	Code	Enter code	
Module no.	193986	193987	193988	193989	193990	193991				
Function	Round cylinder, double-acting, based on ISO 6432								DSNU	DSNU
Piston ø [mm]	8	10	12	16	20	25		★ -...		
Stroke [mm]	1 ... 100		1 ... 200		1 ... 320	1 ... 500	[1]	★ -...		
Cushioning	Elastic cushioning rings/plates at both ends								★ -P	
	-	-	Pneumatic cushioning, adjustable at both ends				[2]	★ -PPV		
	-	-	-	Pneumatic cushioning, self-adjusting at both ends				[3]	★ -PPS	
Position sensing	Via proximity switch							[4]	★ -A	
Cylinder end cap	Lateral supply port, short end cap							[5]	★ -MQ	
	Axial supply port, short end cap							[5]	-MA	
	With mounting flange at front (direct mounting), bearing cap							[6]	-MH	
Piston rod type	Through piston rod							[7]	★ -S2	

- [1] -... Longer strokes on request
- [2] PPV Not with MA. In combination with S6, S10, S11 not with piston diameter 12 mm
- [3] PPS Not with MA, MH, S6, S10, S11 and not with combination MQ-R3
- [4] A Minimum stroke: 10 mm
- [5] MQ, MA Not with S2, S10, S11
- [6] MH Not with combination S6-R3. Not with S10, S11
- [7] S2 Not with S10, S11



Note

The bellows kit DADB must not be used in combination with the variant MH.

The running characteristics change slightly when the bellows kit DADB is combined with the variant S10 or S11

Ordering data – Modular product system

Ordering table		8	10	12	16	20	25	Conditions	Code	Enter code	
Extended male thread		Extended male piston rod thread									
	[mm]	1 ... 15	1 ... 20	1 ... 25	1 ... 35	[8]			-...K2		
Shortened male thread		Shortened male piston rod thread									
	[mm]	1 ... 4		1 ... 8	1 ... 10	[9]			-...K6		
Female thread		Piston rod with female thread									
		-	-	-	-	(M4)	(M6)	[10]	★ -K3		
Custom thread		Custom piston rod thread									
		-	-	-	-	-	M10		-“...”K5		
Extended piston rod at one end		Extended piston rod at one end									
	[mm]	1 ... 50	1 ... 100	1 ... 110	1 ... 150				★ ...K8		
Temperature resistance		Heat-resistant seals max. 120°C					[11]		★ -S6		
Constant motion		-	-	Slow speed (constant motion at low piston speeds)			[12]		-S10		
Low friction		-	-	Low friction			[13]		-S11		
Corrosion protection		-	-	High corrosion protection					★ -R3		
EU certification		II 2GD					[14]		-EX4		

[8]	K2	Not with K3, K6
[9]	K6	Not with K3
[10]	K3	Not with K5
[11]	S6	Not with S10, S11
[12]	S10	Not with S11, R3
[13]	S11	Not with R3
[14]	EX4	Not with S6

Ordering data – Modular product system

Ordering table							
Size	32	40	50	63	Conditions	Code	Enter code
Module no.	193992	193993	193994	193995			
Function	Double-acting round cylinder					DSNU	DSNU
Piston ø [mm]	32	40	50	63		★ -...	
Stroke [mm]	1 ... 500				[1]	★ -...	
Cushioning	Elastic cushioning rings/plates at both ends					★ -P	
	Pneumatic cushioning, adjustable at both ends				[2]	★ -PPV	
	Pneumatic cushioning, self-adjusting at both ends				[3]	★ -PPS	
Position sensing	Via proximity switch				[4]	★ -A	
Cylinder end cap	Lateral supply port, short end cap				[5]	★ -MQ	
	Axial supply port, short end cap				[6]	-MA	
	Mounting flange at front (direct mounting), bearing cap				[7]	-MH	
Piston rod type	Through piston rod				[8]	★ -S2	

- [1] -... Longer strokes on request
- [2] PPV Not with MA
- [3] PPS Not with MA, MH, S6, S10, S11 and not with combination MQ-R3 and R8
- [4] A Minimum stroke: 10 mm
- [5] MQ Not with S2, S10, S11
- [6] MA Not with S2, S10, S11, R8
- [7] MH Not with combination S6-R3. Not with S10, S11, R8
- [8] S2 Not with S10, S11

 **Note**

The bellows kit DADB must not be used in combination with the variant MH.

The running characteristics change slightly when the bellows kit DADB is combined with the variant S10 or S11

Ordering data – Modular product system

Ordering table		32	40	50	63	Conditions	Code	Enter code
Extended male thread		Extended male piston rod thread						
	[mm]	1 ... 35		1 ... 70		[9]	-...K2	
Shortened male thread		Shortened male piston rod thread						
	[mm]	1 ... 8		1 ... 10		[10]	-...K6	
Female thread		Piston rod with female thread						
		(M6)	(M8)	(M10)		[11]	★ -K3	
Custom thread		Custom piston rod thread						
		M10	M12	M16			-“...”K5	
Extended piston rod at one end		Extended piston rod at one end						
	[mm]	1 ... 500					★ ...K8	
Temperature resistance		Heat-resistant seals max. 120°C				[12]	★ -S6	
Constant motion		Slow speed (constant motion at low piston speeds)				[13]	-S10	
Running characteristic		Low friction				[14]	-S11	
Corrosion protection		High corrosion protection				[15]	★ -R3	
Wiper seal		Dust protection					-R8	
		Metal scraper				[16]	-A6	
EU certification		II 2GD				[17]	-EX4	

[9]	K2	Not with K3, K6
[10]	K6	Not with K3
[11]	K3	Not with K5
[12]	S6	Not with S10, S1
[13]	S10	Not with S11, R3, R8
[14]	S11	Not with R3, R8
[15]	R3	Not with R8
[16]	A6	Not with S10, S11, MH, P, PPS, S6, R3, EX4
[17]	EX4	Not with S6, S10, S11

Data sheet

P cushioning

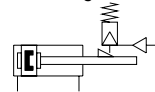

-  - Diameter
8 ... 25 mm
ISO 6432

PPV cushioning

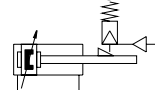

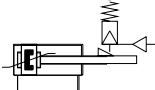

-  - Diameter
32 ... 63 mm

PPS cushioning

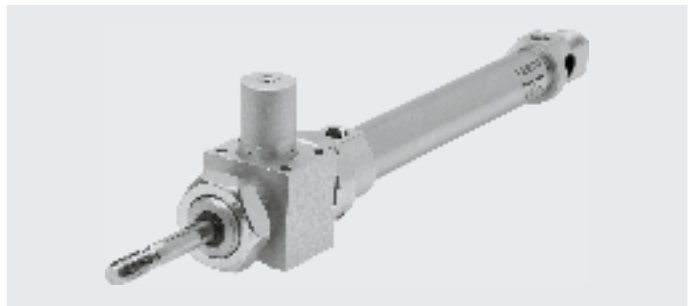

-  - Stroke length
1 ... 500 mm



 **Note**
If used in safety-relevant applications, additional measures are necessary, e.g. in Europe the standards listed in the EC Machinery Directive must be observed. Without additional measures in accordance with legally specified minimum requirements, the product is not suitable as a safety-related component in control systems.

General technical data											
Piston \varnothing	8	10	12	16	20	25	32	40	50	63	
Based on standard	ISO 6432						-				
Pneumatic connection	M5	M5	M5	M5	G1/8	G1/8	G1/8	G1/4	G1/4	G3/8	
Piston rod thread	M4	M4	M6	M6	M8	M10x1.25	M10x1.25	M12x1.25	M16x1.5	M16x1.5	
Stroke ¹⁾ [mm]	1 ... 100		1 ... 200		1 ... 320		1 ... 500				
Design	Piston/piston rod/cylinder barrel										
Cushioning											
DSNU...-P	Elastic cushioning rings/plates at both ends										
DSNU...-PPV	-		Cushioning, adjustable at both ends								
DSNU...-PPS	-		Cushioning, self-adjusting at both ends								
Cushioning length											
DSNU...-PPV [mm]	-		9	12	15	17	14	18	20	21	
DSNU...-PPS [mm]	-		12	15	17	14	18	20	21		
Position sensing	Via proximity switch										
Type of mounting	With through-hole										
	With accessories										
Mounting position	Any										
Holding force of the clamping unit [N]	80	80	180	180	350	350	600	1000	1400	2000	
Axial backlash under load [mm]	0.2			0.3		0.5		0.8			
Pneumatic connection on clamping unit	M5							G1/8			

1) Cylinders with position sensing require a minimum stroke of 10 mm to ensure reliable sensing.
Longer strokes on request

Data sheet

Operating and environmental conditions	
Operating medium	Compressed air to ISO 8573-1:2010 [7:4:4]
Note on the operating/ pilot medium	Lubricated operation possible (in which case lubricated operation will always be required)
Operating pressure [bar]	3 ... 10
Ambient temperature [°C]	-10 ... +80
Corrosion resistance class CRC ²⁾	
DSNU-...	2
DSNU...-R3	3

1) Note operating range of proximity switches

2) Corrosion resistance class CRC 2 to Festo standard FN 940070

Moderate corrosion stress. Indoor applications in which condensation can occur. External visible parts with primarily decorative surface requirements which are in direct contact with a normal industrial environment.

Corrosion resistance class CRC 3 to Festo standard FN 940070

High corrosion stress. Outdoor exposure under moderate corrosive conditions. Externally visible parts with primarily functional surface requirements which are in direct contact with a normal industrial environment.

Forces [N] and impact energy [J]										
Piston Ø	8	10	12	16	20	25	32	40	50	63
Theoretical force at 6 bar, advancing	30	47	68	121	189	295	483	753	1178	1870
Theoretical force at 6 bar, retracting	23	40	51	104	158	247	415	633	990	1682
Impact energy in the end positions for P cushioning ¹⁾	0.03	0.05	0.07	0.15	0.20	0.30	0.40	0.70	1	1.3

1) The values are reduced by approx. 50% at an ambient temperature of 80°C

Weight [g]										
Piston Ø	8	10	12	16	20	25	32	40	50	63
Product weight with 0 mm stroke	97.6	100.3	193	207.9	393.8	456	711.5	1287	2059	2556
Additional weight per 10 mm stroke	2.4	2.7	4	4.6	7.2	11	15.5	24	40	44
Moving mass with 0 mm stroke	7.5	8.5	18.5	23	44	71	121	230	413	459
Moving mass per 10 mm stroke	1	1	2	2	4	6	9	16	25	25

Data sheet

Average piston speed v as a function of payload m in combination with cushioning PPS

Piston $\varnothing 16$

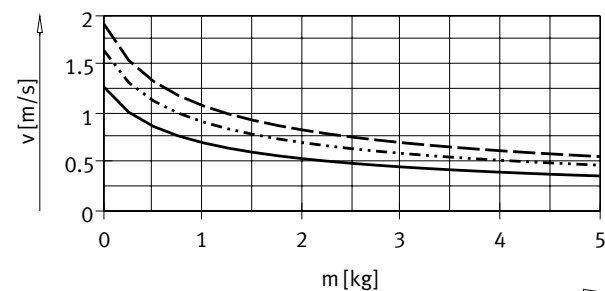

- DSNU-16-50
- ⋯ DSNU-16-100
- - - DSNU-16-200

Piston $\varnothing 20$

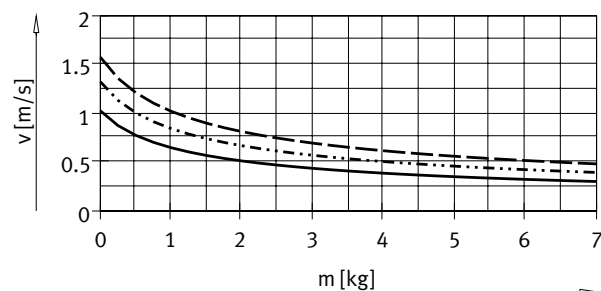

- DSNU-20-50
- ⋯ DSNU-20-100
- - - DSNU-20-200

Piston $\varnothing 25$

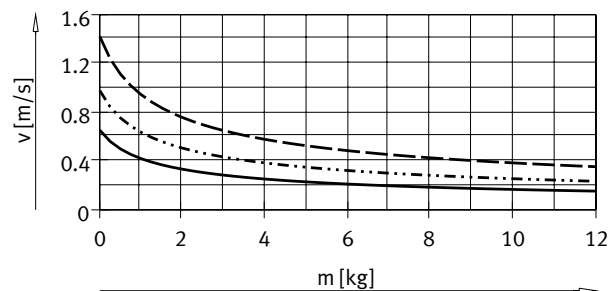

- DSNU-25-50
- ⋯ DSNU-25-100
- - - DSNU-25-200

Piston $\varnothing 32$

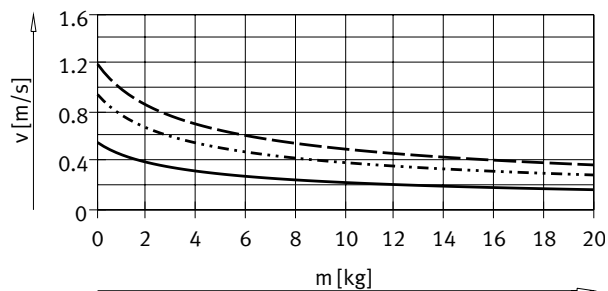

- DSNU-32-50
- ⋯ DSNU-32-100
- - - DSNU-32-200

Piston $\varnothing 40$

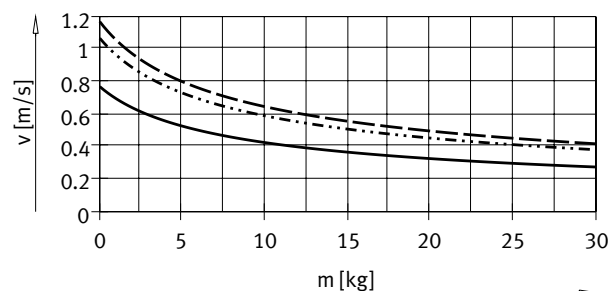

- DSNU-40-50
- ⋯ DSNU-40-100
- - - DSNU-40-200

Piston $\varnothing 50$

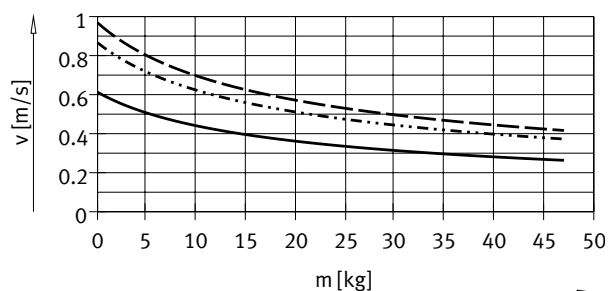

- DSNU-50-50
- ⋯ DSNU-50-100
- - - DSNU-50-200

Data sheet

Average piston speed v as a function of payload m in combination with cushioning PPS

Piston \varnothing 63

Note:

Average piston speed
= Stroke/movement time

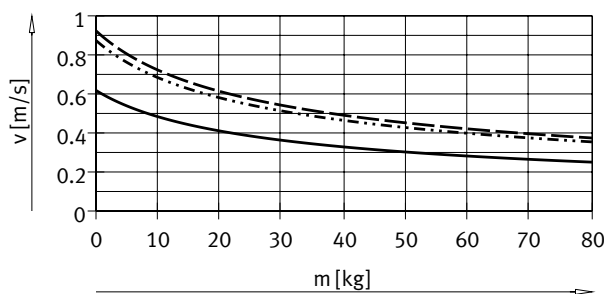

Engineering software for
P cushioning
PPV cushioning
→ https://www.festo.com/eap/en_gb/PneumaticSizing/

Additional graphs for
PPS cushioning
→ www.festo.com

- DSNU-63-50
- DSNU-63-100
- - - DSNU-63-200

Max. transverse load F_q as a function of projection l

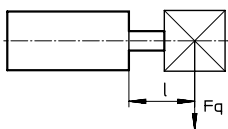

DSNU-...

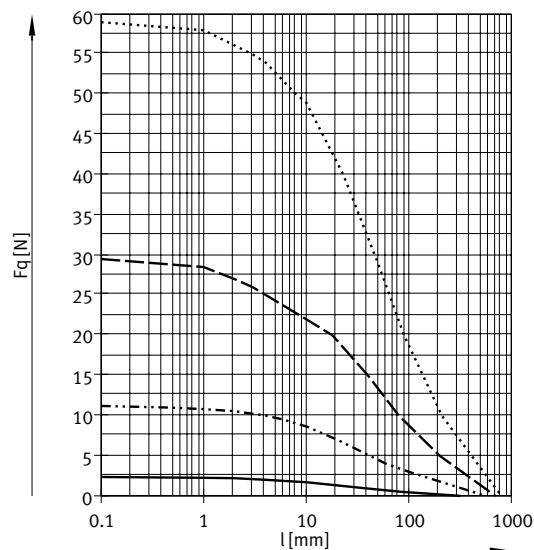

- DSNU-8/10
- DSNU-12/16
- - - DSNU-20
- · - · DSNU-25

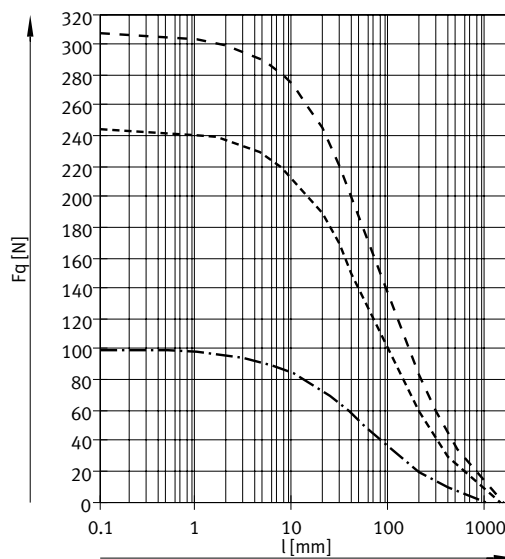

- DSNU-32
- - - DSNU-40
- · - · DSNU-50/63

Data sheet

Max. transverse load F_q as a function of projection l

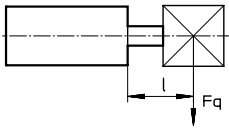

DSNU-...S2 – Through piston rod

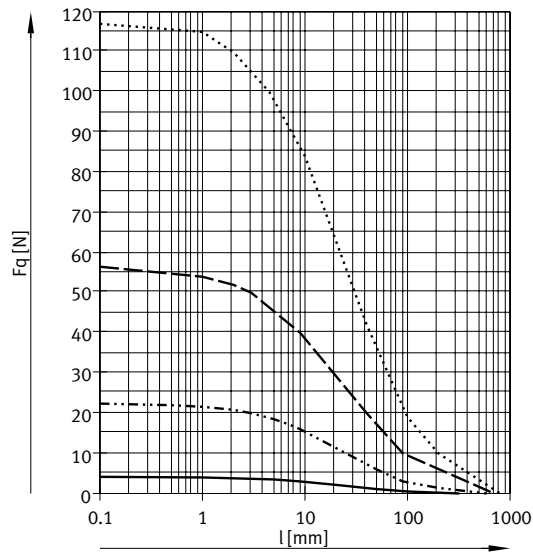

- DSNU-8/10
- - - - DSNU-12/16
- DSNU-20
- DSNU-25

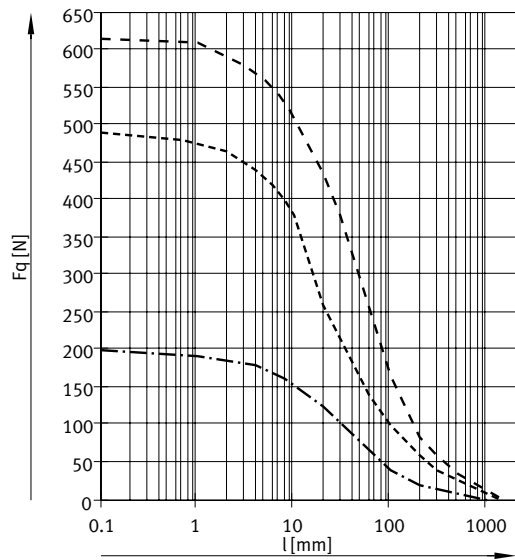

- · - · - DSNU-32
- - - - DSNU-40
- DSNU-50/63

Data sheet

Materials

Sectional view

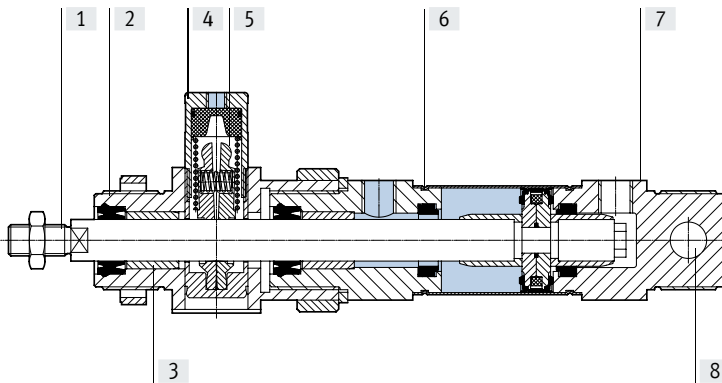

Round cylinder

[1]	Piston rod	
	DSNU-...	High-alloy steel
	DSNU-...-R3	High-alloy stainless steel
[2]	Bearing cap	Anodised aluminium
[3]	Piston rod bearing	Sintered bronze
[4]	Housing, clamping unit	Wrought aluminium alloy
[5]	Clamping jaw	Brass
[6]	Cylinder barrel	High-alloy stainless steel
[7]	End cap	Anodised aluminium
-	Piston, clamping unit	POM
-	Spring	Spring steel
-	Seals	TPE-U(PU), NBR
	Note on materials	RoHS-compliant
[8]	Swivel bearing	Polymer

Data sheet

Dimensions

Download CAD data → www.festo.com

DSNU-8 ... 25

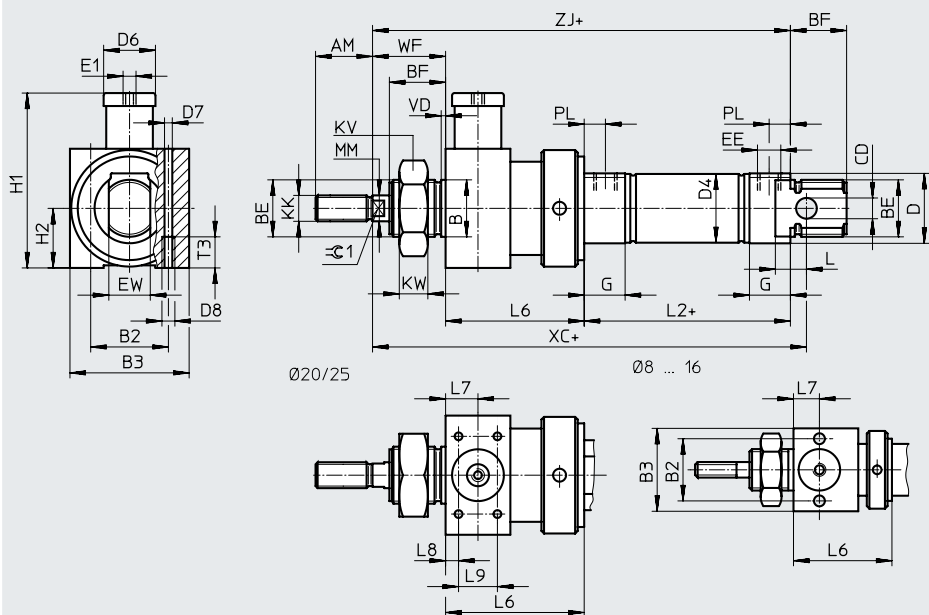

Note
 Piston rod nut is not included in the scope of delivery for diameter 8 ... 20.
 + = plus stroke length

∅ [mm]	AM	B ∅ h9	B2	B3	BE	BF	CD ∅ H9	D ∅	D4 ∅	D6 ∅	D7 ∅	D8
8	12	12	19.5	27	M12x1.25	12	4	15	9.3	12	4.2	M5
10	16	16	24	32	M16x1.5	17	6	20	11.3	16	4.2	M5
12									13.3			
16	20	22	27	36	M22x1.5	20	8	27	17.3	20	4.2	M5
20									21.3			
25	22					22			26.5			

∅ [mm]	E1	EE	EW	G	H1	H2	KK	KV	KW	MM ∅	L	L2
8	M5	M5	8	10	34.5	13.5	M4	19	6	4	6	46
10	M5	M5	12	10	41	16	M6	24	8	6	9	50
12												
16	G1/8	M5	16	16	62.5	18	M8	32	11	8	12	68
20												
25							M10x1.25			10		69.5

∅ [mm]	L6	L7	L8	L9	T3	PL	VD	WF	XC	≡C1
8	29 ±0.65	8	-	-	11	6	2	16	93	-
10	38 ±0.75	10	-	-				5		
12			13	4.5	20	8.2	22		113	
16	24	120								
20	47 ±0.75					24	142	7		
25	48 ±0.75					28	152	9		

Data sheet

Dimensions

Download CAD data → www.festo.com

DSNU-8 ... 25

S2 – Through piston rod

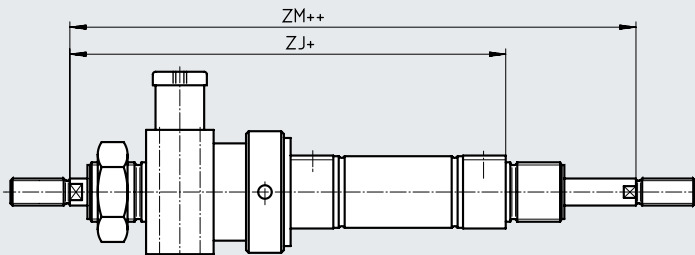

+ = plus stroke length
++ = plus 2x stroke length

 **Note**

The thread types at both piston rod ends are identical. The clamping unit is mounted at only one end.

In combination with variant Q (→ page 46) the right piston rod is square, the left piston rod round. The clamping unit is mounted on the left-hand, round piston rod.

In combination with variant K8, the piston rod is only extended at the right piston rod. The clamping unit is mounted on the left piston rod that is not extended.

In combination with variant K8 and Q, the piston rod is only extended at the right, square piston rod.

∅ [mm]	ZJ	ZM
8	91	107
10		
12	110	132
16	116	138
20	139	163
25	145.5	173.5

Data sheet

Dimensions

Download CAD data → www.festo.com

DSNU-8 ... 25

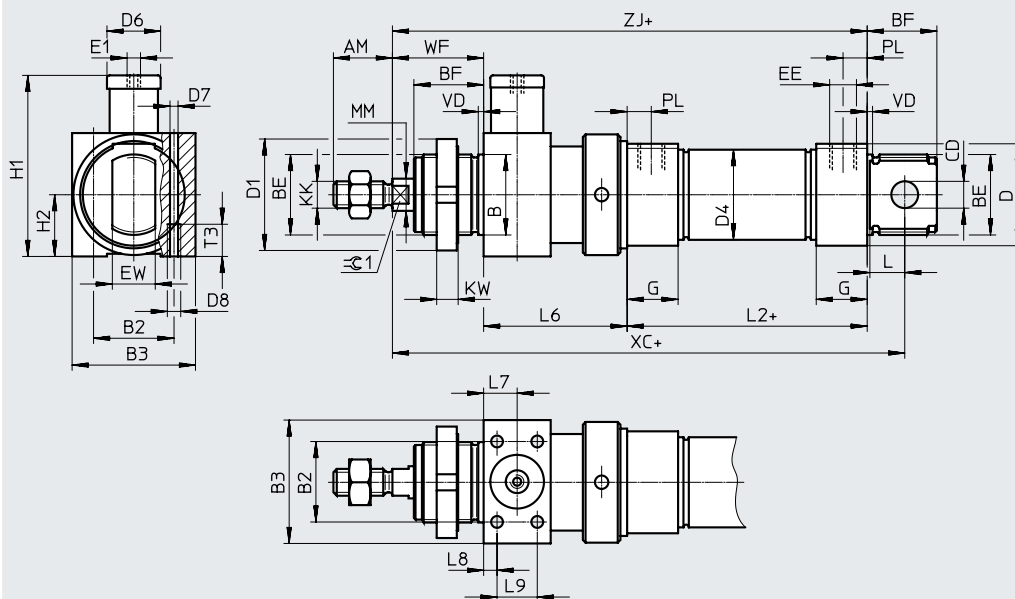

+ = plus stroke length

∅ [mm]	AM	B ∅ h9	B2	B3	BE	BF	CD ∅ E10	D ∅	D1 ∅	D4 ∅	D6	D7
32	22	30	30	46	M30x1.5	26	10	38	42	33.6	20	4.4
40	24	38	36	56	M38x1.5	30	12	46	50	41.6	24	6.8
50	32	45	50	65	M45x1.5	33	16	57	60	52.4	30	8.5
63			54	72	M45x1.5			70		65.4		

∅ [mm]	D8	E1	EE	EW	G	H1	H2	KK	KW	MM ∅	L	L2
32	M5	M5	G1/8	16	19	67.5	23	M10x1.25	8	12	13	69.5
40	M8	G1/8	G1/4	18	25	89	28	M12x1.25	10	16	15	84.6
50	M10	G1/8		21		107.5	32.5	M16x1.5		20	16	86.2
63		G1/8	G3/8	28	121.5	36				94.2		

∅ [mm]	L6	L7	L8	L9	T3	PL	VD	WF	XC	⊖1
	±0.75								±1	
32	55	12.5	5	15	12	9	2	34.5	173	10
40	69	17	7	20	18	12	3	40.5	210.1	13
50	78	20		26	20	20		45.5	226.7	17
63	86	24	8	32	21	13		46.5	243.7	

Data sheet

Dimensions

Download CAD data → www.festo.com

DSNU-32 ... 63

S2 – Through piston rod

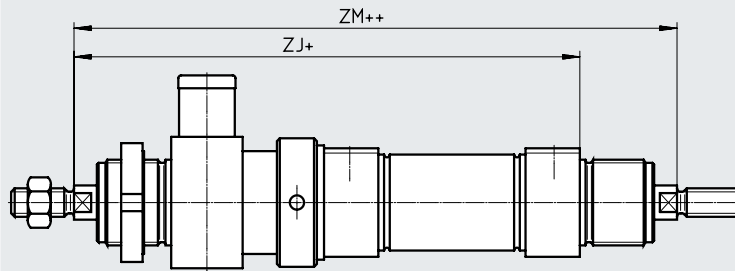

+ = plus stroke length
++ = plus 2x stroke length

Note

The thread types at both piston rod ends are identical. The clamping unit is mounted at only one end.

In combination with variant Q (→ page 46) the right piston rod is square, the left piston rod round. The clamping unit is mounted on the left-hand, round piston rod.

In combination with variant K8, the piston rod is only extended at the right piston rod. The clamping unit is mounted on the left piston rod that is not extended.

In combination with variant K8 and Q, the piston rod is only extended at the right, square piston rod.

∅ [mm]	ZJ	ZM
32	159	191
40	194.1	230.1
50	209.7	250.7
63	226.7	268.7

Ordering data – Modular product system

Ordering table										
Size	8	10	12	16	20	25	Conditions	Code	Enter code	
Module no.	193986	193987	193988	193989	193990	193991				
Function	Round cylinder, double-acting, based on ISO 6432								DSNU	DSNU
Piston ø [mm]	8	10	12	16	20	25		-...		
Stroke [mm]	1 ... 100		1 ... 200		1 ... 320	1 ... 500	[1]	-...		
Cushioning	Elastic cushioning rings/plates at both ends								-P	
	-	-	Pneumatic cushioning, adjustable at both ends				[2]	-PPV		
	-	-	-	Pneumatic cushioning, self-adjusting at both ends				[3]	-PPS	
Position sensing	Via proximity switch							[4]	-A	
Cylinder end cap	Lateral supply port, short end cap							[5]	-MQ	
	Axial supply port, short end cap							[5]	-MA	
Piston rod type	Through piston rod								-S2	

- [1] -... Longer strokes on request
- [2] PPV Not with MA
- [3] PPS Not with MA, MH and not with combination MQ-R3
- [4] A Minimum stroke: 10 mm
- [5] MQ, MA Not with S2

Ordering data – Modular product system

Ordering table		8	10	12	16	20	25	Conditions	Code	Enter code	
Extended male thread		Extended male piston rod thread									
	[mm]	1 ... 15	1 ... 20	1 ... 25	1 ... 35	[6]		-...K2			
Shortened male thread		Shortened male piston rod thread									
	[mm]	1 ... 4	1 ... 8	1 ... 10	[7]			-...K6			
Female thread		Piston rod with female thread									
		-	-	-	-	(M4)	(M6)	[8]	-K3		
Custom thread		Custom piston rod thread									
		-	-	-	-	-	M10		-“...”K5		
Extended piston rod at one end		Extended piston rod at one end									
	[mm]	1 ... 50	1 ... 100	1 ... 110	1 ... 150			...K8			
Clamping unit		Attached							-KP		-KP

[6] K2 Not with K3, K6

[7] K6 Not with K3

[8] K3 Not with K5

Ordering data – Modular product system

Ordering table							
Size	32	40	50	63	Conditions	Code	Enter code
Module no.	193992	193993	193994	193995			
Function	Double-acting round cylinder					DSNU	DSNU
Piston Ø [mm]	32	40	50	63		-...	
Stroke [mm]	1 ... 500				[1]	-...	
Cushioning	Elastic cushioning rings/plates at both ends					-P	
	Pneumatic cushioning, adjustable at both ends				[2]	-PPV	
	Pneumatic cushioning, self-adjusting at both ends				[3]	-PPS	
Position sensing	Via proximity switch				[4]	-A	
Cylinder end cap	Lateral supply port, short end cap				[5]	-MQ	
	Axial supply port, short end cap				[5]	-MA	
Piston rod type	Through piston rod					-S2	

- [1] -... Longer strokes on request
- [2] PPV Not with MA
- [3] PPS Not with MA, MH and not with combination MQ-R3
- [4] A Minimum stroke: 10 mm
- [5] MQ, MA Not with S2

Ordering data – Modular product system

Ordering table							
Size	32	40	50	63	Conditions	Code	Enter code
Extended male thread	Extended male piston rod thread						
	[mm]	1 ... 35		1 ... 70		[6]	-...K2
Shortened male thread	Shortened male piston rod thread						
	[mm]	1 ... 8		1 ... 10		[7]	-...K6
Female thread	Piston rod with female thread						
		(M6)	(M8)	(M10)		[8]	-K3
Custom thread	Custom piston rod thread						
		M10	M12	M16			-“...”K5
Extended piston rod at one end	Extended piston rod at one end						
	[mm]	1 ... 500					...K8
Clamping unit	Attached						
						-KP	-KP

[6] K2 Not with K3, K6
 [7] K6 Not with K3
 [8] K3 Not with K5

Round cylinders DSNU-Q, protected against rotation

Data sheet

P cushioning

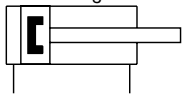

- - Diameter
12 ... 25 mm
ISO 6432

PPV cushioning

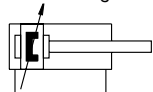

- - Diameter
32 ... 63 mm
- - Stroke length
5 ... 500 mm

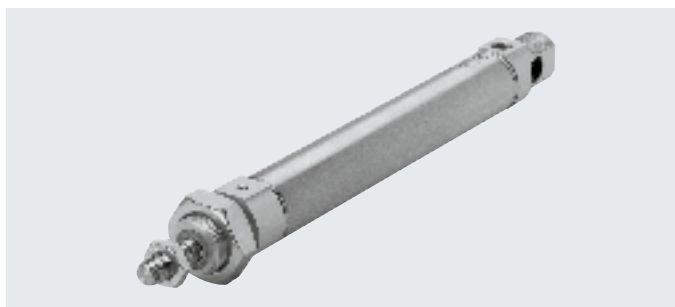

General technical data		12	16	20	25	32	40	50	63
Piston \varnothing		12	16	20	25	32	40	50	63
Based on standard		ISO 6432				-			
Pneumatic connection		M5	M5	G1/8	G1/8	G1/8	G1/4	G1/4	G3/8
Piston rod thread		M6	M6	M8	M10x1.25	M10x1.25	M12x1.25	M16x1.5	M16x1.5
Stroke ¹⁾	[mm]	5 ... 160		5 ... 200	5 ... 250	5 ... 300	5 ... 400		5 ... 500
Design		Piston Protected against rotation with square piston rod							
Max. torque at the piston rod	[Nm]	0.10	0.10	0.20	0.45	0.8	1.1	1.5	1.5
Cushioning		DSNU-...-P Elastic cushioning rings/plates at both ends							
		DSNU-...-PPV Pneumatic cushioning adjustable at both ends							
Cushioning length (PPV)	[mm]	-	12	15	17	14	18	20	21
Position sensing		Via proximity switch							
Type of mounting		With accessories							
Mounting position		Any							

- 1) Cylinders with position sensing require a minimum stroke of 10 mm to ensure reliable sensing.
Longer strokes on request

Operating and environmental conditions		12	16	20	25	32	40	50	63
Operating medium		Compressed air to ISO 8573-1:2010 [7:4:4]							
Note on the operating/pilot medium		Lubricated operation possible (in which case lubricated operation will always be required)							
Operating pressure	[bar]	1.5 ... 10 ¹⁾		1 ... 10					
Ambient temperature ²⁾		DSNU-... [°C] -20 ... +80							
		DSNU-Q-...-S6 [°C] -					0 ... +120		
Corrosion resistance class CRC ³⁾		DSNU-... 2							
		DSNU-Q-...-R3 3							

- 1) For DSNU-12-...-Q-PPV (pneumatic cushioning adjustable at both ends): 2 ... 10 bar
2) Note operating range of proximity switches
3) Corrosion resistance class CRC 2 to Festo standard FN 940070
Moderate corrosion stress. Indoor applications in which condensation can occur. External visible parts with primarily decorative surface requirements which are in direct contact with a normal industrial environment.
Corrosion resistance class CRC 3 to Festo standard FN 940070
High corrosion stress. Outdoor exposure under moderate corrosive conditions. Externally visible parts with primarily functional surface requirements which are in direct contact with a normal industrial environment.

Data sheet

ATEX ¹⁾	
ATEX category gas	II 2G
Type of ignition protection for gas	c T4
ATEX category for dust	II 2D
Type of ignition protection for dust	c 120°C
Explosion-proof ambient temperature	-20°C ≤ Ta ≤ +60°C
CE marking (see declaration of conformity)	To EU Explosion Protection Directive (ATEX)

1) Note the ATEX certification of the accessories.

Forces [N] and impact energy [J]								
Piston ø	12	16	20	25	32	40	50	63
Theoretical force at 6 bar, advancing	68	121	189	295	483	753	1178	1870
Theoretical force at 6 bar, retracting	51	104	158	247	415	633	990	1682
Impact energy in the end positions for P cushioning ¹⁾	0.07	0.15	0.20	0.30	0.40	0.70	1	1.3

1) The values are reduced by approx. 50% at an ambient temperature of 80°C

Weight [g]								
Piston ø	12	16	20	25	32	40	50	63
Product weight with 0 mm stroke	80	110	215	275	370.5	661	1087	1445
Additional weight per 10 mm stroke	4.1	4.7	7.1	10.9	15.5	24	40	44
Moving mass with 0 mm stroke	18.5	23	44	71	121	230	413	459
Moving mass per 10 mm stroke	2	2	4	6	9	16	25	25

Materials

Sectional view

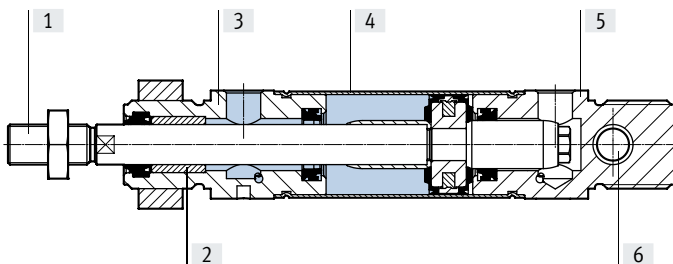

Round cylinder	
[1] Piston rod	
DSNU-...	High-alloy steel
DSNU-...-R3	High-alloy stainless steel
[2] Piston rod bearing	Sintered bronze
[3] Bearing cap	Anodised aluminium
[4] Cylinder barrel	High-alloy stainless steel
[5] End cap	Anodised aluminium
- Seals	TPE-U(PU), NBR
Note on materials	RoHS-compliant
[6] Swivel bearing	Polymer

Data sheet

Dimensions

Download CAD data → www.festo.com

DSNU-12 ... 25

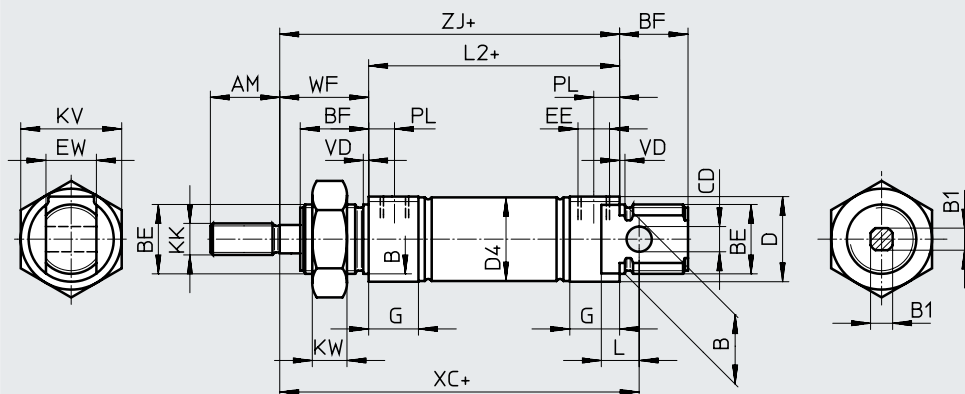

Note
 Piston rod nut is not included in the scope of delivery for diameter 12 ... 20.
 + = plus stroke length

∅	AM	B ∅ h9	B1 j	BE	BF	CD ∅ H9	D ∅	D4 ∅	EE	EW
12	16	16	5.5	M16x1.5	17	6	20	13.3	M5	12
16								17.3		
20	20	22	7	M22x1.5	20	8	27	21.3	G1/8	16
25	22		9		22			26.5		

∅	G	KK	KV	KW	L	L2	PL	VD	WF	XC ±1	ZJ
12	10	M6	24	8	9	50	6	2	22	75	72
16						56				82	78
20	16	M8	32	11	12	68	8.2		24	95	92
25		M10x1.25				69.5				28	104

S2 – Through piston rod

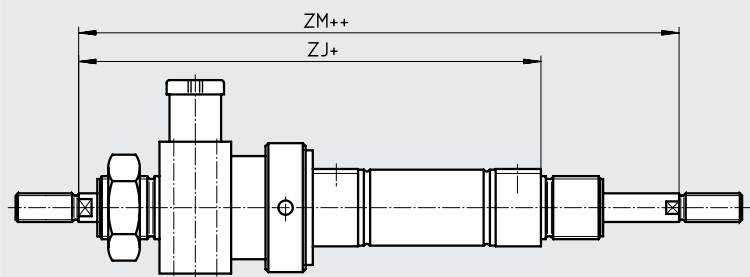

Note
 The thread types at both piston rod ends are identical. The clamping unit is mounted at only one end. In combination with variant Q, the right piston rod is square, the left piston rod round. The clamping unit is mounted on the left-hand, round piston rod.
 + = plus stroke length
 ++ = plus 2x stroke length

∅	ZJ	ZM
12	110	132
16	116	138
20	139	163
25	145.5	173.5

Data sheet

Dimensions

Download CAD data → www.festo.com

DSNU-32 ... 63

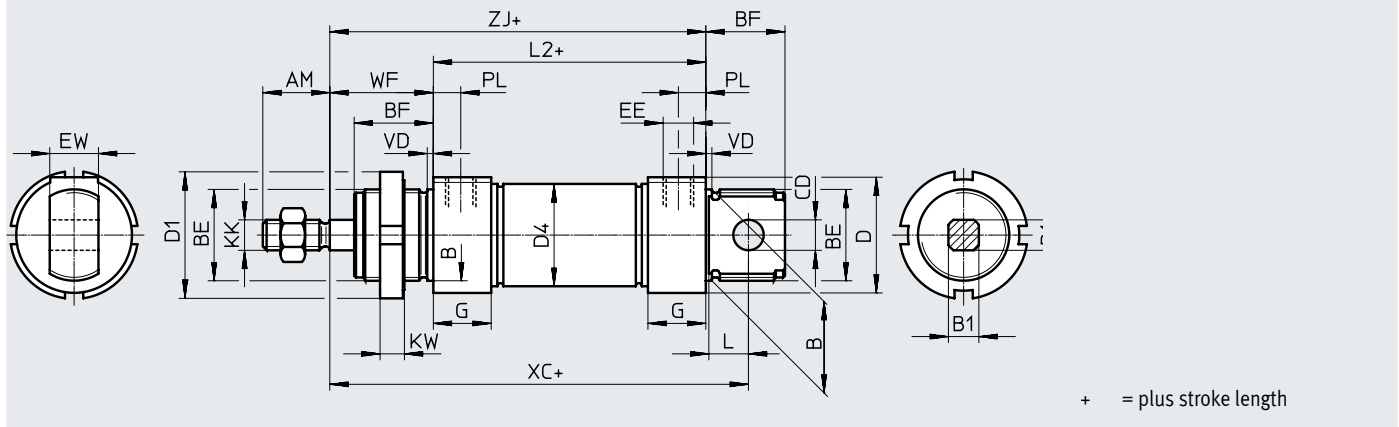

∅	AM	B ∅ h9	B1 j	BE	BF	CD ∅ E10	D ∅	D1 ∅	D4 ∅	EE	EW
32	22	30	10	M30x1.5	26	10	38	42	33.6	G1/8	16
40	24	38	12	M38x1.5	30	12	46	50	41.6	G1/4	18
50	32	45	16	M45x1.5	33	16	57	60	52.4	G1/4	21
63	32	45	16	M45x1.5	33	16	70	60	65.4	G3/8	21

∅	G	KK	KW	L	L2	PL	VD	WF	XC ±1	ZJ
32	19	M10x1.25	8	13	69.5	9	2	34	117.5	103.5
40	25	M12x1.25	10	15	84.6	12	3	39	139.6	123.6
50	25	M16x1.5	10	16	86.2	12	3	44	147.2	130.2
63	28	M16x1.5	10	16	94.2	13	3	45	156.2	139.2

S2 – Through piston rod

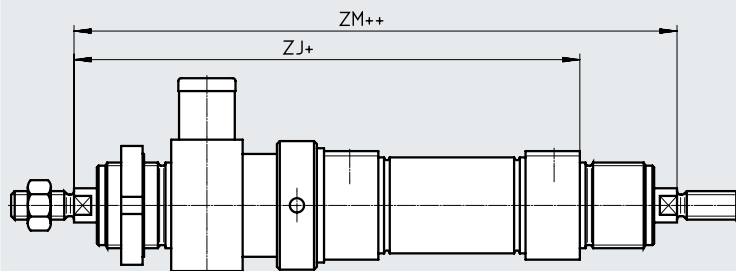

Note

The thread types at both piston rod ends are identical. The clamping unit is mounted at only one end. In combination with variant Q, the right piston rod is square, the left piston rod round. The clamping unit is mounted on the left-hand, round piston rod.

+ = plus stroke length
++ = plus 2x stroke length

∅	ZJ	ZM
32	159	191
40	194.1	230.1
50	209.7	250.7
63	226.7	268.7

Ordering data – Modular product system

Ordering table							
Size	12	16	20	25	Conditions	Code	Enter code
Module no.	193988	193989	193990	193991			
Function	Round cylinder, double-acting, based on ISO 6432						DSNU
Piston Ø [mm]	12	16	20	25		★ -...	
Stroke [mm]	5 ... 160		5 ... 200	5 ... 250	[1]	★ -...	
Cushioning	Elastic cushioning rings/plates at both ends	-	-	-		★ -P	
	-	Pneumatic cushioning, adjustable at both ends			[2]	★ -PPV	
Position sensing	Via proximity switch				[3]	★ -A	
Cylinder end cap	Lateral supply port, short end cap				[4]	★ -MQ	
	Axial supply port, short end cap	-	-	-	[4]	-MA	
	-	With mounting flange at front (direct mounting), bearing cap			[5]	-MH	
Protection against rotation	Square piston rod					★ -Q	-Q
Piston rod type	Through piston rod					★ -S2	

- [1] -... Longer strokes on request
- [2] PPV Not with MA
- [3] A Minimum stroke: 10 mm
- [4] MQ, MA Not with S2
- [5] MH Not with combination Q-R3

 **Note**

The bellows kit DADB must not be used in combination with the variant Q.

Ordering data – Modular product system

Ordering table		12	16	20	25	Conditions	Code	Enter code
Extended male thread		Extended male piston rod thread						
	[mm]	1 ... 20		1 ... 25	1 ... 35	[6]	-...K2	
Shortened male thread		Shortened male piston rod thread						
	[mm]	1 ... 4		1 ... 8	1 ... 10	[7]	-...K6	
Female thread		Piston rod with female thread						
		-	-	(M4)	(M6)	[8]	★ -K3	
Custom thread		Custom piston rod thread						
		-	-	-	M10		-“...”K5	
Extended piston rod at one end		Extended piston rod at one end						
	[mm]	1 ... 100		1 ... 110	1 ... 150		★ ...K8	
Clamping unit		Attached				[9]	-KP	
Corrosion protection		-	High corrosion protection				★ -R3	
EU certification		II 2GD				[10]	-EX4	

- [6] K2 Not with K3, K6
 [7] K6 Not with K3
 [8] K3 Not with K5
 [9] KP Only with S2. Not with R3
 [10] EX4 Not with KP

Ordering data – Modular product system

Ordering table							
Size	32	40	50	63	Conditions	Code	Enter code
Module no.	193992	193993	193994	193995			
Function	Double-acting round cylinder					DSNU	DSNU
Piston ø [mm]	32	40	50	63		★ -...	
Stroke [mm]	5 ... 300	5 ... 400		5 ... 500	[1]	★ -...	
Cushioning	Elastic cushioning rings/plates at both ends					★ -P	
	Pneumatic cushioning adjustable at both ends				[2]	★ -PPV	
Position sensing	Via proximity switch				[3]	★ -A	
Cylinder end cap	Lateral supply port, short end cap				[4]	★ -MQ	
	Axial supply port, short end cap				[4]	-MA	
	Mounting flange at front (direct mounting), bearing cap				[5]	-MH	
Protection against rotation	Square piston rod					★ -Q	-Q
Piston rod type	Through piston rod					★ -S2	

- [1] -... Longer strokes on request
 [2] PPV Not with MA
 [3] A Minimum stroke: 10 mm
 [4] MQ, MA Not with S2
 [5] MH Not with combinations: Q-R3, S6-R3. Not with KP

 - **Note**

The bellows kit DADB must not be used in combination with the variant Q.

Ordering data – Modular product system

Ordering table		32	40	50	63	Conditions	Code	Enter code
Extended male thread		Extended male piston rod thread						
	[mm]	1 ... 35		1 ... 70		[6]	-...K2	
Shortened male thread		Shortened male piston rod thread						
	[mm]	1 ... 8		1 ... 10		[7]	-...K6	
Female thread		Piston rod with female thread						
		(M6)	(M8)	(M10)		[8]	★ -K3	
Custom thread		Custom piston rod thread						
		M10	M12	M16			-“...”K5	
Extended piston rod at one end		Extended piston rod at one end						
	[mm]	1 ... 500					★ ...K8	
Clamping unit		Attached				[9]	-KP	
Temperature resistance		Heat-resistant seals max. 120°C					★ -S6	
Corrosion protection		High corrosion protection					★ -R3	
EU certification		II 2GD				[10]	-EX4	

[6]	K2	Not with K3, K6
[7]	K6	Not with K
[8]	K3	Not with K5
[9]	KP	Only with S2. Not with S6, R3
[10]	EX4	Not with KP, S6

Accessories

Foot mounting HBN/CRHBN

Scope of delivery:

HBN/CRHBN-...x1: 1 foot

HBN/CRHBN-...x2: 2 feet and 1 nut

Material:

HBN: Galvanised steel

CRHBN: High-alloy stainless steel

Free of copper and PTFE

RoHS-compliant

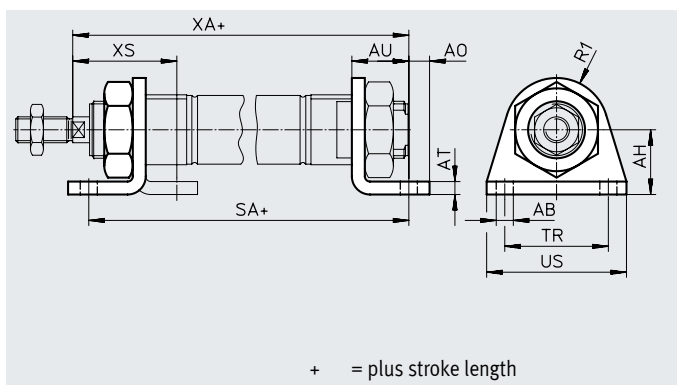

Dimensions and ordering data

For \varnothing [mm]	AB \varnothing	AH	AO	AT	AU	R1	SA		TR	US	XA		XS	
							DSNU-KP				DSNU-KP	DSNU-KP		
8, 10	4.5	16	5	3	11	10	68	97	25	35	73	102	24	-
12	5.5	20	6	4	14	13	78	116	32	42	86	124	32	-
16	5.5	20	6	4	14	13	84	122	32	42	92	130	32	-
20	6.6	25	8	5	17	20	102	149	40	54	109	156	36	-
25	6.6	25	8	5	17	20	103.5	151.5	40	54	114.5	162.5	40	-

For \varnothing [mm]	Basic version				High corrosion protection			
	CRC ¹⁾	Weight [g]	Part no.	Type	CRC ¹⁾	Weight [g]	Part no.	Type
8, 10	1	22	5123	HBN-8/10X1	-	-	-	
	1	54	5124	HBN-8/10X2	-	-	-	
12, 16	1	43	★ 5125	HBN-12/16X1	4	43	161866	CRHBN-12/16x1
	1	107	★ 5126	HBN-12/16X2	4	107	162999	CRHBN-12/16x2
20, 25	1	95	★ 5127	HBN-20/25X1	4	94	161867	CRHBN-20/25x1
	1	237	★ 5128	HBN-20/25X2	4	236	162998	CRHBN-20/25x2

1) Corrosion resistance class CRC 1 to Festo standard FN 940070

Low corrosion stress. Dry indoor application or transport and storage protection. Also applies to parts behind covers, in the non-visible interior area, and parts which are covered in the application (e.g. drive trunnions).

2) Corrosion resistance class CRC 4 to Festo standard FN 940070

Particularly high corrosion stress. Outdoor exposure under extreme corrosive conditions. Parts exposed to aggressive media, e.g. in the chemical or food industries. Such applications may need to be safeguarded by means of special testing (→ also FN 940082), using appropriate media.

Accessories

Foot mounting HBN/CRH

Material:

HBN: Galvanised steel

CRH: High-alloy stainless steel

Free of copper and PTFE

RoHS-compliant

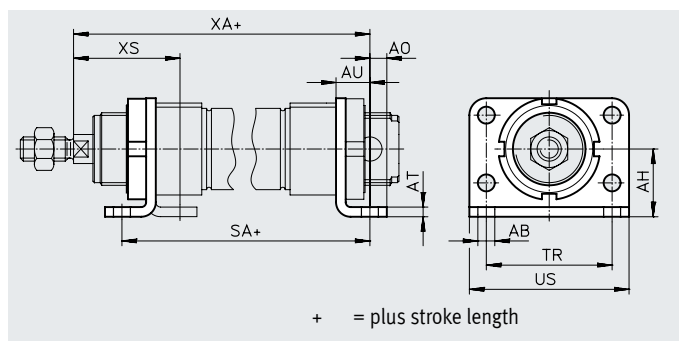

Dimensions and ordering data

For \varnothing [mm]	AB \varnothing	AH	AO	AT	AU	SA		TR	US	XA		XS	
							DSNU-KP				DSNU-KP		DSNU-KP
32	7	28	7	4	14	97.5	151	52	66	117.5	171	44	-
40	9	33	10	5	20	124.6	192.1	60	80	138.6	206.1	49	-
50	9	40	10	6	20	126.2	202.7	70	90	150.2	226.7	58	-
63	9	45	10	6	20	134.2	218.7	76	96	159.2	243.7	59	-

For \varnothing [mm]	Basic version				High corrosion protection			
	CRC ¹⁾	Weight [g]	Part no.	Type	CRC ¹⁾	Weight [g]	Part no.	Type
32	1	353	195851	HBN-32x2	4	353	162951	CRH-32
40	1	611	195852	HBN-40x2	4	611	162952	CRH-40
50	1	916	195853	HBN-50x2	4	916	162953	CRH-50
63	1	1066	195854	HBN-63x2	4	1066	162954	CRH-63

1) Corrosion resistance class CRC 1 to Festo standard FN 940070

Low corrosion stress. Dry indoor application or transport and storage protection. Also applies to parts behind covers, in the non-visible interior area, and parts which are covered in the application (e.g. drive trunnions).

Corrosion resistance class CRC 4 to Festo standard FN 940070

Particularly high corrosion stress. Outdoor exposure under extreme corrosive conditions. Parts exposed to aggressive media, e.g. in the chemical or food industries. Such applications may need to be safeguarded by means of special testing (→ also FN 940082), using appropriate media.

Accessories

Flange mounting FBN/CRFBN

Material:

FBN: Galvanised steel

CRFBN: High-alloy stainless steel

Free of copper and PTFE

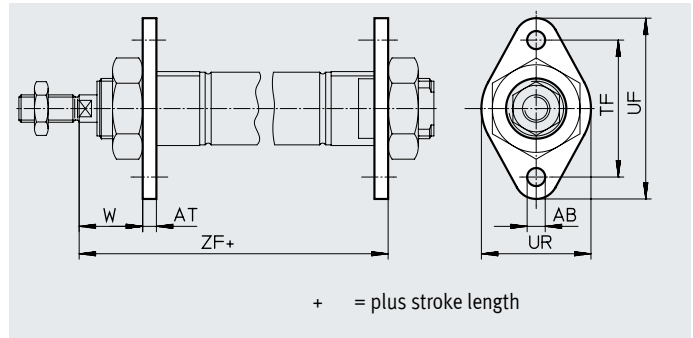

Dimensions and ordering data

For \varnothing [mm]	AB \varnothing	AT	TF	UF	UR	W	ZF	
								DSNU-KP
8, 10	4.5	3	30	40	25	13	65	94
12	5.5	4	40	53	30	18	76	114
16	5.5	4	40	53	30	18	82	120
20	6.6	5	50	66	40	19	97	144
25	6.6	5	50	66	40	23	102.5	150.5

For \varnothing [mm]	Basic version			High corrosion protection				
	CRC ¹⁾	Weight [g]	Part no.	Type	CRC ¹⁾	Weight [g]	Part no.	Type
8, 10	1	12	5129	FBN-8/10	–	–	–	–
12, 16	1	26	5130	FBN-12/16	4	26	161864	CRFBN-12/16
20, 25	1	52	5131	FBN-20/25	4	52	161865	CRFBN-20/25

1) Corrosion resistance class CRC 1 to Festo standard FN 940070

Low corrosion stress. Dry indoor application or transport and storage protection. Also applies to parts behind covers, in the non-visible interior area, and parts which are covered in the application (e.g. drive trunnions).

Corrosion resistance class CRC 4 to Festo standard FN 940070

Particularly high corrosion stress. Outdoor exposure under extreme corrosive conditions. Parts exposed to aggressive media, e.g. in the chemical or food industries. Such applications may need to be safeguarded by means of special testing (→ also FN 940082), using appropriate media.

Accessories

Flange mounting FBN/CRFV

Material:

FBN: Galvanised steel

CRFV: High-alloy stainless steel

Free of copper and PTFE

RoHS-compliant

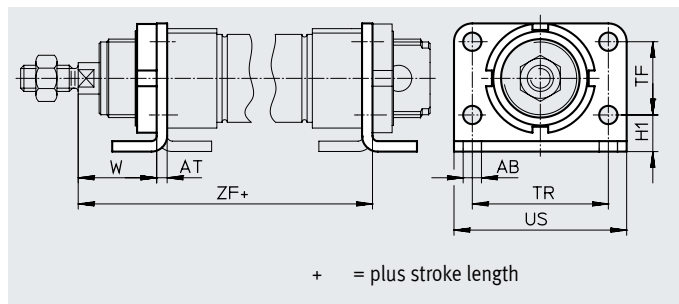

Dimensions and ordering data

For \varnothing [mm]	AB \varnothing	AT	H1	TF	TR	US	W	ZF	
									DSNU-KP
32	7	4	14	28	52	66	30	107.5	161
40	9	5	18	30	60	80	29	123.6	191.1
50	9	6	20	40	70	90	38	136.2	212.6
63	9	6	20	50	76	96	39	145.2	229.7

For \varnothing [mm]	Basic version				High corrosion protection			
	CRC ¹⁾	Weight [g]	Part no.	Type	CRC ¹⁾	Weight [g]	Part no.	Type
32	1	103	195855	FBN-32	4	103	161858	CRFV-32
40	1	191	195856	FBN-40	4	191	161859	CRFV-40
50	1	292	195857	FBN-50	4	292	161860	CRFV-50
63	1	367	195858	FBN-63	4	367	161861	CRFV-63

1) Corrosion resistance class CRC 1 to Festo standard FN 940070

Low corrosion stress. Dry indoor application or transport and storage protection. Also applies to parts behind covers, in the non-visible interior area, and parts which are covered in the application (e.g. drive trunnions).

Corrosion resistance class CRC 4 to Festo standard FN 940070

Particularly high corrosion stress. Outdoor exposure under extreme corrosive conditions. Parts exposed to aggressive media, e.g. in the chemical or food industries. Such applications may need to be safeguarded by means of special testing (→ also FN 940082), using appropriate media.

Accessories

Swivel mounting SBN

Material:
 Retaining ring: Anodised wrought aluminium alloy
 Bearing: Bronze
 Screws: Galvanised steel
 Bracket: Steel
 Cannot be used on the bearing cap in combination with bellows kit DADB.

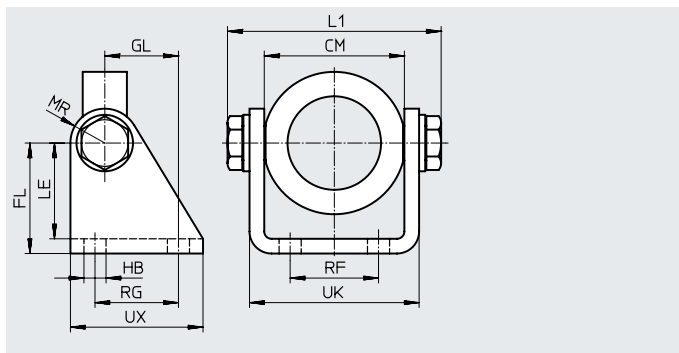

Dimensions and ordering data

For \varnothing [mm]	CM	FL	GL	HB	L1 max.	LE	MR	RF	RG	UK	UX	CRC ¹⁾	Weight [g]	Part no.	Type
20/25	38.1+0.4	35	20	7	60.2	31	12	20	24	46.1	40	1	238	539927	SBN-20/25
32	46.1+0.2	40	27	9	72.2	35	13	28	30	56.1	50	1	361	539924	SBN-32
40	57.1+0.2	45	30	9	88.2	39	14	36	34	69.1	54	1	593	539925	SBN-40
50/63	70.1+0.4	50	34	9	102.2	44	16	42	35	82.1	65	1	894	539926	SBN-50/63

1) Corrosion resistance class CRC 1 to Festo standard FN 940070
 Low corrosion stress. Dry indoor application or transport and storage protection. Also applies to parts behind covers, in the non-visible interior area, and parts which are covered in the application (e.g. drive trunnions).

Swivel mounting WBN

Material:
 Galvanised steel
 Free of copper and PTFE
 RoHS-compliant
 Cannot be used on the bearing cap in combination with bellows kit DADB.

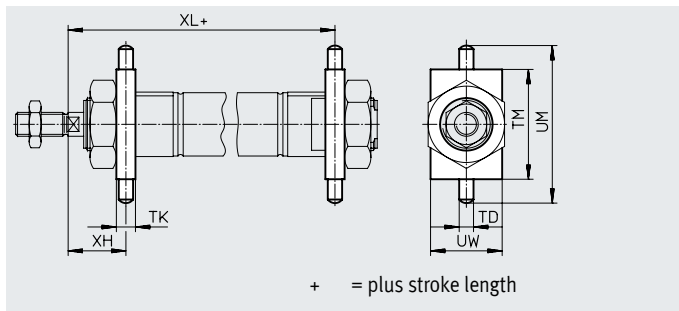
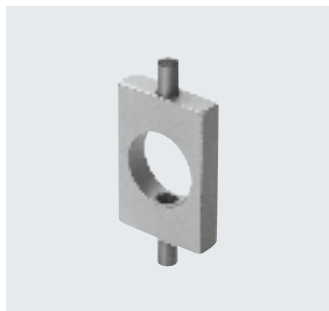

Dimensions and ordering data

For \varnothing [mm]	TD \varnothing -0.01/ -0.05	TK	TM	UM	UW	XH	XL		CRC ¹⁾	Weight [g]	Part no.	Type
								DSNU-KP				
8, 10	4	6	26	38	20	13	65	94	1	20	8608	WBN-8/10
12	6	8	38	58	25	18	76	114	1	51	8609	WBN-12/16
16	6	8	38	58	25	18	82	120	1	51	8609	WBN-12/16
20	6	8	46	66	30	20	96	143	1	67	8610	WBN-20/25
25	6	8	46	66	30	24	101.5	149.5	1	67	8610	WBN-20/25
32	8	12	50	76	40	28	109.5	163	1	131	195863	WBN-32
40	10	15	60	92	50	31.5	126.1	193.6	1	238	195864	WBN-40
50	12	20	80	116	65	34	140.2	216.7	1	596	195865	WBN-50/63
63	12	20	80	116	65	35	149.2	233.7	1	596	195865	WBN-50/63

1) Corrosion resistance class CRC 1 to Festo standard FN 940070
 Low corrosion stress. Dry indoor application or transport and storage protection. Also applies to parts behind covers, in the non-visible interior area, and parts which are covered in the application (e.g. drive trunnions).

Accessories

Clevis foot LBN/CRLBN

Material:

LBN: Galvanised steel

CRLBN: High-alloy stainless steel

Free of copper and PTFE

RoHS-compliant

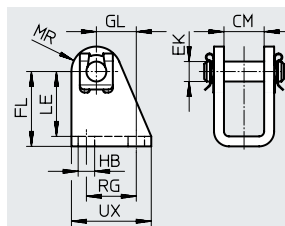

Dimensions and ordering data

For \varnothing [mm]	CM	EK \varnothing	FL	GL	HB	LE	MR	RG	UX
8, 10	8.1	4	24 +0.3/-0.2	13.8	4.5	21.5	5	12.5	20
12, 16	12.1	6	27 +0.3/-0.2	13	5.5	24	7	15	25
20, 25	16.1	8	30 +0.4/-0.2	16	6.6	26	10	20	32
32	16.1	10	35 +0.4/-0.2	18.5	6.6	31	11	24	35
40	18.1	12	40 +0.4/-0.2	24.5	9	35	13	30	45
50, 63	21.1	16	45 +0.5/-0.2	28	9	39	14	34	50

For \varnothing [mm]	Basic version				High corrosion protection			
	CRC ¹⁾	Weight [g]	Part no.	Type	CRC ¹⁾	Weight [g]	Part no.	Type
8, 10	1	20	6057	LBN-8/10	-	-	-	
12, 16	1	40	★ 6058	LBN-12/16	4	39	161862	CRLBN-12/16
20, 25	1	84	★ 6059	LBN-20/25	4	82	161863	CRLBN-20/25
32	1	110	195860	LBN-32	4	106	195866	CRLBN-32
40	1	191	195861	LBN-40	4	185	195867	CRLBN-40
50, 63	1	300	195862	LBN-50/63	4	283	195868	CRLBN-50/63



1) Corrosion resistance class CRC 1 to Festo standard FN 940070

Low corrosion stress. Dry indoor application or transport and storage protection. Also applies to parts behind covers, in the non-visible interior area, and parts which are covered in the application (e.g. drive trunnions).

Corrosion resistance class CRC 4 to Festo standard FN 940070

Particularly high corrosion stress. Outdoor exposure under extreme corrosive conditions. Parts exposed to aggressive media, e.g. in the chemical or food industries. Such applications may need to be safeguarded by means of special testing (→ also FN 940082), using appropriate media.

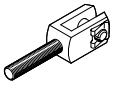
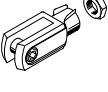
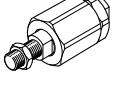
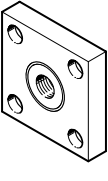
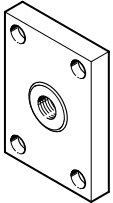
Accessories

Ordering data – Piston rod attachments				Data sheets → Internet: piston rod attachment			
Designation	For ø	Part no.	Type	Designation	For ø	Part no.	Type
Rod eye SGS				Rod clevis SGA			
	8	9253	SGS-M4		8	-	
	10				10		
	12	★ 9254	SGS-M6		12		
	16				16		
	20	★ 9255	SGS-M8		20		
	25	★ 9261	SGS-M10x1.25		25		
	32				32	32954	SGA-M10x1.25
	40	★ 9262	SGS-M12x1.25		40	10767	SGA-M12x1.25
	50	★ 9263	SGS-M16x1.5		50	10768	SGA-M16x1.5
63			63				
Rod clevis SG				Self-aligning rod coupler FK			
	8	6532	SG-M4		8	6528	FK-M4
	10				10		
	12	★ 3110	SG-M6		12	★ 2061	FK-M6
	16				16		
	20	★ 3111	SG-M8		20	★ 2062	FK-M8
	25	★ 6144	SG-M10x1.25		25	★ 6140	FK-M10x1.25
	32				32		
	40	★ 6145	SG-M12x1.25		40	★ 6141	FK-M12x1.25
	50	★ 6146	SG-M16x1.5		50	★ 6142	FK-M16x1.5
63			63				
Coupling piece KSG				Coupling piece KSZ			
	12	-			12	36123	KSZ-M6
	16				16		
	20				20	36124	KSZ-M8
	25	32963	KSG-M10x1.25		25	36125	KSZ-M10x1.25
	32				32		
	40	32964	KSG-M12x1.25		40	36126	KSZ-M12x1.25
	50	32965	KSG-M16x1.5		50	36127	KSZ-M16x1.5
63			63				
Hex nut MSK							
	16	189007	MSK-M16X1.5				
	20	★ 189009	MSK-M22X1.5				
	25						

Accessories

Ordering data – Piston-rod attachments, corrosion-resistant

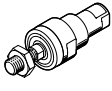
Designation	For \varnothing	Part no.	Type
Rod eye CRSGS			
	12	195580	CRSGS-M6
	16		
	20	195581	CRSGS-M8
	25	195582	CRSGS-M10x1.25
	32		
	40	195583	CRSGS-M12x1.25
	50	195584	CRSGS-M16x1.5
63			
Self-aligning rod coupler CRFK			
	25	2305778	CRFK-M10x1.25
	32		
	40	2305779	CRFK-M12x1.25
	50	2490673	CRFK-M16x1.5
	63		

Data sheets → Internet: piston rod attachment

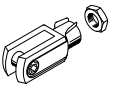
Designation	For \varnothing	Part no.	Type
Rod clevis CRSG			
	12	13567	CRSG-M6
	16		
	20	13568	CRSG-M8
	25	13569	CRSG-M10x1.25
	32		
	40	13570	CRSG-M12x1.25
	50	13571	CRSG-M16x1.5
63			

Ordering data – Mounting components

Designation	For \varnothing	Part no.	Type
Clevis foot LBG			
	32	31761	LBG-32
	40	31762	LBG-40
	50	31763	LBG-50
	63	31764	LBG-63

Data sheets → Internet: clevis foot

Designation	For \varnothing	Part no.	Type
Right angle clevis foot LQG			
	32	31768	LQG-32
	40	31769	LQG-40
	50	31770	LQG-50
	63	31771	LQG-63

Ordering data – Guide units

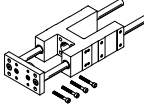
	For \varnothing	Stroke [mm]	With recirculating ball bearing guide		With plain-bearing guide	
			Part no.	Type	Part no.	Type
	8, 10	1 ... 100	35197	FEN-8/10-...-KF	35196	FEN-8/10-...-GF
	12, 16	1 ... 200	33481	FEN-12/16-...-KF	19168	FEN-12/16-...-GF
	20	2 ... 250	33482	FEN-20-...-KF	19169	FEN-20-...-GF
	25	2 ... 250	33483	FEN-25-...-KF	19170	FEN-25-...-GF

Data sheets → Internet: feng

Accessories

Bellows kit DADB



General technical data									
Type DADB-S1-		12	16	20	25	32	40	50	63
Max. stroke range of the cylinder ¹⁾									
DSNU	[mm]	10 ... 200	10 ... 200	10 ... 320	10 ... 500				
Type of mounting		Via threaded pin							
Mounting position		Any							
Media resistance		Dust, chippings, oil, grease, fuel (→ Internet: media resistance)							
Ambient temperature ²⁾	[°C]	-10 ... +80							
Corrosion resistance class CRC ³⁾		3							

1) In conjunction with the bellows kit DADB

2) Note operating range of proximity switches and cylinder

3) Corrosion resistance class CRC 3 to Festo standard FN 940070

High corrosion stress. Outdoor exposure under moderate corrosive conditions. Externally visible parts with primarily functional surface requirements which are in direct contact with a normal industrial environment.

Materials

Sectional view

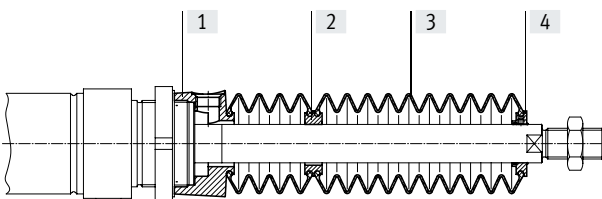

Bellows		
[1]	Connection	Polyamide
[2]	Adapter	Polyamide
[3]	Bellows	NBR
[4]	End piece	Polyamide
-	O-ring	NBR
	Note on materials	Free of copper and PTFE
		RoHS-compliant

Accessories

Weight [g]				
Type DADB-S1- Stroke [mm]	12	16	20	25
10 ... 50	7	7	20	19
51 ... 100	9	9	32	31
101 ... 150	13	13	45	44
151 ... 200	16	16	58	57
201 ... 250	-	-	73	72
251 ... 300	-	-	85	84
301 ... 350	-	-	100	98
351 ... 400	-	-	-	109
401 ... 450	-	-	-	124
451 ... 500	-	-	-	136

Type DADB-S1- Stroke [mm]	32	40	50	63
10 ... 50	29	34	55	55
51 ... 125	41	49	75	75
126 ... 175	51	60	89	89
176 ... 250	66	78	113	113
251 ... 300	79	93	131	131
301 ... 350	92	108	149	149
351 ... 375	92	108	151	151
376 ... 425	104	122	169	169
426 ... 475	117	137	187	187
476 ... 500	117	137	189	189

Accessories

Travel speed v as a function of tubing length l



The bellows kit is a leak-free system. To prevent unwanted media from being drawn in, the supply and exhaust air must be ducted via a pressure compensation hole in the connection part. The pressure generated in the bellows kit by the positioning motion is primarily defined by the travel speed and tubing length. The recommended tubing length based on the travel speed of the drive can be read from the graph.

Advancing

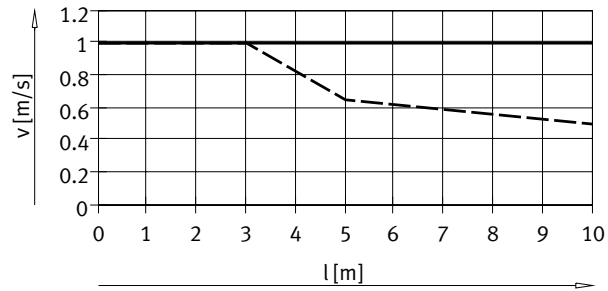
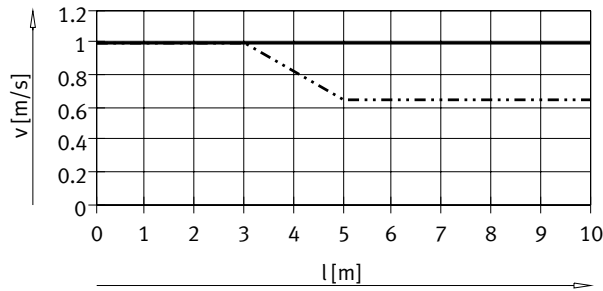

— DSNU-12/16
- · - · - DSNU-20/25

— DSNU-32/50/63
- - - - - DSNU-40

Retracting

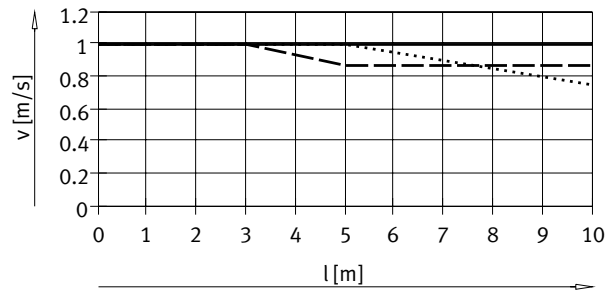
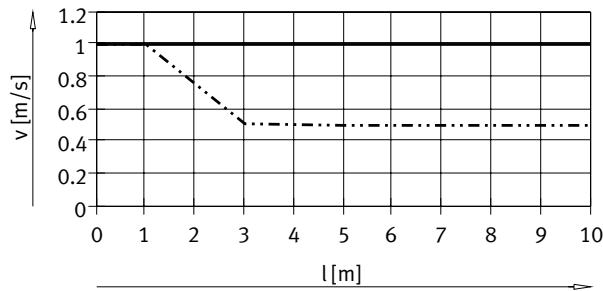

— DSNU-12/16
- · - · - DSNU-20/25

— DSNU-32
- - - - - DSNU-40
- · - · - DSNU-50/63

 Note
The push-in fittings in the adjacent table must be used for the pressure compensation hole. Silencers can be used as an alternative. This reduces the travel speed slightly.

Tubing size and push-in fitting for pressure compensation hole			
∅ [mm]	Tubing O.D. [mm]	Push-in fitting	
		Part no.	Type
12, 16, 20, 25	6	★ 153317	QSM-M5-6-I
		578371	NPQH-DK-M5-Q6-P10
		578335	NPQH-D-M5-Q6-P10
		578359	NPQH-D-M5-S6-P10
32, 40	8	★ 186109	QS-G1/8-8-I
		578376	NPQH-DK-G18-Q8-P10
		578362	NPQH-D-G18-S8-P10
50, 63	12	★ 186350	QS-G1/4-12
		578344	NPQH-D-G14-Q12-P10
		578366	NPQH-D-G14-S12-P10

Accessories

Dimensions

Download CAD data → www.festo.com

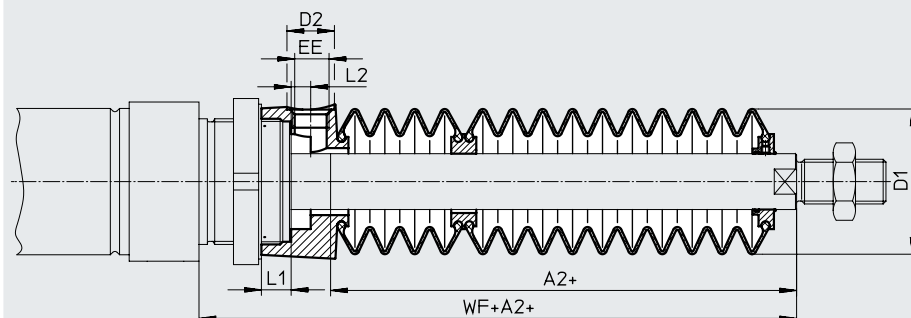

∅ Stroke [mm]	12/16							20						
	A2 ¹⁾	D1 max.	D2	EE	L1	L2	WF+A2	A2 ¹⁾	D1 max.	D2	EE	L1	L2	WF+A2
10 ... 50	23	22	8.5	M5	5	3.2	45	22	29	8.5	M5	4.2	2.7	46
51 ... 100	34						56	34						58
101 ... 150	48						70	47						71
151 ... 200	59						81	60						84
201 ... 250	–						–	75						99
251 ... 300	–						–	86						110
301 ... 350	–						–	101						125
351 ... 400	–						–	–						–
401 ... 450	–						–	–						–
451 ... 500	–	–	–	–										

∅ Stroke [mm]	25						WF+A2
	A2 ¹⁾	D1 max.	D2	EE	L1	L2	
10 ... 50	22	29	8.5	M5	4.2	2.7	50
51 ... 100	34						62
101 ... 150	47						75
151 ... 200	60						88
201 ... 250	75						103
251 ... 300	86						114
301 ... 350	101						129
351 ... 400	112						140
401 ... 450	127						155
451 ... 500	138	166					

1) The dimension corresponds to the K8 value (extended piston rod) of the drive

Accessories

Dimensions

Download CAD data → www.festo.com

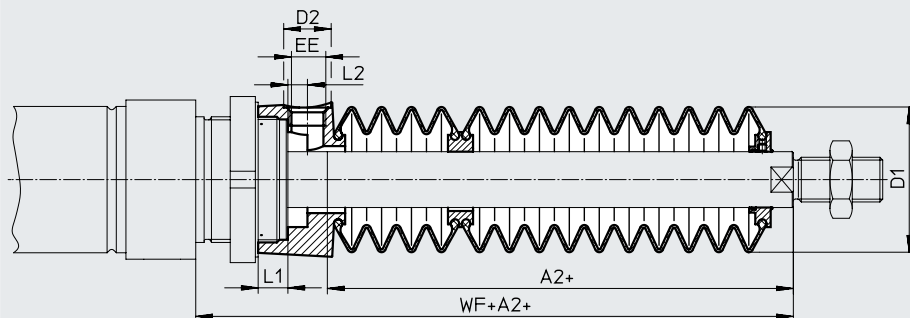

∅ Stroke [mm]	32							40						
	A2 ¹⁾	D1 max.	D2	EE	L1	L2	WF+A2	A2 ¹⁾	D1 max.	D2	EE	L1	L2	WF+A2
10 ... 50	30	38	14	G1/8	12.9	5.4	64	29	46	14	G1/8	8.1	5.4	68
51 ... 125	48						82	44						83
126 ... 175	63						97	57						96
176 ... 250	82						116	73						112
251 ... 300	97						131	87						126
301 ... 350	113						147	101						140
351 ... 375	115						149	102						141
376 ... 425	131						165	116						155
426 ... 475	147						181	131						170
476 ... 500	149						183	132						171

∅ Stroke [mm]	50/63						
	A2 ¹⁾	D1 max.	D2	EE	L1	L2	WF+A2
10 ... 50	30	57	17	G1/4	10.65	7	74/75
51 ... 125	48						92/93
126 ... 175	58						102/103
176 ... 250	77						121/122
251 ... 300	88						132/133
301 ... 350	99						143/144
351 ... 375	106						150/151
376 ... 425	117						161/162
426 ... 475	128						172/173
476 ... 500	135						179/180

1) The dimension corresponds to the K8 value (extended piston rod) of the drive

Accessories

Ordering data – Bellows kit

An extended piston rod (order code K8) is absolutely essential when using a bellows kit → Ordering data – Modular product system.

The necessary dimension for K8 as a function of piston diameter and cylinder stroke as well as the corresponding bellows kit is indicated in the table below:

Order example:

Selected round cylinder:

DSNU-25-320-PPV-A-MQ-...

The dimension for the corresponding K8 value (see table): 101 mm

Complete order reference for round cylinder:

DSNU-25-320-PPV-A-MQ-...-101K8

The corresponding bellows kit:

DADB-S1-25-S301-350

Cylinder data			Bellows kit		
∅	Stroke	Dimension for K8	Part no.	Type	
[mm]	[mm]	[mm]			
12	10 ... 50	23	553391	DADB-S1-12-S10-50	
	51 ... 100	34	553393	DADB-S1-12-S51-100	
	101 ... 150	48	553395	DADB-S1-12-S101-150	
	151 ... 200	59	553397	DADB-S1-12-S151-200	
20	10 ... 50	22	553407	DADB-S1-20-S10-50	
	51 ... 100	34	553409	DADB-S1-20-S51-100	
	101 ... 150	47	553411	DADB-S1-20-S101-150	
	151 ... 200	60	553413	DADB-S1-20-S151-200	
	201 ... 250	75	553415	DADB-S1-20-S201-250	
	251 ... 300	86	553417	DADB-S1-20-S251-300	
	301 ... 320	101	553419	DADB-S1-20-S301-350	
32	10 ... 50	30	553441	DADB-S1-32-S10-50	
	51 ... 125	48	553443	DADB-S1-32-S51-125	
	126 ... 175	63	553445	DADB-S1-32-S126-175	
	176 ... 250	82	553447	DADB-S1-32-S176-250	
	251 ... 300	97	553449	DADB-S1-32-S251-300	
	301 ... 350	113	553451	DADB-S1-32-S301-350	
	351 ... 375	115	553453	DADB-S1-32-S351-375	
	376 ... 425	131	553455	DADB-S1-32-S376-425	
	426 ... 475	147	553457	DADB-S1-32-S426-475	
	476 ... 500	149	553459	DADB-S1-32-S476-500	
50	10 ... 50	30	553481	DADB-S1-50-S10-50	
	51 ... 125	48	553483	DADB-S1-50-S51-125	
	126 ... 175	58	553485	DADB-S1-50-S126-175	
	176 ... 250	77	553487	DADB-S1-50-S176-250	
	251 ... 300	88	553489	DADB-S1-50-S251-300	
	301 ... 350	99	553491	DADB-S1-50-S301-350	
	351 ... 375	106	553493	DADB-S1-50-S351-375	
	376 ... 425	117	553495	DADB-S1-50-S376-425	
	426 ... 475	128	553497	DADB-S1-50-S426-475	
	476 ... 500	135	553499	DADB-S1-50-S476-500	
	16	10 ... 50	23	553399	DADB-S1-16-S10-50
51 ... 100		34	553401	DADB-S1-16-S51-100	
101 ... 150		48	553403	DADB-S1-16-S101-150	
151 ... 200		59	553405	DADB-S1-16-S151-200	
25		10 ... 50	22	553421	DADB-S1-25-S10-50
		51 ... 100	34	553423	DADB-S1-25-S51-100
		101 ... 150	47	553425	DADB-S1-25-S101-150
		151 ... 200	60	553427	DADB-S1-25-S151-200
		201 ... 250	75	553429	DADB-S1-25-S201-250
		251 ... 300	86	553431	DADB-S1-25-S251-300
		301 ... 350	101	553433	DADB-S1-25-S301-350
		351 ... 400	112	553435	DADB-S1-25-S351-400
	401 ... 450	127	553437	DADB-S1-25-S401-450	
451 ... 500	138	553439	DADB-S1-25-S451-500		
40	10 ... 50	29	553461	DADB-S1-40-S10-50	
	51 ... 125	44	553463	DADB-S1-40-S51-125	
	126 ... 175	57	553465	DADB-S1-40-S126-175	
	176 ... 250	73	553467	DADB-S1-40-S176-250	
	251 ... 300	87	553469	DADB-S1-40-S251-300	
	301 ... 350	101	553471	DADB-S1-40-S301-350	
	351 ... 375	102	553473	DADB-S1-40-S351-375	
	376 ... 425	116	553475	DADB-S1-40-S376-425	
	426 ... 475	131	553477	DADB-S1-40-S426-475	
	476 ... 500	132	553479	DADB-S1-40-S476-500	
63	10 ... 50	30	553501	DADB-S1-63-S10-50	
	51 ... 125	48	553503	DADB-S1-63-S51-125	
	126 ... 175	58	553505	DADB-S1-63-S126-175	
	176 ... 250	77	553507	DADB-S1-63-S176-250	
	251 ... 300	88	553509	DADB-S1-63-S251-300	
	301 ... 350	99	553511	DADB-S1-63-S301-350	
	351 ... 375	106	553513	DADB-S1-63-S351-375	
	376 ... 425	117	553515	DADB-S1-63-S376-425	
	426 ... 475	128	553517	DADB-S1-63-S426-475	
	476 ... 500	135	553519	DADB-S1-63-S476-500	

Accessories

Ordering data – Proximity switch, round design, magneto-resistive¹⁾ Data sheets → Internet: smto

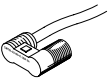
	Mounting	Switching output	Electrical connection		Cable length [m]	Outlet direction of connection	Part no.	Type
			Cable	Plug M8				
N/O contact								
	With accessories	PNP	3-wire	–	2.5	In-line	152836	SMTO-4U-PS-K-LED-24
			–	3-pin	–	In-line	152742	SMTO-4U-PS-S-LED-24
		NPN	3-wire	–	2.5	In-line	152837	SMTO-4U-NS-K-LED-24
			–	3-pin	–	In-line	152743	SMTO-4U-NS-S-LED-24

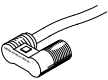

Ordering data – Proximity switch, round design, magnetic reed¹⁾ Data sheets → Internet: smeo

	Mounting	Electrical connection		Cable length [m]	Outlet direction of connection	Part no.	Type	
		Cable	Plug M8					
N/O contact								
	With accessories	3-wire	–	2.5	In-line	36198	SMEO-4U-K-LED-24	
			5	In-line	175401	SMEO-4U-K5-LED-24		
		–	3-pin	–	In-line	151526	SMEO-4U-S-LED-24-B	

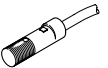
Ordering data – Proximity switches, round design, magnetic reed, corrosion-resistant¹⁾ Data sheets → Internet: crsmeo

	Mounting	Electrical connection		Cable length [m]	Outlet direction of connection	Part no.	Type	
		Cable	Plug M8					
N/O contact								
	With accessories	3-wire	–	2.5	In-line	161775	CRSMEO-4-K-LED-24	

Ordering data – Mounting kits for proximity switch SMEO/SMTO/CRSMEO¹⁾ Data sheets → Internet: smbr

Designation	For ø	Part no.	Type	Designation	For ø	Part no.	Type
Mounting kit SMBR				Mounting kit CRSMBR, corrosion resistant			
	8	19272	SMBR-8		8	–	–
	10	19273	SMBR-10		10	–	–
	12	19274	SMBR-12		12	164581	CRSMBR-12
	16	19275	SMBR-16		16	164582	CRSMBR-16
	20	19276	SMBR-20		20	164583	CRSMBR-20
	25	19277	SMBR-25		25	164584	CRSMBR-25
					32	163888	CRSMBR-32
					40	163889	CRSMBR-40
					50	163890	CRSMBR-50
					63	163891	CRSMBR-63

Accessories

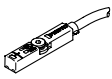
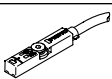
Ordering data – Proximity switch for T-slot, magneto-resistive							Data sheets → Internet: smt
	Type of mounting	Switching output	Electrical connection	Cable length [m]	Part no.	Type	
N/O contact							
	Inserted in the slot from above, flush with the cylinder profile, short design	PNP	Cable, 3-wire	2.5	★ 574335	SMT-8M-A-PS-24V-E-2.5-OE	
			Plug M8x1, 3-pin	0.3	★ 574334	SMT-8M-A-PS-24V-E-0.3-M8D	
		NPN	Plug M12x1, 3-pin	0.3	★ 574337	SMT-8M-A-PS-24V-E-0.3-M12	
			Cable, 3-wire	2.5	★ 574338	SMT-8M-A-NS-24V-E-2.5-OE	
			Plug M8x1, 3-pin	0.3	★ 574339	SMT-8M-A-NS-24V-E-0.3-M8D	
N/C contact							
	Inserted in the slot from above, flush with the cylinder profile, short design	PNP	Cable, 3-wire	7.5	★ 574340	SMT-8M-A-PO-24V-E-7.5-OE	

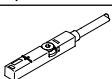
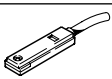
Ordering data – Proximity switch for T-slot, magnetic reed							Data sheets → Internet: sme
	Type of mounting	Switching output	Electrical connection	Cable length [m]	Part no.	Type	
N/O contact							
	Inserted in the slot from above, flush with the cylinder profile	Contacting	Cable, 3-wire	2.5	★ 543862	SME-8M-DS-24V-K-2.5-OE	
				5.0	★ 543863	SME-8M-DS-24V-K-5.0-OE	
			Cable, 2-wire	2.5	★ 543872	SME-8M-ZS-24V-K-2.5-OE	
			Plug M8x1, 3-pin	0.3	★ 543861	SME-8M-DS-24V-K-0.3-M8D	
N/C contact							
	Inserted in the slot lengthwise, flush with the cylinder profile	Contacting	Cable, 3-wire	7.5	160251	SME-8-O-K-LED-24	

Ordering data – Mounting kits for proximity switch SME/SMT-8				Data sheets → Internet: smbr
Designation	For Ø	Part no.	Type	
Mounting kit SMBR-8				
	8	175091	SMBR-8-8	
	10	175092	SMBR-8-10	
	12	★ 175093	SMBR-8-12	
	16	★ 175094	SMBR-8-16	
	20	★ 175095	SMBR-8-20	
	25	★ 175096	SMBR-8-25	
	32	175097	SMBR-8-32	
	40	175098	SMBR-8-40	
	50	175099	SMBR-8-50	
63	175100	SMBR-8-63		

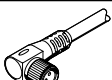
Ordering data – Connecting cables						Data sheets → Internet: nebu
	Electrical connection, left	Electrical connection, right	Cable length [m]	Part no.	Type	
	Straight socket, M8x1, 3-pin	Cable, open end, 3-wire	2.5	★ 541333	NEBU-M8G3-K-2.5-LE3	
			5	★ 541334	NEBU-M8G3-K-5-LE3	
	Straight socket, M12x1, 5-pin	Cable, open end, 3-wire	2.5	★ 541363	NEBU-M12G5-K-2.5-LE3	
			5	★ 541364	NEBU-M12G5-K-5-LE3	
	Angled socket, M8x1, 3-pin	Cable, open end, 3-wire	2.5	★ 541338	NEBU-M8W3-K-2.5-LE3	
			5	★ 541341	NEBU-M8W3-K-5-LE3	
	Angled socket, M12x1, 5-pin	Cable, open end, 3-wire	2.5	541367	NEBU-M12W5-K-2.5-LE3	
			5	541370	NEBU-M12W5-K-5-LE3	

Accessories

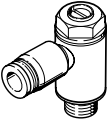
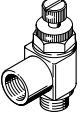
Ordering data – One-way flow control valves					Data sheets → Internet: grl			
	Connection Thread	For tubing O.D.	Material	Part no.	Type			
For exhaust air								
	M5	3	Metal design	★ 193137	GRLA-M5-QS-3-D			
		4		★ 193138	GRLA-M5-QS-4-D			
		6		★ 193139	GRLA-M5-QS-6-D			
	G1/8	3		★ 193142	GRLA-1/8-QS-3-D			
		4		★ 193143	GRLA-1/8-QS-4-D			
		6		★ 193144	GRLA-1/8-QS-6-D			
		8		★ 193145	GRLA-1/8-QS-8-D			
	G1/4	6		★ 193146	GRLA-1/4-QS-6-D			
		8		★ 193147	GRLA-1/4-QS-8-D			
		10		★ 193148	GRLA-1/4-QS-10-D			
	G3/8	6		★ 193149	GRLA-3/8-QS-6-D			
		8		★ 193150	GRLA-3/8-QS-8-D			
		10		★ 193151	GRLA-3/8-QS-10-D			
	For supply air							
		M5		3	Metal design	★ 193153	GRLZ-M5-QS-3-D	
4			★ 193154	GRLZ-M5-QS-4-D				
6			★ 193155	GRLZ-M5-QS-6-D				
G1/8		3	★ 193156	GRLZ-1/8-QS-3-D				
		4	★ 193157	GRLZ-1/8-QS-4-D				
		6	★ 193158	GRLZ-1/8-QS-6-D				
		8	★ 193159	GRLZ-1/8-QS-8-D				