

One-way flow control valves GRLA, GRLZ

FESTO



Festo Core Range
Solves the majority of your automation tasks

Worldwide:
Simply good:
Fast:

Quickest delivery – wherever, whenever
Expected high Festo quality
Easy and fast to select

With the Festo Core Range, we have selected the most important products and functions from our broad product catalogue, and added the quickest delivery.

The Core Range offers you the best value for your automation tasks.

Just look
for the
star!

Key features

Function

The piston speed of both advancing and retracting pneumatic drives, can be regulated using one-way flow control valves.

This is done through suitable restriction of the flow rate of compressed air in exhaust air or supply air direction. The non-return function works in the opposite direction.

The flow control function creates an adjustable annular gap inside the valve. This gap can be increased or decreased by turning the knurled screw or slotted head screw.

The required restriction can be set with the help of this adjustment element.

General information

Standard nominal flow rate q_{nN}

The standard nominal flow rate q_{nN} is the volumetric flow rate based on standard conditions at an operating pressure of $p_1 = 6$ bar and an output pressure of $p_2 = 5$ bar, measured at room temperature $t = 20^\circ\text{C}$.

Standard flow rate q_n

The standard flow rate q_n is measured at an operating pressure of $p_1 = 6$ bar and an output pressure with respect to atmospheric pressure ($p_2 = 0$ bar).

Symbols

Exhaust air one-way flow control function

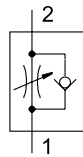

Supply air one-way flow control function

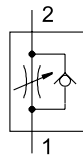

Connections

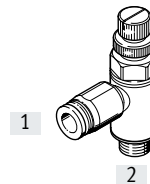

- [1] Pneumatic connection 1 (compressed air connection)
- [2] Pneumatic connection 2 (working port)

Key features

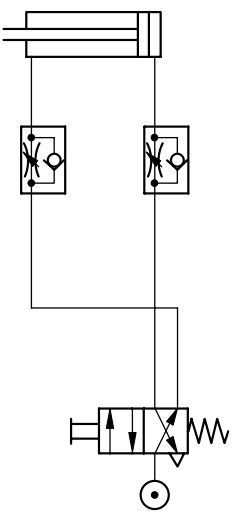
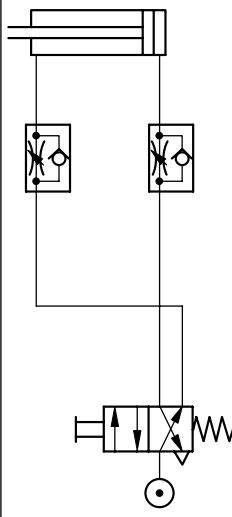
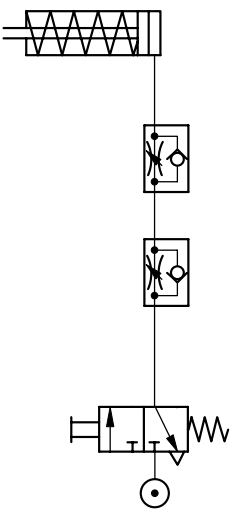
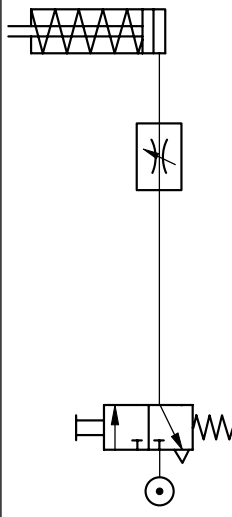
Flow control functions and range of applications		Flow control functions and range of applications	
Application	Description	Application	Description
Double-acting cylinder with one-way flow control valve			
Exhaust air one-way flow control function		Supply air one-way flow control function	
	<p>Speed adjustment through exhaust air flow control. Uncontrolled supply air and throttled exhaust air move the piston between air cushions (improves motion, even with load changes).</p>		<p>Adjustable speed during advance and return strokes. The flow rate is identical in both directions.</p>
Single-acting cylinder with one-way flow control valve		Single-acting cylinder with flow control valve	
Exhaust air and supply air one-way flow control function		Flow control function in both directions	
	<p>Adjustable speed during advance and return strokes. The flow rate can be adjusted differently for both directions.</p>		<p>Speed adjustment through flow control on both sides is often used with single-acting or small cylinders. The benefit of this application is its simplicity.</p>



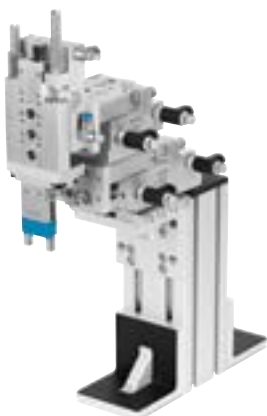

Application examples

Mini slide SLT with one-way flow control valve, standard

Flat cylinder DZF with one-way flow control valve, mini

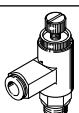





Product range overview – One-way flow control valves

Version	Valve function	Version	Type	Outlet direction of connection	Pneumatic connection 1	Pneumatic connection 2	qn ¹⁾ [l/min]	Adjusting element	→ Page/ Internet
Standard									
Polymer									
Exhaust air one-way flow control function		VFOE-LE	Elbow outlet	QS-4, QS-6, QS-8, QS-10, QS-12	M5, G1/8, G1/4, G3/8, G1/2, R1/8, R1/4, R3/8, R1/2	90 ... 1200	Rotary knob with detent	vfoe	
		GRLA	Elbow outlet	QS-6, QS-8	G1/8, G1/4, G3/8	520 ... 650	Knurled screw	19	
Supply air one-way flow control function		VFOE-LS	Elbow outlet	QS-4, QS-6, QS-8	M5, M7, G1/8, R1/8	90 ... 180	Rotary knob with detent	vfoe	
Metal									
Exhaust air one-way flow control function		GRLA	Elbow outlet	QS-3, QS-4, QS-6, QS-8, QS-10, QS-12	M5, G1/8, G1/4, G3/8, G1/2	100 ... 1580	Slotted head screw Knurled screw	7	
				M5, G1/8, G1/4, G3/8, G1/2, G3/4	M5, G1/8, G1/4, G3/8, G1/2, G3/4	95 ... 4320	Slotted head screw		
				M5, G1/8, G1/4	M5, G1/8, G1/4	95 ... 610	Knurled screw		
				PK-3, PK-4, PK-6	M5, G1/8, G1/4	83 ... 540	Slotted head screw		
Supply air one-way flow control function		GRLZ	Elbow outlet	QS-3, QS-4, QS-6, QS-8	M5, G1/8	100 ... 215	Slotted head screw	7	
				M5, G1/8, G1/4	M5, G1/8, G1/4	95 ... 610	Slotted head screw Knurled screw		
				PK-3, PK-4, PK-6	M5, G1/8, G1/4	83 ... 540	Slotted head screw		
				VFOC-S	Elbow outlet	QS-4, QS-6	Push-in sleeve ²⁾ QS-4, QS-6		0 ... 270
Nickel-plated metal									
Exhaust air one-way flow control function		VFOH-LE	Elbow outlet	QS-4, QS-6, QS-8, QS-10	G1/8, G1/4	180 ... 530	External hex	vfoh	

1) Standard nominal flow rate in flow control direction.

2) Only suitable for push-in connector QS.

Product range overview – One-way flow control valves

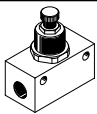
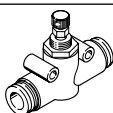
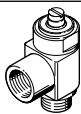
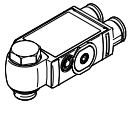
Version	Valve function	Version	Type	Outlet direction of connection	Pneumatic connection 1	Pneumatic connection 2	qnN ¹⁾ [l/min]	Adjusting element	→ Page/ Internet
Mini	Metal Exhaust air one-way flow control function		GRLA	Elbow outlet	QS-3, QS-4	M3, M5	40 ... 41	Slotted head screw	21
					M3	M3	0 ... 18		
	Supply air one-way flow control function		GRLZ	Elbow outlet	QS-3, QS-4	M3, M5	41 ... 48	Slotted head screw	
					M3	M3	0 ... 18		Slotted head screw
In-line installation	Metal One-way flow control function		GR/GRA	Straight	M3, M5, G1/8, G1/4, G3/8, G1/2, G3/4	M3, M5, G1/8, G1/4, G3/8, G1/2, G3/4	29.5 ... 3300	Knurled screw	gr
		Polymer One-way flow control function		GR	Straight	QS-3, QS-4, QS-6, QS-8	QS-3, QS-4, QS-6, QS-8	85 ... 265	Knurled screw
Corrosion-resistant	Stainless steel Exhaust air one-way flow control function		CRGRLA	Elbow outlet	M5, G1/8, G1/4, G3/8, G1/2	M5, G1/8, G1/4, G3/8, G1/2	95 ... 2100	Slotted head screw	26
Function combination	Polymer Exhaust air one-way flow control function		VFOF	Elbow outlet	QS-6, QS-8	G1/8, G1/4	240 ... 590	Internal hex	vfof

1) Standard nominal flow rate in flow control direction.

One-way flow control valves

Type codes

001	Series
GRLA	One-way flow control valve
GRLSA	One-way flow control valve
CRGRLA	One-way flow control valve, corrosion resistant
GRLZ	One-way flow control valve

002	Pneumatic connection
M3	Male thread M3
M5	Male thread M5
1/8	Male thread G1/8
1/4	Male thread G1/4
3/8	Male thread G3/8
1/2	Male thread G1/2
3/4	Male thread G3/4

003	Pneumatic connection 1
	Connection size as for port 1 or 2
QS-3	Push-in connector 3 mm
QS-4	Push-in connector 4 mm
QS-6	Push-in connector 6 mm
QS-8	Push-in connector 8 mm
QS-10	Push-in connector 10 mm
QS-12	Push-in connector 12 mm
PK-3	CK connection 3 mm
PK-4	CK connection 4 mm
PK-6	CK connection 6 mm

004	Adjusting component
	Standard
RS	Knurled screw

005	Flow rate characteristic
	None
LF	Low flow
MF	Medium flow

006	Generation
	None
B	Series B
C	Series C
D	D series

Datasheet – Push-in connector QS, metal

One-way flow control function
Exhaust air Supply air

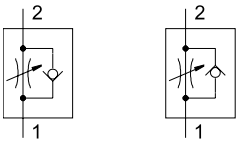

- - Flow rate
100 ... 1580 l/min
- - Temperature range
-10 ... +60°C
- - Operating pressure
0.2 ... 10 bar

Can be rotated 360° around the screw-in axis after mounting.



General technical data – GRLA					
Pneumatic connection 2	M5	G1/8	G1/4	G3/8	G1/2
Pneumatic connection 1	QS-3, QS-4, QS-6	QS-3, QS-4, QS-6, QS-8	QS-6, QS-8, QS-10	QS-6, QS-8, QS-10	QS-12
Valve function	Exhaust air one-way flow control function				
Adjusting element	Slotted head screw Knurled screw				
Type of mounting	Screw-in with male thread				
Mounting position	Any				
Nominal tightening torque [Nm]	0.8 ±10%	3 ±10%	5 ±10%	10 ±10%	15 ±10%

General technical data – GRLZ		
Pneumatic connection 2	M5	G1/8
Pneumatic connection 1	QS-3, QS-4, QS-6	QS-3, QS-4, QS-6, QS-8
Valve function	Supply air one-way flow control function	
Adjusting element	Slotted head screw	
Type of mounting	Screw-in with male thread	
Mounting position	Any	
Nominal tightening torque [Nm]	0.8 ±10%	3 ±10%

Operating and environmental conditions	
Operating pressure for full temperature range [bar]	0.2 ... 10
Operating medium	Compressed air to ISO 8573-1:2010 [7:4:4]
Note on the operating/pilot medium	Lubricated operation possible (in which case lubricated operation will always be required)
Ambient temperature [°C]	-10 ... +60
Temperature of medium [°C]	-10 ... +60
Storage temperature [°C]	-10 ... +40
Maritime classification	See certificate ¹⁾

1) Additional information: www.festo.com/catalogue/... → Support/Downloads

Standard nominal flow rate q_{nN} at 6 → 5 bar as a function of spindle rotations n

GRLA/GRLZ-M5

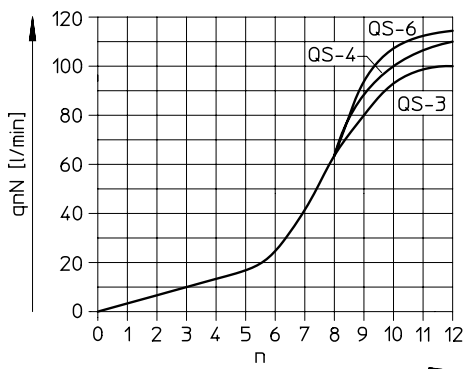

Standard flow rate q_n at 6 → 0 bar as a function of spindle rotations n

GRLA/GRLZ-M5

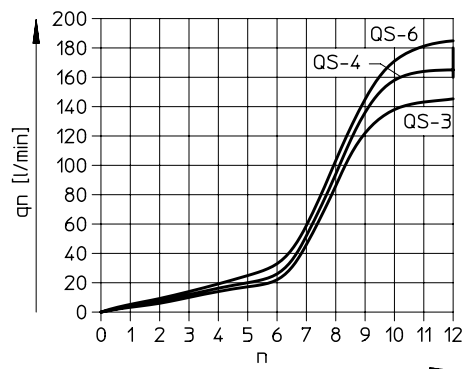

Datasheet – Push-in connector QS, metal

Standard nominal flow rate q_{nN} at 6 → 5 bar as a function of spindle rotations n

GRLA/GRLZ-1/8

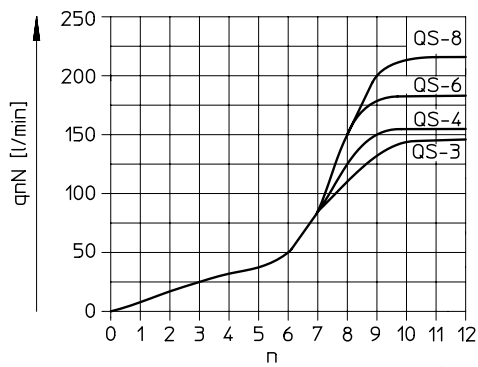

Standard flow rate q_n at 6 → 0 bar as a function of spindle rotations n

GRLA/GRLZ-1/8

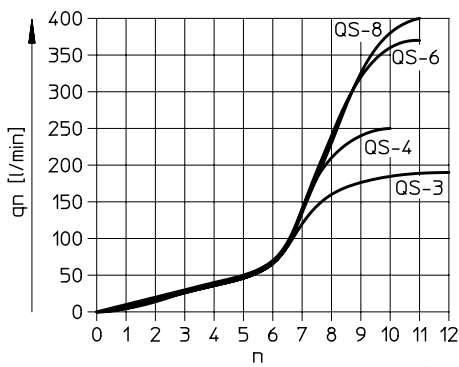

GRLA-1/8....MF, GRLA-1/4

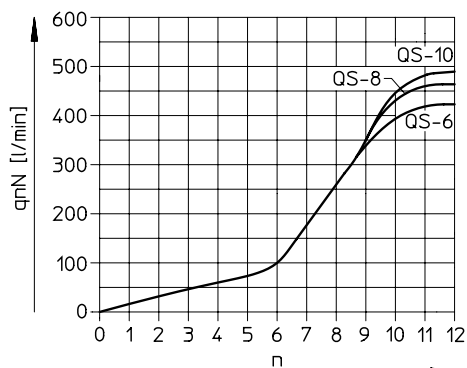

GRLA-1/8....MF, GRLA-1/4

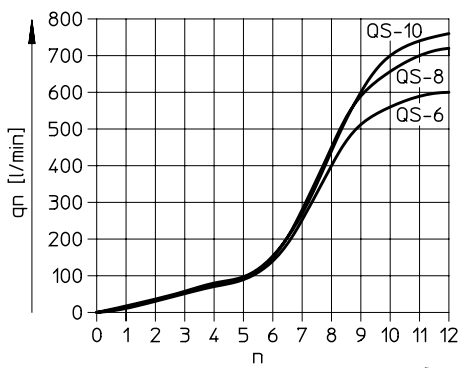

GRLA-3/8

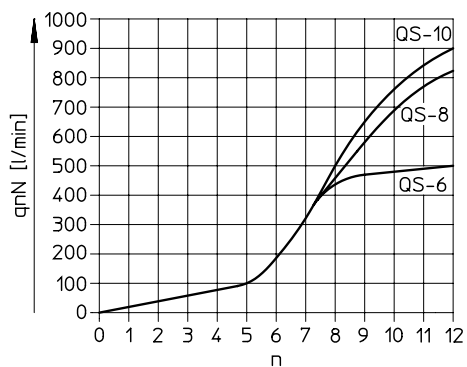

GRLA-3/8

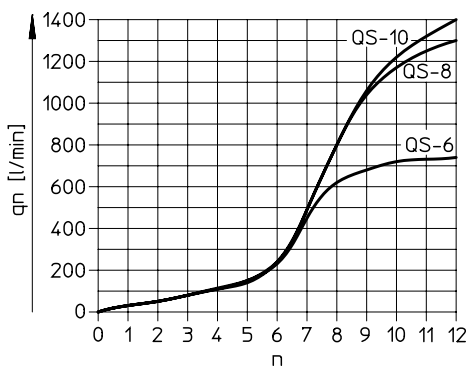

GRLA-1/2

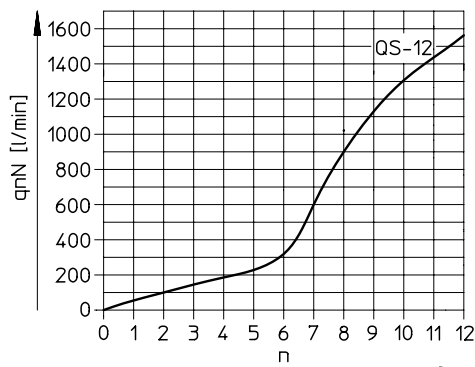

GRLA-1/2

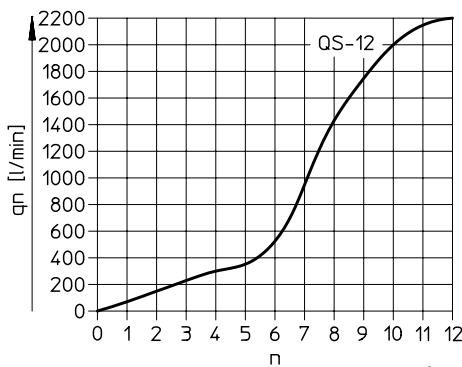

Datasheet – Push-in connector QS, metal

Materials

Sectional view

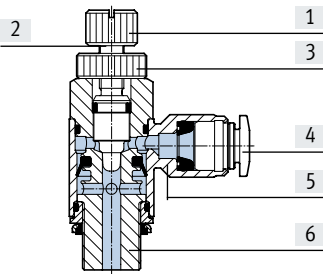

One-way flow control valve		
[1]	Knurled head (GRLA...-RS only)	Anodised wrought aluminium alloy
[2]	Adjusting screw	Brass
[3]	Hollow bolt (GRLA...-RS only)	Anodised wrought aluminium alloy
[4]	Releasing ring	POM
[5]	Swivel connection	Chromated die-cast zinc
[6]	Screwed trunnion	Anodised wrought aluminium alloy GRLA/GRLZ-M5: Brass
-	Seals	NBR
Note on materials		RoHS-compliant

Dimensions

Slotted head screw

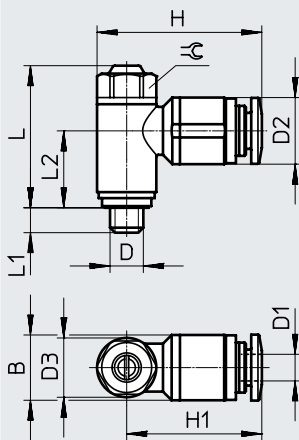

Knurled screw

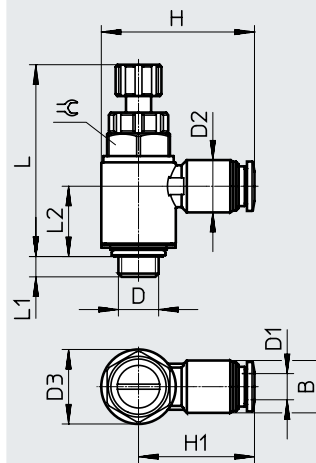

Download CAD data → www.festo.com

Type	Connection D	Tubing O.D. D1	B	D2 ø	D3 ø	~H	~H1	~L		L1	~L2	⊕
								Slotted head screw	Knurled screw			
GRL...-M5	M5	3	-	8.2 ±0.15	8.9 ±0.07	22.4	18	20.8 ±3.3%	31.5 ±2.4%	3.9 +0.1/-0.45	10.7	8
		4	9.8 ±0.2	10.0 ±0.2		24.7	20.3				9.7	
		6	-	12.0 ±0.2		26.5	22					
GRL...-1/8	G1/8	3	-	10.2 ±0.2	13.8 ±0.07	31.9	25	26.5 ±2.1%	40.4 ±1.6%	5.05 +0.15/-0.3	14.2	12
		4		10.2 ±0.2		29.4	22.5				13.5	
		6		12.5 ±0.2		32.6	25.7					
		8		14.5 ±0.2		35.6	28.7					
GRLA-1/8-...-MF	G1/8	6	-	12.5 ±0.2	17.8 ±0.15	36.6	27.7	30.9 ±1.9%	-	5.05 +0.15/-0.3	17	15
		8		14.5 ±0.2		39.6	30.7					
GRLA-1/4	G1/4	6	-	12.5 ±0.2	17.8 ±0.15	36.6	27.7	31.5 ±1.9%	48.5 ±1.4%	5.9 +0.17/-0.25	17.2	15
		8		14.5 ±0.2		39.6	30.7				16.1	
		10		17.5 ±0.2		42.0	33.1					
GRLA-3/8	G3/8	6	-	12.5 ±0.2	22.4 ±0.15	39.8	28.6	35.3 ±1.7%	55 ±1.3%	6.9 +0.15/-0.3	19.55	19
		8		14.5 ±0.2		44.1	32.9					
		10		17.5 ±0.2		46.7	35.5					
GRLA-1/2	G1/2	12	-	20.5 ±0.15	27.8 ±0.15	55.3	41.4	42.6 ±1.4%	65.9 ±1.1%	8.35 +0.15/-0.3	22.75	24

Datasheet – Push-in connector QS, metal

★ Core Range

Ordering data – Exhaust air one-way flow control function								
Pneumatic connection		Standard nominal flow rate qnN at 6 → 5 bar		Standard flow rate qn at 6 → 0 bar		Weight [g]	Part no.	Type
		In flow control direction	In non-return direction	In flow control direction	In non-return direction			
2	1	[l/min]	[l/min]	[l/min]	[l/min]			

Slotted head screw										
	M5	QS-3	100	60 ... 100	145	150 ... 170	13	★ 193137	GRLA-M5-QS-3-D	
		QS-4	110	65 ... 110	165	140 ... 160		★ 193138	GRLA-M5-QS-4-D	
		QS-6	115	70 ... 110	185	145 ... 170		★ 193139	GRLA-M5-QS-6-D	
	G1/8	QS-3	130	100 ... 130	180	200 ... 220	22	★ 193142	GRLA-1/8-QS-3-D	
		QS-4	160	120 ... 190	250	270 ... 300		★ 193143	GRLA-1/8-QS-4-D	
		QS-6	185	160 ... 240	370	330 ... 390		★ 193144	GRLA-1/8-QS-6-D	
		G1/4	QS-6	400	290 ... 420	600	570 ... 680	32	★ 537075	GRLA-1/8-QS-6-MF-D
			QS-8	215	175 ... 250	400	330 ... 410		★ 193145	GRLA-1/8-QS-8-D
			G3/8	QS-6	495	320 ... 495	740	840 ... 890	60	★ 193149
	QS-8			820	450 ... 850	1300	1080 ... 1420	★ 193150		GRLA-3/8-QS-8-D
	G1/2	QS-10	900	540 ... 975	1400	1160 ... 1620	32	★ 537076	GRLA-1/8-QS-8-MF-D	
		QS-12	1580	925 ... 1605	2220	1910 ... 2500		★ 193152	GRLA-1/2-QS-12-D	

Knurled screw									
	M5	QS-3	100	60 ... 100	145	150 ... 170	14	★ 197576	GRLA-M5-QS-3-RS-D
		QS-4	110	65 ... 110	165	140 ... 160		★ 197577	GRLA-M5-QS-4-RS-D
		QS-6	115	70 ... 110	185	145 ... 170		★ 197578	GRLA-M5-QS-6-RS-D
	G1/8	QS-3	130	100 ... 130	180	200 ... 220	23	★ 197579	GRLA-1/8-QS-3-RS-D
		QS-4	160	120 ... 190	250	270 ... 300		★ 197580	GRLA-1/8-QS-4-RS-D
		QS-6	185	160 ... 240	370	330 ... 390		★ 197581	GRLA-1/8-QS-6-RS-D
		G1/4	QS-8	215	175 ... 250	400	330 ... 410	24	★ 534337
	QS-6		400	290 ... 420	600	570 ... 680	50	★ 534338	GRLA-1/4-QS-6-RS-D
	QS-8		475	325 ... 500	720	610 ... 760		★ 534339	GRLA-1/4-QS-8-RS-D
	G3/8	QS-10	480	345 ... 500	760	630 ... 790	72	★ 534340	GRLA-1/4-QS-10-RS-D
		QS-6	495	320 ... 495	740	840 ... 890		★ 534341	GRLA-3/8-QS-6-RS-D
		QS-8	820	450 ... 850	1300	1080 ... 1420		★ 534342	GRLA-3/8-QS-8-RS-D
	G1/2	QS-10	900	540 ... 975	1400	1160 ... 1620	124	★ 534343	GRLA-3/8-QS-10-RS-D
		QS-12	1580	925 ... 1605	2220	1910 ... 2500		★ 534344	GRLA-1/2-QS-12-RS-D

Ordering data – Supply air one-way flow control function								
Pneumatic connection		Standard nominal flow rate qnN at 6 → 5 bar		Standard flow rate qn at 6 → 0 bar		Weight [g]	Part no.	Type
		In flow control direction	In non-return direction	In flow control direction	In non-return direction			
2	1	[l/min]	[l/min]	[l/min]	[l/min]			

Slotted head screw									
	M5	QS-3	100	60 ... 100	135	130 ... 160	13	★ 193153	GRLZ-M5-QS-3-D
		QS-4	110	65 ... 110	160	150 ... 180		★ 193154	GRLZ-M5-QS-4-D
		QS-6	115	70 ... 110	170	160 ... 200		★ 193155	GRLZ-M5-QS-6-D
	G1/8	QS-3	130	100 ... 130	200	180 ... 200	22	★ 193156	GRLZ-1/8-QS-3-D
		QS-4	160	120 ... 190	300	260 ... 290		★ 193157	GRLZ-1/8-QS-4-D
		QS-6	185	160 ... 240	340	390 ... 460		★ 193158	GRLZ-1/8-QS-6-D
		QS-8	215	175 ... 250	370	390 ... 470		★ 193159	GRLZ-1/8-QS-8-D



Datasheet – Female thread/barbed connector, metal

One-way flow control function

Exhaust air

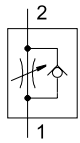
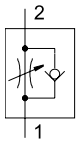
Supply air



-  - Flow rate
83 ... 4320 l/min
-  - Temperature range
-10 ... +60°C
-  - Operating pressure
0.2 ... 10 bar



GRLA/GRLZ

GRLA/GRLZ-...-RS

GRLA/GRLZ-...-PK

General technical data – GRLA

Connection type	Female thread						Barbed connector		
	M5	G1/8	G1/4	G3/8	G1/2	G3/4	M5	G1/8	G1/4
Pneumatic connection 2	M5	G1/8	G1/4	G3/8	G1/2	G3/4	M5	G1/8	G1/4
Pneumatic connection 1	M5 ¹⁾	G1/8 ¹⁾	G1/4 ¹⁾	G3/8 ¹⁾	G1/2 ¹⁾	G3/4 ¹⁾	PK-3, PK-4	PK-3, PK-4, PK-6	PK-4, PK-6
Valve function	Exhaust air one-way flow control function								
Adjusting element	Slotted head screw								
	Knurled screw -								
Type of mounting	Screw-in								
Mounting position	Any								
Max. tightening torque [Nm]	1.5	6	11	20	40	60	1.5	6	11

 1)  Note: This product conforms to ISO 1179-1 and ISO 228-1.

General technical data – GRLZ

Connection type	Female thread			Barbed connector		
	M5	G1/8	G1/4	M5	G1/8	G1/4
Pneumatic connection 2	M5	G1/8	G1/4	M5	G1/8	G1/4
Pneumatic connection 1	M5 ¹⁾	G1/8 ¹⁾	G1/4 ¹⁾	PK-3, PK-4	PK-3, PK-4, PK-6	PK-4, PK-6
Valve function	Supply air one-way flow control function					
Adjusting element	Slotted head screw					
	Knurled screw -					
Type of mounting	Screw-in					
Mounting position	Any					
Max. tightening torque [Nm]	1.5	6	11	1.5	6	11

 1)  Note: This product conforms to ISO 1179-1 and ISO 228-1.

Operating and environmental conditions

Pneumatic connection 2	M5	G1/8	G1/4	G3/8	G1/2	G3/4
Operating pressure for full temperature range [bar]	0.2 ... 10		0.3 ... 10			
Operating medium	Compressed air to ISO 8573-1:2010 [7:4:4]					
Note on the operating/pilot medium	Lubricated operation possible (in which case lubricated operation will always be required)					
Ambient temperature [°C]	-10 ... +60					
Temperature of medium [°C]	-10 ... +60					
Storage temperature [°C]	-10 ... +40					
Maritime classification	GRLA: see certificate ¹⁾					

 1) Additional information: www.festo.com/catalogue/... → Support/Downloads

Datasheet – Female thread/barbed connector, metal

Standard nominal flow rate q_{nN} at 6 → 5 bar as a function of spindle rotations n

GRLA/GRLZ-M5

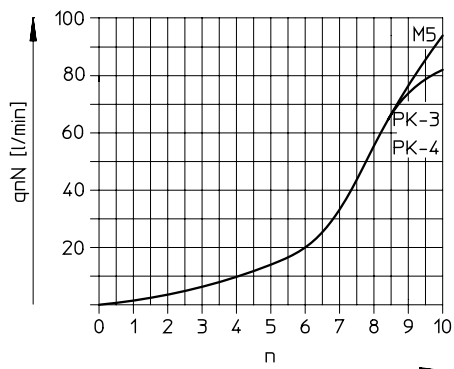

Standard flow rate q_n at 6 → 0 bar as a function of spindle rotations n

GRLA/GRLZ-M5

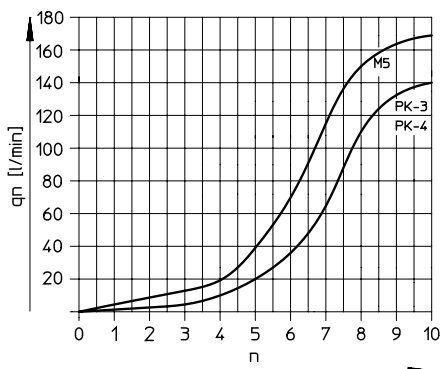

GRLA/GRLZ-1/8

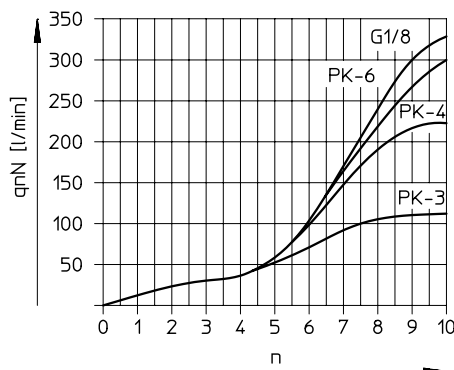

GRLA/GRLZ-1/8

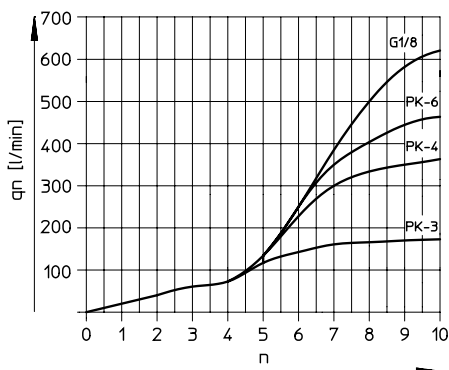

GRLA/GRLZ-1/4

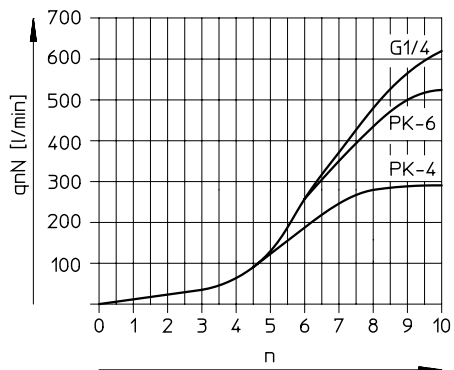

GRLA/GRLZ-1/4

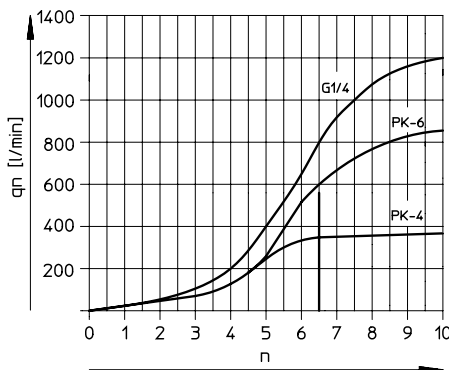

Datasheet – Female thread/barbed connector, metal

Standard nominal flow rate q_{nN} at 6 → 5 bar as a function of spindle rotations n

GRLA-3/8

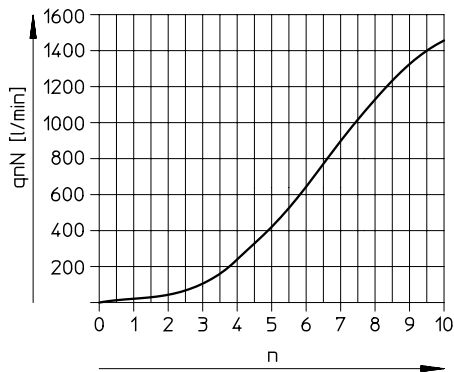

GRLA-1/2

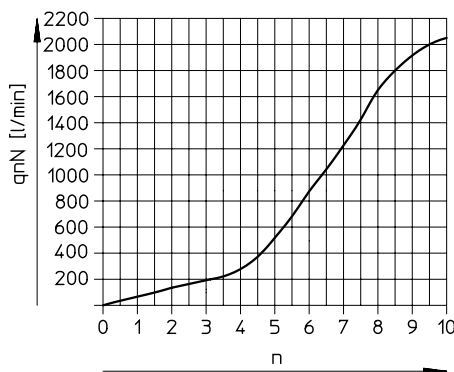

GRLA-3/4

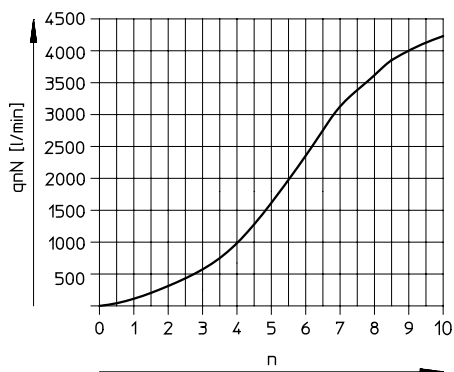

Standard flow rate q_n at 6 → 0 bar as a function of spindle rotations n

GRLA-3/8

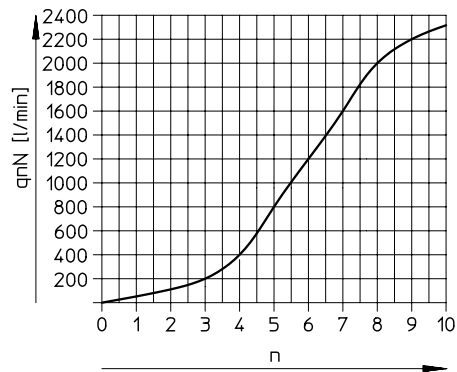

GRLA-1/2

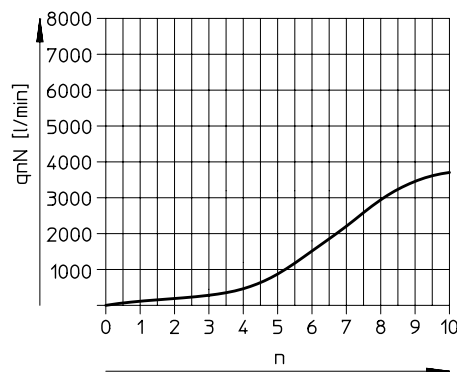

GRLA-3/4

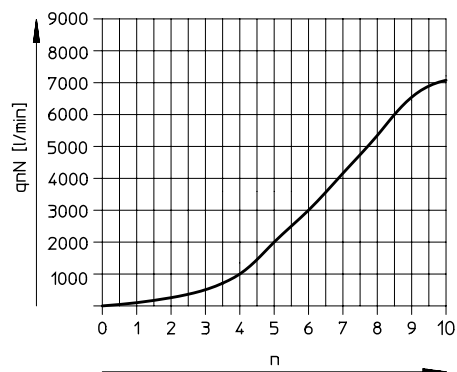

Materials

Sectional view

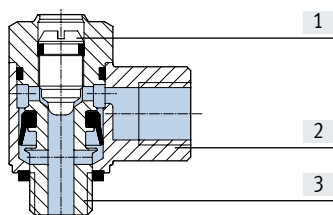

One-way flow control valve	
[1] Adjusting screw	Brass
[2] Swivel connection	Die-cast zinc
[3] Screwed trunnion	Wrought aluminium alloy GRLA/GRLZ-M5: Nickel-plated brass
- Seals	NBR
Note on materials	RoHS-compliant

Datasheet – Female thread/barbed connector, metal

Dimensions – Connection type: Female thread

Download CAD data → www.festo.com

Slotted head screw

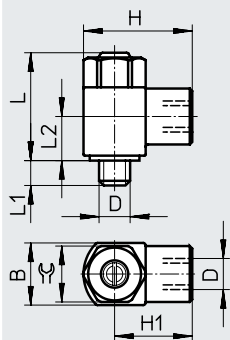

Knurled screw

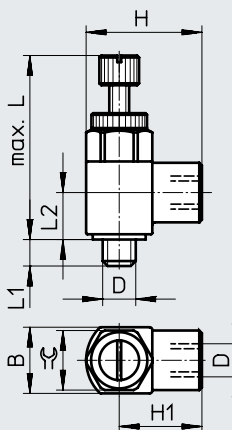

Type	Connection D	Nominal width [mm]	B	~H	~H1	~L		L1	~L2	⊕
						Slotted head screw	Knurled screw			
GRL...-M5	M5	2	10 -0.15	17.5	12.5	18 ±6.2%	28 ±3.4%	4.0 ±0.3	7.1	9
GRL...-1/8	G1/8	4	16 -0.15	28	20	26 ±3.9%	39.4 ±2.1%	5.3 +0.45/-0.35	10.3	14
GRL...-1/4	G1/4	6	20 -0.2	36	26	31.7 ±3.2%	47.4 ±2.0%	8.2 +0.45/-0.35	13.2	17
GRLA-3/8	G3/8	8.5	25 -0.2	41	28.5	38.5 ±2.9%	-	8.8 +0.45/-0.35	15.5	22
GRLA-1/2	G1/2	10.6	32 -0.2	53	37	50 ±2.4%	-	12.8 ±0.45	18.9	27
GRLA-3/4	G3/4	14	41 -0.3	64	43.5	61.8 ±2.2%	-	13.5 ±0.5	24.5	36

† . Note: This product conforms to ISO 1179-1 and ISO 228-1.

Dimensions – Connection type: Barbed connector

Download CAD data → www.festo.com

GRL...-M5

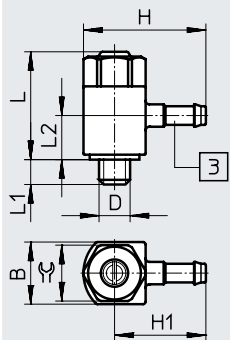

[3] Barbed connector

GRL...-1/8, GRL...-1/4

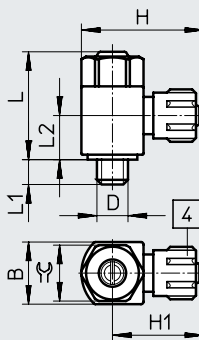

[4] Union nut

Type	Connection D	Nominal width [mm]	B	~H	~H1	~L		L1	~L2	⊕
GRL...-M5-PK-3	M5	2	10 -0.15	19.7	14.7	18	±5.7%	4.0 ±0.3	8.5	9
GRL...-M5-PK-4			10 -0.15	21.7	16.7	18	±5.7%	4.0 ±0.3	8.5	9
GRL...-1/8-PK-3	G1/8	4	16 -0.15	27.1	19.1	26	±3.9%	5.3 +0.45/-0.35	13.4	14
GRL...-1/8-PK-4			16 -0.15	30.2	22.2	26	±3.9%	5.3 +0.45/-0.35	13.4	14
GRL...-1/8-PK-6			16 -0.15	30.3	22.3	26	±3.9%	5.3 +0.45/-0.35	12.0	14
GRL...-1/4-PK-4	G1/4	6	20 -0.2	34.2	24.2	31.7	±3.3%	8.2 +0.45/-0.35	16.9	17
GRL...-1/4-PK-6			20 -0.2	34.3	24.3	31.7	±3.3%	8.2 +0.45/-0.35	17.2	17

Datasheet – Female thread/barbed connector, metal

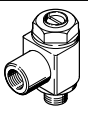
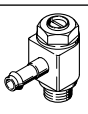
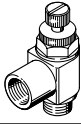
Ordering data – Exhaust air one-way flow control function									
	Pneumatic connection		Standard nominal flow rate qnN at 6 → 5 bar		Standard flow rate qn at 6 → 0 bar		Weight [g]	Part no.	Type
			In flow control direction	In non-return direction	In flow control direction	In non-return direction			
	2	1	[l/min]	[l/min]	[l/min]	[l/min]			
Slotted head screw									
	M5	M5	95	76 ... 95	169	135 ... 170	11	151160	GRLA-M5-B
	G1/8	G1/8	340	260 ... 420	615	470 ... 760	28	151165	GRLA-1/8-B
	G1/4	G1/4	610	450 ... 820	1200	885 ... 1615	59	151172	GRLA-1/4-B
	G3/8	G3/8	1450	970 ... 1600	2300	1540 ... 2540	97	151178	GRLA-3/8-B
	G1/2	G1/2	2100	1550 ... 2200	4000	2950 ... 4190	204	151179	GRLA-1/2-B
	G3/4	G3/4	4320	3220 ... 4720	7300	5440 ... 7300	377	151180	GRLA-3/4-B
	M5	PK-3	83	72 ... 83	140	120 ... 140	10	151161	GRLA-M5-PK-3-B
		PK-4	83	76 ... 88	140	128 ... 148	10	151162	GRLA-M5-PK-4-B
	G1/8	PK-3 ¹⁾	110	100 ... 110	162	145 ... 165	22	151166	GRLA-1/8-PK-3-B
		PK-4 ¹⁾	230	190 ... 240	360	295 ... 375	25	151167	GRLA-1/8-PK-4-B
		PK-6 ¹⁾	300	210 ... 290	455	320 ... 440	26	151168	GRLA-1/8-PK-6-B
	G1/4	PK-4 ¹⁾	260	220 ... 260	370	315 ... 370	44	151173	GRLA-1/4-PK-4-B
PK-6 ¹⁾		540	410 ... 585	840	635 ... 910	45	151174	GRLA-1/4-PK-6-B	
Knurled screw									
	M5	M5	95	76 ... 95	169	135 ... 170	12	151163	GRLA-M5-RS-B
	G1/8	G1/8	340	260 ... 420	615	470 ... 760	30	151169	GRLA-1/8-RS-B
	G1/4	G1/4	610	450 ... 820	1200	885 ... 1615	59	151175	GRLA-1/4-RS-B

1) With union nut

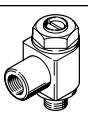
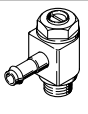
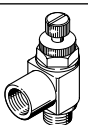

Ordering data – Supply air one-way flow control function									
	Pneumatic connection		Standard nominal flow rate qnN at 6 → 5 bar		Standard flow rate qn at 6 → 0 bar		Weight [g]	Part no.	Type
			In flow control direction	In non-return direction	In flow control direction	In non-return direction			
	2	1	[l/min]	[l/min]	[l/min]	[l/min]			
Slotted head screw									
	M5	M5	95	76 ... 95	169	135 ... 170	11	151183	GRLZ-M5-B
	G1/8	G1/8	340	260 ... 420	615	470 ... 760	28	151188	GRLZ-1/8-B
	G1/4	G1/4	610	450 ... 820	1200	885 ... 1615	59	151195	GRLZ-1/4-B
	M5	PK-3	83	72 ... 83	140	120 ... 140	10	151184	GRLZ-M5-PK-3-B
		PK-4	83	76 ... 88	140	125 ... 150	10	151185	GRLZ-M5-PK-4-B
	G1/8	PK-3 ¹⁾	110	100 ... 110	162	145 ... 165	22	151189	GRLZ-1/8-PK-3-B
		PK-4 ¹⁾	230	190 ... 240	360	295 ... 375	25	151190	GRLZ-1/8-PK-4-B
		PK-6 ¹⁾	300	210 ... 290	455	320 ... 440	26	151191	GRLZ-1/8-PK-6-B
	G1/4	PK-4 ¹⁾	260	220 ... 260	370	315 ... 370	44	151196	GRLZ-1/4-PK-4-B
PK-6 ¹⁾		540	410 ... 585	840	635 ... 910	45	151197	GRLZ-1/4-PK-6-B	
Knurled screw									
	M5	M5	95	76 ... 95	169	135 ... 170	12	151186	GRLZ-M5-RS-B
	G1/8	G1/8	340	260 ... 420	615	470 ... 760	30	151192	GRLZ-1/8-RS-B
	G1/4	G1/4	610	450 ... 820	1200	885 ... 1615	59	151198	GRLZ-1/4-RS-B

1) With union nut

Datasheet – Push-in connector QS, metal

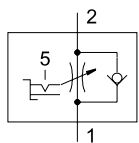
One-way flow control function
Exhaust air



-  - Flow rate
0 ... 450 l/min
-  - Temperature range
-10 ... +60°C
-  - Operating pressure
0.2 ... 10 bar



This one-way flow control valve offers the ideal conditions for optimum and easy setting of the flow rate in a unique design.

There are two setting options:

[1] Gradual for preselection of the flow range in 5 stages via rotary switch:
A, B, C, D, E

[2] Infinitely variable for precision adjustment using internal hex via a scale marked from 0 to 10

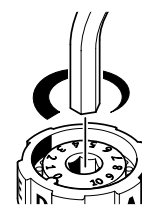
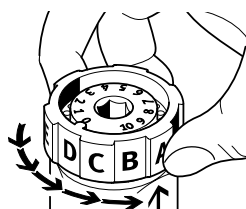
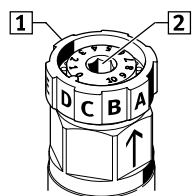

General technical data		
Pneumatic connection 2	G1/8	G1/4
Pneumatic connection 1	QS-6	QS-8
Valve function	Exhaust air one-way flow control function	
Adjusting element	Rotary knob with scale and internal hex	
Actuation type	Manual	
Type of mounting	Screw-in	
Mounting position	Any	
Nominal tightening torque [Nm]	3.5 ±20%	11 ±10%

Operating and environmental conditions		
Operating pressure for full temperature range [bar]	0.2 ... 10	
Operating medium	Compressed air to ISO 8573-1:2010 [7:4:4]	
Note on the operating/pilot medium	Lubricated operation possible (in which case lubricated operation will always be required)	
Ambient temperature [°C]	-10 ... +60	
Temperature of medium [°C]	-10 ... +60	
Storage temperature [°C]	-10 ... +40	

Datasheet – Push-in connector QS, metal

Standard nominal flow rate q_{nN} at 6 → 5 bar as a function of the position of the flow control screw (scale) n

GRLSA-1/8

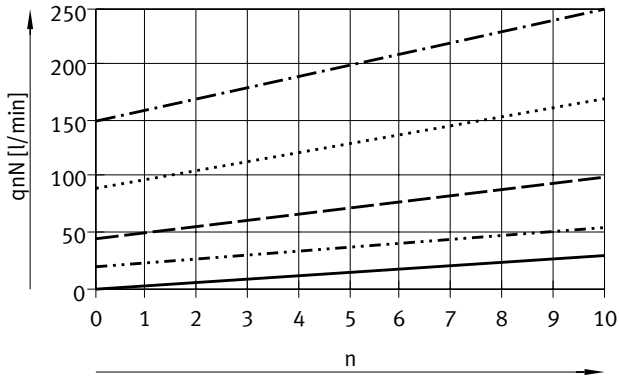

Standard flow rate q_n at 6 → 0 bar as a function of the position of the flow control screw (scale) n

GRLSA-1/8

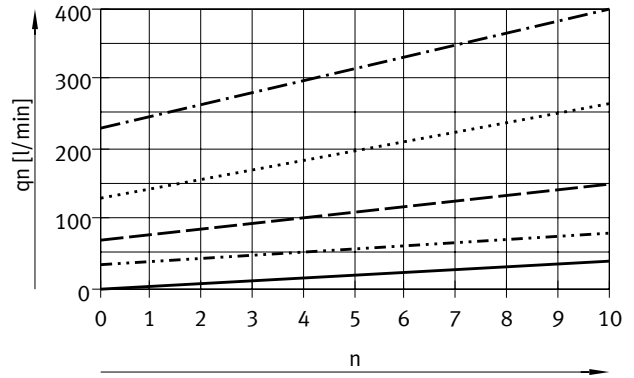

GRLSA-1/4

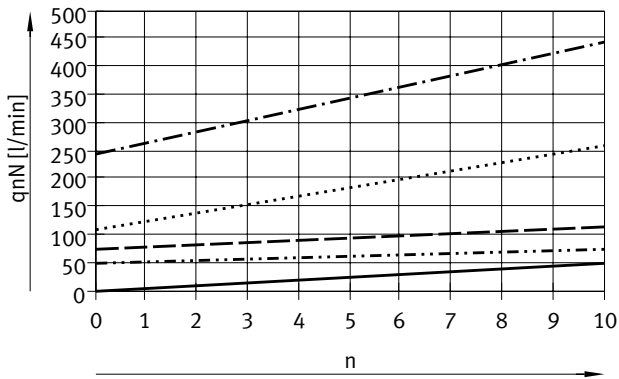

GRLSA-1/4

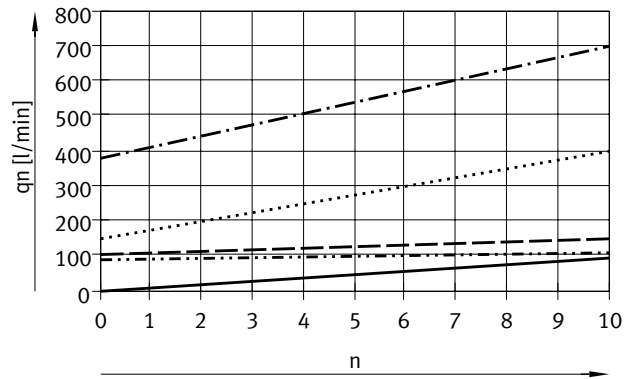

- Stage: A
- · - · Stage: B
- - - Stage: C
- · · · · Stage: D
- · - · - Stage: E

Flow rate value tolerance: ±20%

Materials

Sectional view

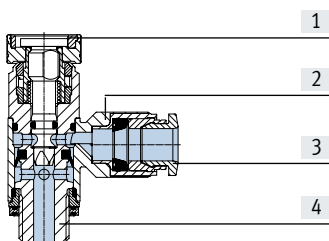

One-way flow control valve	
[1] Adjusting screw	Reinforced PA
[2] Swivel connection	Die-cast zinc
[3] Releasing ring	POM
[4] Hollow bolt	Anodised wrought aluminium alloy
- Seals	NBR
Note on materials	RoHS-compliant
	Free of copper and PTFE

Datasheet – Push-in connector QS, metal

Dimensions

Download CAD data → www.festo.com

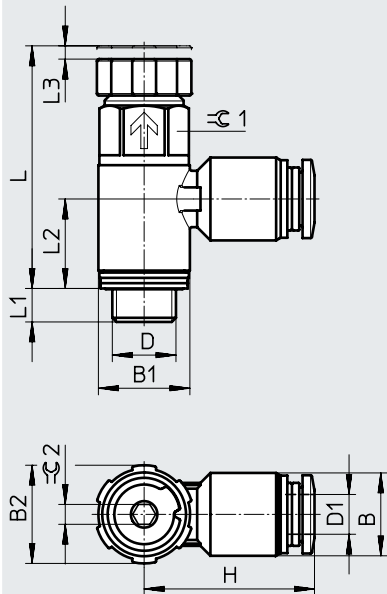





Type	Connection D	Tubing O.D. D1	B	B1	B2	H	L	L1	L2	L3	≈C1	≈C2
GRLSA-1/8	G1/8	6	12.5	13.8	15	25.7	36.6	5.1	13.5	2	12	3
GRLSA-1/4	G1/4	8	14.5	17.8	18.8	30.75	46.5	7	17.2	3	15	3

Ordering data

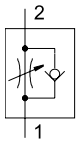
	Pneumatic connection		Standard nominal flow rate qnN at 6 → 5 bar				Weight [g]	Part no.	Type
			In flow control direction		In non-return direction				
			[l/min]	[l/min]	[l/min]	[l/min]			
	2	1							
	G1/8	QS-6	0 ... 250	180 ... 310	0 ... 410	430 ... 540	19.5	540661	GRLSA-1/8-QS-6
	G1/4	QS-8	0 ... 450	390 ... 570	0 ... 700	820 ... 930	34.8	540662	GRLSA-1/4-QS-8

Datasheet – Push-in connector QS, polymer

 One-way flow control function
 Exhaust air

-  Flow rate
520 ... 650 l/min
-  Temperature range
-10 ... +60°C
-  Operating pressure
0.2 ... 10 bar



Can be rotated 360° around the screw-in axis after mounting.

General technical data			
Pneumatic connection 2	G1/8	G1/4	G3/8
Pneumatic connection 1	QS-6, QS-8	QS-6, QS-8	QS-6, QS-8
Valve function	Exhaust air one-way flow control function		
Adjusting element	Knurled screw		
Actuation type	Manual		
Type of mounting	Screw-in		
Mounting position	Any		
Nominal tightening torque [Nm]	3.5 ±20%	11 ±10%	12.5 ±20%
Permissible. actuation torque for adjusting screw [Nm]	0.4		

Operating and environmental conditions	
Operating pressure for full temperature range [bar]	0.2 ... 10
Operating medium	Compressed air to ISO 8573-1:2010 [7:4:4]
Note on the operating/pilot medium	Lubricated operation possible (in which case lubricated operation will always be required)
Ambient temperature [°C]	-10 ... +60
Temperature of medium [°C]	-10 ... +60
Storage temperature [°C]	-10 ... +40
Corrosion resistance class CRC ¹⁾	2

1) Corrosion resistance class CRC 2 to Festo standard FN 940070

Moderate corrosion stress. Indoor applications in which condensation can occur. External visible parts with primarily decorative surface requirements which are in direct contact with a normal industrial environment.

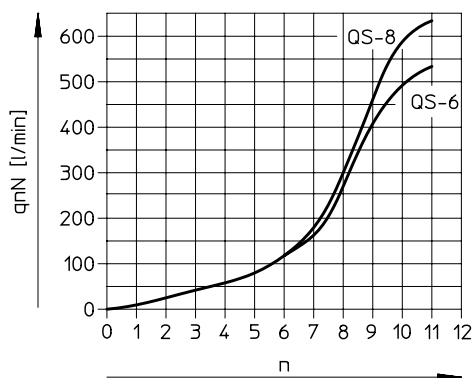
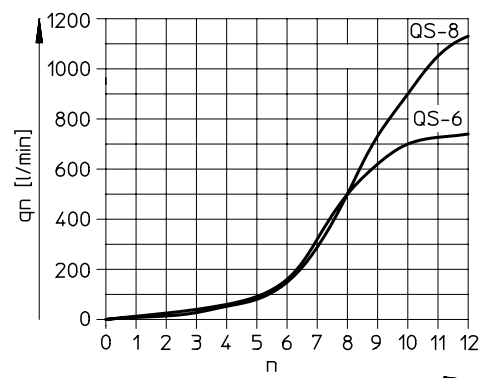
 Standard nominal flow rate q_{nN} at 6 → 5 bar as a function of spindle rotations n

 Standard flow rate q_n at 6 → 0 bar as a function of spindle rotations n

Datasheet – Push-in connector QS, polymer

Materials

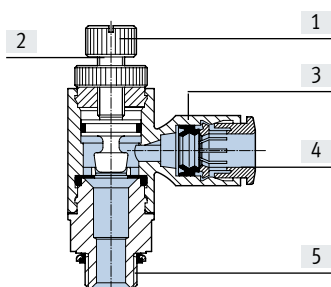
Sectional view



One-way flow control valve

[1]	Knurled head	Wrought aluminium alloy
[2]	Adjusting screw	Brass
[3]	Swivel connection	Reinforced PBT
[4]	Releasing ring	POM
[5]	Screwed trunnion	Wrought aluminium alloy
-	Seals	TPE-U(PU), NBR
Note on materials		RoHS-compliant

Dimensions

Download CAD data → www.festo.com

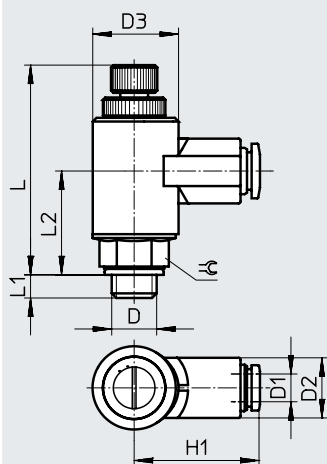





Type	Connection	Tubing O.D.	D2	D3	~H1	~L		~L1	~L2	⊕
	D	D1	∅	∅						
GRLA-1/8	G1/8	6	13.0 ±0.25	17.9 -0.1	27.2	48.1	±2.2%	4.9	22.6	13
		8	16.8 ±0.4		35.4	48	±2.3%			
GRLA-1/4	G1/4	6	13.0 ±0.25	17.9 -0.1	27.2	47.8	±2.3%	5.8	22.3	17
		8	16.8 ±0.4		35.4	47.8	±2.4%			
GRLA-3/8	G3/8	6	13.0 ±0.25	17.9 -0.1	27.2	47.8	±2.3%	6.8	22.3	19
		8	16.8 ±0.4		35.4	47.8	±2.4%			

Ordering data

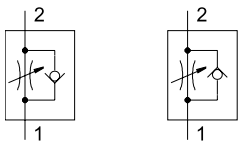
	Pneumatic connection		Standard nominal flow rate qnN at 6 → 5 bar		Standard flow rate qn at 6 → 0 bar		Weight [g]	Part no.	Type
			In flow control direction	In non-return direction	In flow control direction	In non-return direction			
	2	1	[l/min]	[l/min]	[l/min]	[l/min]			
	G1/8	QS-6	520	400 ... 550	720	600 ... 750	25	162965	GRLA-1/8-QS-6-RS-B
		QS-8	650	600 ... 750	1080	800 ... 1250		162966	GRLA-1/8-QS-8-RS-B
	G1/4	QS-6	520	400 ... 550	720	600 ... 750	30	162967	GRLA-1/4-QS-6-RS-B
		QS-8	650	600 ... 750	1130	800 ... 1250		162968	GRLA-1/4-QS-8-RS-B
	G3/8	QS-6	530	400 ... 550	720	600 ... 750	40	162969	GRLA-3/8-QS-6-RS-B
		QS-8	650	600 ... 750	1130	800 ... 1250		162970	GRLA-3/8-QS-8-RS-B

Datasheet – Push-in connector QS, metal

 One-way flow control function
 Exhaust air Supply air

 Low flow: precise adjustment
 for low speed

-  - Flow rate
40 ... 48 l/min
-  - Temperature range
-10 ... +60°C
-  - Operating pressure
0.2 ... 10 bar



General technical data – GRLA		
Pneumatic connection 2	M3	M5
Pneumatic connection 1	QS-3	QS-3, QS-4
Valve function	Exhaust air one-way flow control function	
Adjusting element	Slotted head screw	
Type of mounting	Screw-in	
Mounting position	Any	
Max. tightening torque [Nm]	0.3	1.5

General technical data – GRLZ		
Pneumatic connection 2	M3	M5
Pneumatic connection 1	QS-3	QS-3, QS-4
Valve function	Supply air one-way flow control function	
Adjusting element	Slotted head screw	
Type of mounting	Screw-in	
Mounting position	Any	
Max. tightening torque [Nm]	0.3	1.5

Operating and environmental conditions		
Operating pressure [bar]	0.2 ... 10	
Operating medium	Compressed air to ISO 8573-1:2010 [7:4:4]	
Note on the operating/pilot medium	Lubricated operation possible (in which case lubricated operation will always be required)	
Ambient temperature [°C]	-10 ... +60	
Temperature of medium [°C]	-10 ... +60	
Storage temperature [°C]	-10 ... +40	
Certification	GRLA: Germanischer Lloyd	

Datasheet – Push-in connector QS, metal

Standard nominal flow rate q_{nN} at 6 → 5 bar as a function of spindle rotations n

GRLA/GRLZ-M3

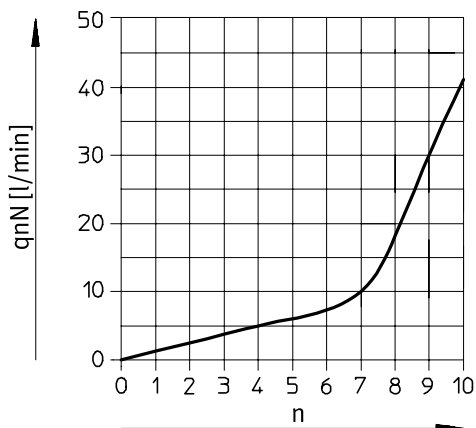

Standard flow rate q_n at 6 → 0 bar as a function of spindle rotations n

GRLA/GRLZ-M3

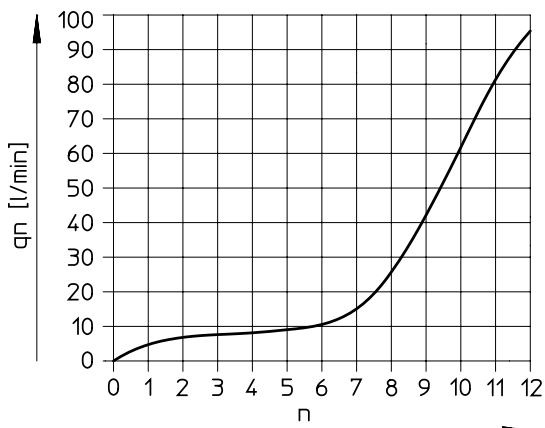

GRLA/GRLZ-M5

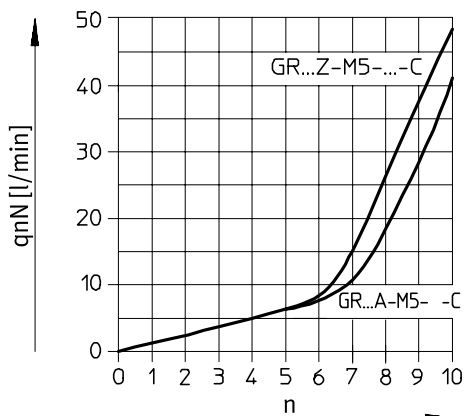

GRLA/GRLZ-M5

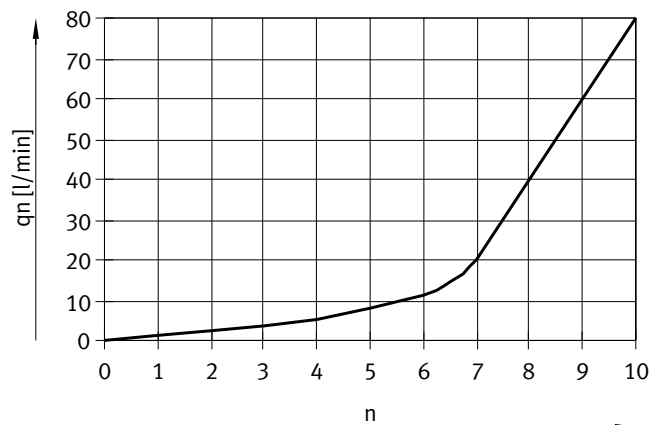

Materials

Sectional view

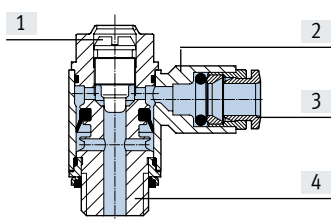

One-way flow control valve

[1]	Adjusting screw	Brass
[2]	Swivel connection	Die-cast zinc
[3]	Releasing ring	POM
[4]	Screwed trunnion	Brass, nickel-plated
-	Seals	NBR
Note on materials		RoHS-compliant

Datasheet – Push-in connector QS, metal

Dimensions

Download CAD data → www.festo.com

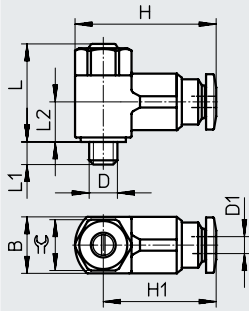

Type	Connection D	Nominal width [mm]	Tubing O.D. D1	B	~H	~H1	~L	L1	~L2	≙
GRLA/GRLZ	M3	1.4	3	8 -0.15	20	15.8	16.6 ±3.3%	2.3 +0.15/-0.3	7	7
	M5	1.4	3	9.8 -0.15	22.4	18.4	17.2 ±3.1%	3.1 +0.15/-0.35	7.3	
		1.4	4	9.8 -0.15	22.2	18.2	17.2 ±3.1%	3.1 +0.15/-0.35	7.3	

Ordering data

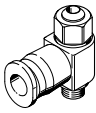
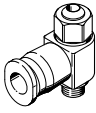
Pneumatic connection	Standard nominal flow rate qnN at 6 → 5 bar		Standard flow rate qn at 6 → 0 bar		Weight [g]	Part no.	Type		
	In flow control direction	In non-return direction	In flow control direction	In non-return direction					
2	1	[l/min]	[l/min]	[l/min]	[l/min]	[g]			
Exhaust air one-way flow control function									
	M3	QS-3	41	27 ... 50	95	75 ... 110	7	175041	GRLA-M3-QS-3
	M5	QS-3	40	46 ... 70	80	90 ... 140	9	175053	GRLA-M5-QS-3-LF-C
		QS-4	40	50 ... 75	80	100 ... 150	9	175056	GRLA-M5-QS-4-LF-C
Supply air one-way flow control function									
	M3	QS-3	41	27 ... 44	95	75 ... 100	7	175043	GRLZ-M3-QS-3
	M5	QS-3	48	36 ... 52	80	60 ... 90	9	175055	GRLZ-M5-QS-3-LF-C
		QS-4	48	40 ... 65	80	65 ... 110	9	175058	GRLZ-M5-QS-4-LF-C



Datasheet – Female thread, metal

One-way flow control function

Exhaust air

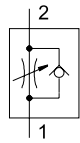
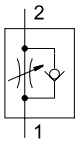
Supply air



-  - Flow rate
0 ... 18 l/min
-  - Temperature range
-10 ... +60°C
-  - Operating pressure
0.2 ... 10 bar



General technical data – GRLA

Pneumatic connection 2	M3
Pneumatic connection 1	M3
Valve function	Exhaust air one-way flow control function
Adjusting element	Slotted head screw
Type of mounting	Screw-in
Mounting position	Any
Max. tightening torque [Nm]	0.3

General technical data – GRLZ

Pneumatic connection 2	M3
Pneumatic connection 1	M3
Valve function	Supply air one-way flow control function
Adjusting element	Slotted head screw
Type of mounting	Screw-in
Mounting position	Any
Max. tightening torque [Nm]	0.3

Operating and environmental conditions

Operating pressure [bar]	0.2 ... 10
Operating medium	Compressed air to ISO 8573-1:2010 [7:4:4]
Note on the operating/pilot medium	Lubricated operation possible (in which case lubricated operation will always be required)
Ambient temperature [°C]	-10 ... +60
Temperature of medium [°C]	-10 ... +60
Storage temperature [°C]	-10 ... +40
Certification	GRLA: Germanischer Lloyd

Standard nominal flow rate q_{nN} at 6 → 5 bar as a function of spindle rotations n

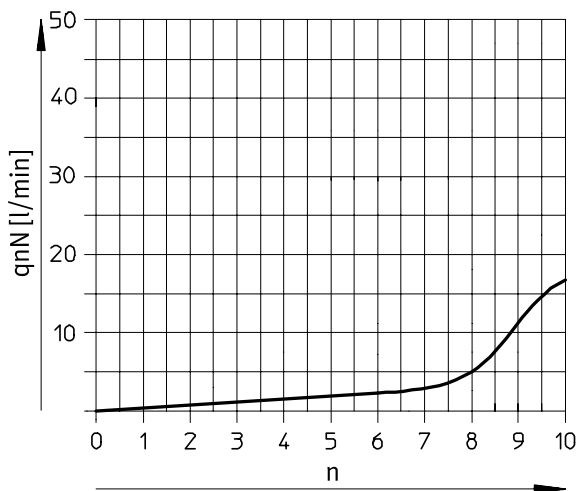

Standard flow rate q_n at 6 → 0 bar as a function of spindle rotations n

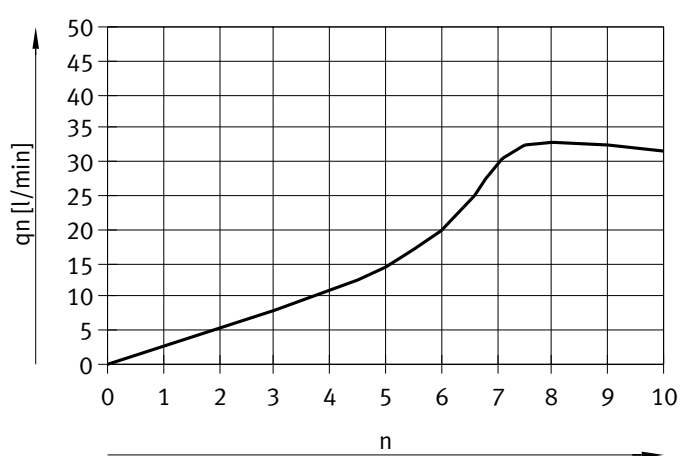

Datasheet – Female thread, metal

Materials

Sectional view

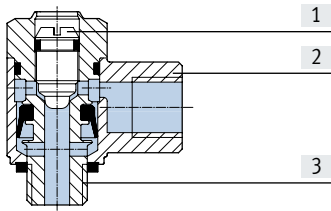

One-way flow control valve	
[1] Adjusting screw	Brass
[2] Swivel connection	Die-cast zinc
[3] Screwed trunnion	Brass, nickel-plated
- Seals	NBR
Note on materials	RoHS-compliant

Dimensions

Download CAD data → www.festo.com

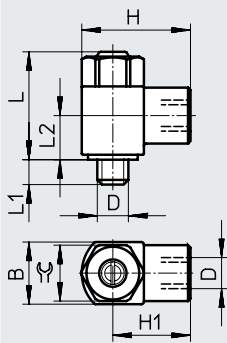

Type	Connection D	Nominal width [mm]	B	~H	~H1	~L	L1	~L2	⊖
GRLA/GRLZ	M3	0.8	5 -0.1	9	6.5	13.4 ±3.9%	2.5 +0.15/-0.3	6.4	4.5



Ordering data

	Pneumatic connection		Standard nominal flow rate qnN at 6 → 5 bar		Standard flow rate qn at 6 → 0 bar		Weight [g]	Part no.	Type
	2	1	In flow control direction [l/min]	In non-return direction [l/min]	In flow control direction [l/min]	In non-return direction [l/min]			
Exhaust air one-way flow control function									
	M3	M3	18	18 ... 20	33	33 ... 37	2	175038	GRLA-M3
Supply air one-way flow control function									
	M3	M3	18	18 ... 20	33	33 ... 37	2	175040	GRLZ-M3

Datasheet – Female thread, stainless steel

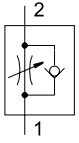
One-way flow control function
Exhaust air



-  - Flow rate
95 ... 2100 l/min
-  - Temperature range
-20 ... +80°C
-  - Operating pressure
0.3 ... 10 bar



General technical data						
Pneumatic connection 2	M5	G1/8	G1/4	G3/8	G1/2	
Pneumatic connection 1	M5	G1/8	G1/4	G3/8	G1/2	
Valve function	Exhaust air one-way flow control function					
Adjusting element	Slotted head screw					
Type of mounting	Screw-in					
Mounting position	Any					
Max. tightening torque [Nm]	1.5	6	11	20	40	
Permissible actuation torque, adjusting screw [Nm]	0.2	0.5	1.5	2	3	

↓ Note: This product conforms to ISO 1179-1 and ISO 228-1.

Operating and environmental conditions						
Pneumatic connection 2	M5	G1/8	G1/4	G3/8	G1/2	
Operating pressure [bar]	0.2 ... 10		0.3 ... 10			
Operating medium	Compressed air to ISO 8573-1:2010 [7:4:4]					
Note on the operating/pilot medium	Lubricated operation possible (in which case lubricated operation will always be required)					
Ambient temperature [°C]	-20 ... +80					
Temperature of medium [°C]	-10 ... +60					
Storage temperature [°C]	-10 ... +40					
Corrosion resistance class CRC ¹⁾	3					
Food-safe	See supplementary material information ²⁾					
Maritime classification	See certificate ²⁾					

1) Corrosion resistance class CRC 3 to Festo standard FN 940070

High corrosion stress. Outdoor exposure under moderate corrosive conditions. Externally visible parts with primarily functional surface requirements which are in direct contact with a normal industrial environment.

2) Additional information: www.festo.com/catalogue/... → Support/Downloads.

Standard nominal flow rate q_{nN} at 6 → 5 bar as a function of spindle rotations n

CRGRLA-M5, CRGRLA-1/8

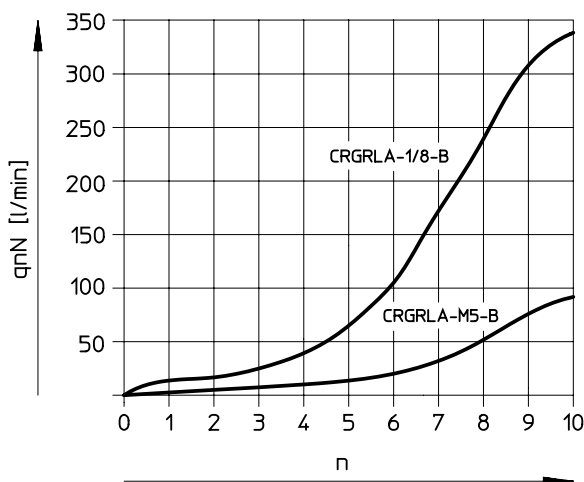

Standard flow rate q_n at 6 → 0 bar as a function of spindle rotations n

CRGRLA-M5, CRGRLA-1/8

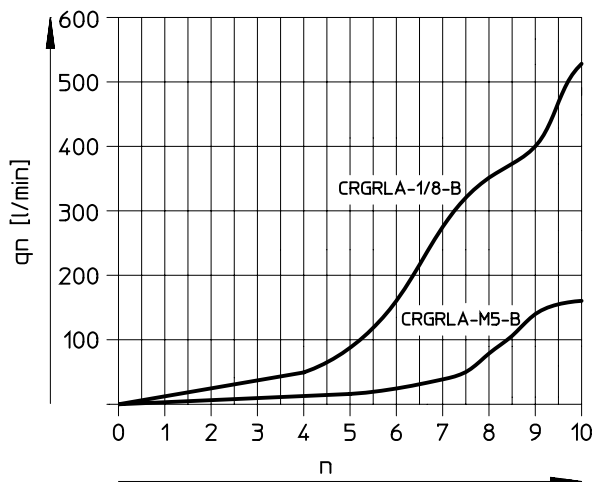

Datasheet – Female thread, stainless steel

Standard nominal flow rate q_{nN} at 6 → 5 bar as a function of spindle rotations n

CRGRLA-1/4, CRGRLA-3/8, CRGRLA-1/2

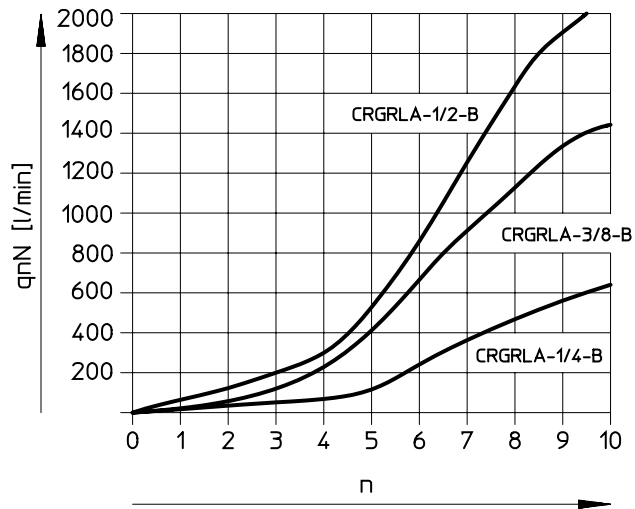

Standard flow rate q_n at 6 → 0 bar as a function of spindle rotations n

CRGRLA-1/4, CRGRLA-3/8, CRGRLA-1/2

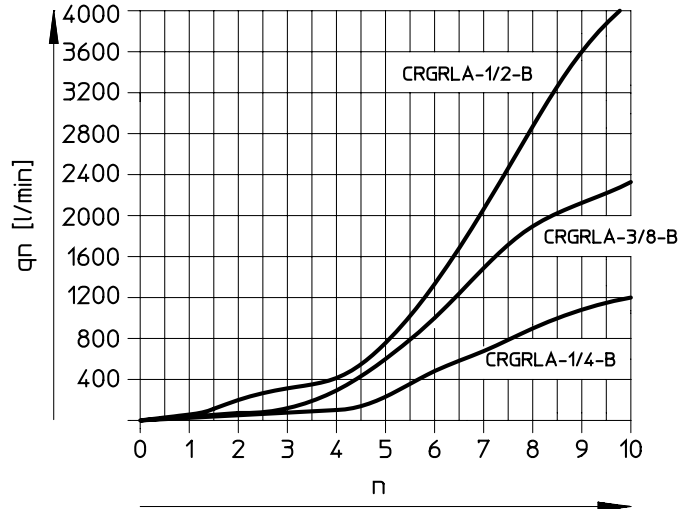

Materials

Sectional view

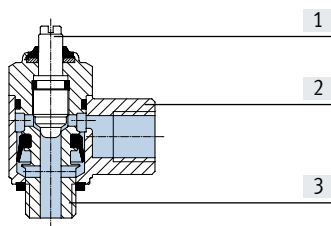

One-way flow control valve	
[1] Adjusting screw	High-alloy stainless steel
[2] Swivel connection	High-alloy stainless steel
[3] Hollow bolt	High-alloy steel
- Seals	FPM, PVC
Note on materials	RoHS-compliant

Datasheet – Female thread, stainless steel

Dimensions

Download CAD data → www.festo.com

CRGRLA-M5

CRGRLA-1/8, CRGRLA-1/4, CRGRLA-3/8, CRGRLA-1/2

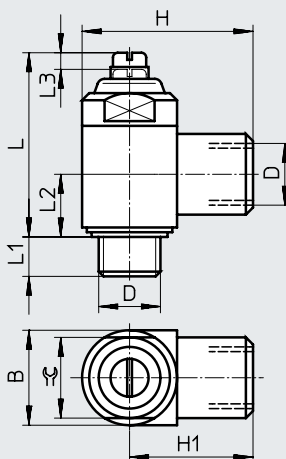
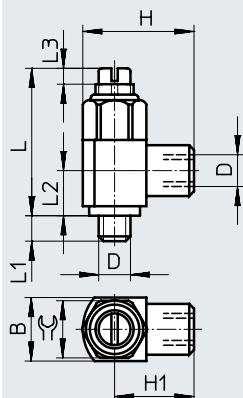

Type	Connection D	Nominal width [mm]	B	H	H1	~L	~L1	~L2	~L3	⊕
CRGRLA-M5	M5	2	10 -0.25	17.5 ±0.3	12.5	22.9 ±3.5%	4	7.1	2.5	9
CRGRLA-1/8	G1/8	4	16 -0.4	28 +0.4/-0.3	20	33.8 ±2.7%	5.5	10.3	3.5	14
CRGRLA-1/4	G1/4	6	20 -0.3	36 +0.4/-0.2	26	38.8 ±2.7%	6.5	13.2	3.5	17
CRGRLA-3/8	G3/8	8.5	25 -0.3	41 +0.4/-0.2	28.5	48.5 ±2.2%	7.5	15.4	5	22
CRGRLA-1/2	G1/2	10.6	32 -0.4	53 ±0.5	37	62.2 ±1.7%	9	18.9	7.5	27

† Note: This product conforms to ISO 1179-1 and ISO 228-1.

Ordering data

	Pneumatic connection		Standard nominal flow rate qnN at 6 → 5 bar		Standard flow rate qn at 6 → 0 bar		Weight [g]	Part no.	Type
			In flow control direction	In non-return direction	In flow control direction	In non-return direction			
	2	1	[l/min]	[l/min]	[l/min]	[l/min]			
	M5	M5	95	77 ... 95	165	140 ... 150	10.2	161403	CRGRLA-M5-B
	G1/8	G1/8	340	260 ... 420	580	530 ... 590	37.8	161404	CRGRLA-1/8-B
	G1/4	G1/4	610	450 ... 820	1265	1030 ... 1345	71.6	161405	CRGRLA-1/4-B
	G3/8	G3/8	1450	970 ... 1600	2515	2095 ... 2665	126.9	161406	CRGRLA-3/8-B
	G1/2	G1/2	2100	1550 ... 2200	4265	3550 ... 4325	262.3	161407	CRGRLA-1/2-B