

Branching modules/distributor blocks MS-FRM, MS series

FESTO

Festo Core Range
Solves the majority of your automation tasks

Worldwide: Quickest delivery – wherever, whenever
Simply good: Expected high Festo quality
Fast: Easy and fast to select

With the Festo Core Range, we have selected the most important products and functions from our broad product catalogue, and added the quickest delivery.

The Core Range offers you the best value for your automation tasks.

Just look
for the
star!

Key features

MS series service unit components

Solutions for every application

With its large product range, highly effective components and a wide choice of functions, the MS series from Festo offers a complete concept for compressed air preparation. It is suitable for simple standard applications as well as application-specific solutions with very high quality requirements. Available as individual components, pre-assembled combinations ex-stock,

application-specific combinations or complete turnkey solutions. The five sizes in the MS series achieve maximum flow rates with low space requirements.

Freely combinable function modules

Pressure regulators, on/off and soft-start valves with safety function, filters, pressure and flow sensors, dryers, sensors and lubricators can be assembled into a suitable solution for every task. With the modular structure the components can be combined as required. The simple connection system saves time because replacing

individual modules does not require disassembling the entire combination. Many of the components are also UL and ATEX certified.

CAD models and configurator

Convenient tools for planning and selecting application-specific individual components and combinations. The product configurator lets you configure customised solutions quickly and transfer the order data without any hassle.

Engineering tools

Selection tool for choosing the right service unit combination without oversizing, and with the right air quality class:

→ www.festo.com/engineering/wartungseinheit



Integrated sensors

Pressure and flow sensors

Safety functions

Soft-start/quick exhaust valves
MS6-SV/MS9-SV

Energy savings

Service unit combinations MSE6

Intelligent mix of sizes



- Maximum machine availability by controlled processes
- Reliable compressed air preparation and supply for systems
- Integrated or stand-alone
- Easy to connect with M8/M12 plug



- Fast and reliable exhausting of systems up to Performance Level e, certified to EN ISO 13849-1
- Integrated soft-start function



- Fully automatic monitoring and regulation of compressed air supply
- Automatic shut-off of the compressed air in stand-by mode
- Detection and notification of leakages
- Condition monitoring of relevant process data



- Optimum flow rate with a size that is up to 18% smaller
- Excellent energy efficiency
- Cost-optimised combinations – save up to 30%!

Size differences

Size	MS2	MS4	MS6	MS9	MS12
Grid dimension [mm]	25	40	62	90	124
Connection sizes	M5, QS-6	G1/8, G1/4, G3/8	G1/4, G3/8, G1/2, G3/4	G1/2, G3/4, G1, G1 1/4, G1 1/2	G1, G1 1/4, G1 1/2, G2
Standard nominal flow rate $q_{nN}^{1)}$ [l/min]	350	1800	6500	20000	22000

1) Using pressure regulator MS-LR as an example

Key features

Note

Information

The next few pages provide a brief overview of the product range for the MS series service unit components.

You can find detailed information and all the technical data in the documentation for the corresponding service unit component.

Accessories such as connecting plates or mounting brackets can be ordered either via the configurator or separately.





Design of a service unit

The sequence of the individual components within a service unit is relevant for safety and functionality. The service unit components cannot be combined in any order in the flow direction. They are subject to restrictions and rules.





The configurator for the service unit MSB is a reliable and convenient way of combining the individual service unit components and it ensures compliance with the applicable rules. As a result, you get a fully assembled unit, including UL or ATEX certification, if necessary.
When combining a unit from individually configured and ordered service unit components, the points on the right must be adhered to under all circumstances.

- Regulators MS-LFR/LR/LRP/LRE are only permissible in the flow direction with the same or decreasing pressure regulation range
- Filters MS-LFR/LF/LFM/LFX are only permissible in the flow direction with an increasing grade of filtration
- Lubricators MS-LOE are not permitted in the flow direction upstream of a filter MS-LFR/LFM/LF/LFX, water separator MS-LWS or membrane air dryer MS-LDM1
- A micro filter MS-LFM must be installed in the flow direction upstream of an activated carbon filter MS-LFX or membrane air dryer MS-LDM1
- A flow sensor SFAM cannot be installed directly downstream of a regulator MS-LFR/LR; a branching module MS-FRM must be positioned between them
- A soft-start/quick exhaust valve MS-SV must be the last service unit component in the flow direction







Total product range for MS series service unit components

Type	Description	Size	Pneumatic connection					
			Push-in connector	Female thread			Connecting plate with thread	
				M	G	NPT	G	NPT
Combinations								
Service unit combinations MSB-FRC								Datasheets → Internet: msb
	Combinations of filter regulator and lubricator	4	–	–	1/8, 1/4	–	–	–
		6	–	–	1/4, 3/8, 1/2	–	–	–
Service unit combinations MSB								
Service unit combinations MSB								Datasheets → Internet: msb
	7 combinations, predefined	4	–	–	1/4	–	–	–
		6	–	–	1/2	–	–	–
	Freely configurable combinations	4	–	–	1/8, 1/4	–	1/8, 1/4, 3/8	1/8, 1/4, 3/8
		6	–	–	1/4, 3/8, 1/2	–	1/4, 3/8, 1/2, 3/4	1/4, 3/8, 1/2, 3/4
		9	–	–	3/4, 1	3/4, 1	1/2, 3/4, 1, 1 1/4, 1 1/2	1/2, 3/4, 1, 1 1/4, 1 1/2
Service unit combinations MSE6								
Service unit combinations MSE6								Datasheets → Internet: mse6
	Combinations with fieldbus connection for measuring pressure, flow rate and consumption	6	–	–	–	–	1/2	–





Key features

Total product range for MS series service unit components								
Type	Description	Size	Pneumatic connection			Connecting plate with thread		
			Push-in connector	Female thread		Connecting plate with thread		
			M	G	NPT	G	NPT	
Individual devices								
Filter regulators MS-LFR								Datasheets → Internet: ms-lfr
	Filter and pressure regulator in a single device, grade of filtration 5 or 40 µm	2	QS-6	M5	–	–	–	–
		4	–	–	1/8, 1/4	–	1/8, 1/4, 3/8	1/8, 1/4, 3/8
		6	–	–	1/4, 3/8, 1/2	–	1/4, 3/8, 1/2, 3/4	1/4, 3/8, 1/2, 3/4
		9	–	–	3/4, 1	3/4, 1	1/2, 3/4, 1, 1 1/4, 1 1/2	1/2, 3/4, 1, 1 1/4, 1 1/2
		12	–	–	–	–	1, 1 1/4, 1 1/2, 2	–
Filter MS-LF								
								Datasheets → Internet: ms-lf
	Grade of filtration 5 or 40 µm	4	–	–	1/8, 1/4	–	1/8, 1/4, 3/8	1/8, 1/4, 3/8
		6	–	–	1/4, 3/8, 1/2	–	1/4, 3/8, 1/2, 3/4	1/4, 3/8, 1/2, 3/4
		9	–	–	3/4, 1	3/4, 1	1/2, 3/4, 1, 1 1/4, 1 1/2	1/2, 3/4, 1, 1 1/4, 1 1/2
		12	–	–	–	–	1, 1 1/4, 1 1/2, 2	–
Fine and micro filters MS-LFM								
								Datasheets → Internet: ms-lfm
	Grade of filtration 0.01 or 1 µm	4	–	–	1/8, 1/4	–	1/8, 1/4, 3/8	1/8, 1/4, 3/8
		6	–	–	1/4, 3/8, 1/2	–	1/4, 3/8, 1/2, 3/4	1/4, 3/8, 1/2, 3/4
		9	–	–	3/4, 1	3/4, 1	1/2, 3/4, 1, 1 1/4, 1 1/2	1/2, 3/4, 1, 1 1/4, 1 1/2
		12	–	–	–	–	1, 1 1/4, 1 1/2, 2	–
Activated carbon filters MS-LFX								
								Datasheets → Internet: ms-lfx
	For removing liquid and gaseous oil particles	4	–	–	1/8, 1/4	–	1/8, 1/4, 3/8	1/8, 1/4, 3/8
		6	–	–	1/4, 3/8, 1/2	–	1/4, 3/8, 1/2, 3/4	1/4, 3/8, 1/2, 3/4
		9	–	–	3/4, 1	3/4, 1	1/2, 3/4, 1, 1 1/4, 1 1/2	1/2, 3/4, 1, 1 1/4, 1 1/2
		12	–	–	–	–	1, 1 1/4, 1 1/2, 2	–
Water separators MS-LWS								
								Datasheets → Internet: ms-lws
	Removes condensate from compressed air, maintenance-free	6	–	–	1/4, 3/8, 1/2	–	1/4, 3/8, 1/2, 3/4	1/4, 3/8, 1/2, 3/4
		9	–	–	3/4, 1	3/4, 1	1/2, 3/4, 1, 1 1/4, 1 1/2	1/2, 3/4, 1, 1 1/4, 1 1/2
		12	–	–	–	–	1, 1 1/4, 1 1/2, 2	–





Key features

Total product range for MS series service unit components								
Type	Description	Size	Pneumatic connection			Connecting plate with thread		
			Push-in connector	Female thread		G		NPT
			M	G	NPT	G		NPT
Individual devices								
Pressure regulators MS-LR								Datasheets → Internet: ms-lr
	For setting the required operating pressure, 4 pressure regulation ranges	2	QS-6	M5	–	–	–	–
		4	–	–	1/8, 1/4	–	1/8, 1/4, 3/8	1/8, 1/4, 3/8
		6	–	–	1/4, 3/8, 1/2	–	1/4, 3/8, 1/2, 3/4	1/4, 3/8, 1/2, 3/4
		9	–	–	3/4, 1	3/4, 1	1/2, 3/4, 1, 1 1/4, 1 1/2	1/2, 3/4, 1, 1 1/4, 1 1/2
		12	–	–	–	–	1, 1 1/4, 1 1/2, 2	–
Pressure regulators MS-LRB								Datasheets → Internet: ms-lrb
	For configuring a regulator manifold with independent pressure regulation ranges. Pressure output is to the front or rear.	4	–	–	1/4	–	1/8, 1/4, 3/8	–
		6	–	–	1/2	–	1/4, 3/8, 1/2, 3/4	–
Precision pressure regulators MS-LRP								Datasheets → Internet: ms-lrp
	For precise setting of the required operating pressure, 4 pressure regulation ranges, pressure hysteresis 0.02 bar	6	–	–	1/4, 3/8, 1/2	–	1/4, 3/8, 1/2, 3/4	1/4, 3/8, 1/2, 3/4
Precision pressure regulators MS-LRPB								Datasheets → Internet: ms-lrpb
	For configuring a regulator manifold with independent pressure regulation ranges. Pressure output is to the front or rear.	6	–	–	1/2	–	1/4, 3/8, 1/2, 3/4	–
Electric pressure regulators MS-LRE								Datasheets → Internet: ms-lre
	Electrically adjustable pressure regulator, 4 pressure regulation ranges	6	–	–	1/4, 3/8, 1/2	–	1/4, 3/8, 1/2, 3/4	1/4, 3/8, 1/2, 3/4
Lubricators MS-LOE								Datasheets → Internet: ms-loe
	Add a precisely adjustable amount of oil to the compressed air. The amount of oil mist is proportional to the compressed air flow rate.	4	–	–	1/8, 1/4	–	1/8, 1/4, 3/8	1/8, 1/4, 3/8
		6	–	–	1/4, 3/8, 1/2	–	1/4, 3/8, 1/2, 3/4	1/4, 3/8, 1/2, 3/4
		9	–	–	3/4, 1	3/4, 1	1/2, 3/4, 1, 1 1/4, 1 1/2	1/2, 3/4, 1, 1 1/4, 1 1/2
		12	–	–	–	–	1, 1 1/4, 1 1/2, 2	–

Key features

Total product range for MS series service unit components								
Type	Description	Size	Pneumatic connection			Connecting plate with thread		
			Push-in connector	Female thread		G		NPT
			M	G	NPT	G	NPT	
Individual devices								
On/off valves MS-EM							Datasheets → Internet: ms-em	
	Manually actuated on/off valve for pressurising and exhausting pneumatic installations.	4	–	–	1/8, 1/4	–	1/8, 1/4, 3/8	1/8, 1/4, 3/8
		6	–	–	1/4, 3/8, 1/2	–	1/4, 3/8, 1/2, 3/4	1/4, 3/8, 1/2, 3/4
		9	–	–	3/4, 1	3/4, 1	1/2, 3/4, 1, 1 1/4, 1 1/2	1/2, 3/4, 1, 1 1/4, 1 1/2
		12	–	–	–	–	1, 1 1/4, 1 1/2, 2	–
On/off valves MS-EE								
On/off valves MS-EE							Datasheets → Internet: ms-ee	
	Electrically actuated on/off valve for pressurising and exhausting pneumatic installations.	4	–	–	1/8, 1/4	–	1/8, 1/4, 3/8	1/8, 1/4, 3/8
		6	–	–	1/4, 3/8, 1/2	–	1/4, 3/8, 1/2, 3/4	1/4, 3/8, 1/2, 3/4
		9	–	–	3/4, 1	3/4, 1	1/2, 3/4, 1, 1 1/4, 1 1/2	1/2, 3/4, 1, 1 1/4, 1 1/2
		12	–	–	–	–	1, 1 1/4, 1 1/2, 2	–
Soft-start valves MS-DL								
Soft-start valves MS-DL							Datasheets → Internet: ms-dl	
	Pneumatically actuated soft-start valve for slow pressurisation and exhaust of pneumatic installations.	4	–	–	1/8, 1/4	–	1/8, 1/4, 3/8	1/8, 1/4, 3/8
		6	–	–	1/4, 3/8, 1/2	–	1/4, 3/8, 1/2, 3/4	1/4, 3/8, 1/2, 3/4
		12	–	–	–	–	1, 1 1/4, 1 1/2, 2	–
Soft-start valves MS-DE								
Soft-start valves MS-DE							Datasheets → Internet: ms-de	
	Electrically actuated soft-start valve for slow pressurisation and exhaust of pneumatic installations.	4	–	–	1/8, 1/4	–	1/8, 1/4, 3/8	1/8, 1/4, 3/8
		6	–	–	1/4, 3/8, 1/2	–	1/4, 3/8, 1/2, 3/4	1/4, 3/8, 1/2, 3/4
		12	–	–	–	–	1, 1 1/4, 1 1/2, 2	–
Soft-start/quick exhaust valves MS-SV								
Soft-start/quick exhaust valves MS-SV							Datasheets → Internet: ms-sv	
	For gradually increasing pressurisation and quick, safe pressure reduction in pneumatic piping systems. Up to category 1, PL c.	6	–	–	1/2	–	1/4, 3/8, 1/2, 3/4	1/4, 3/8, 1/2, 3/4
		9	–	–	3/4, 1	3/4, 1	1/2, 3/4, 1, 1 1/4, 1 1/2	1/2, 3/4, 1, 1 1/4, 1 1/2
	Up to category 3, PL d. Up to category 4, PL e in the case of optional extension.	6	–	–	1/2	–	1/4, 3/8, 1/2, 3/4	1/4, 3/8, 1/2, 3/4
	Up to category 4, PL e.	6	–	–	1/2	–	1/4, 3/8, 1/2, 3/4	–

Key features

Total product range for MS series service unit components								
Type	Description	Size	Pneumatic connection					
			Push-in connector	Female thread			Connecting plate with thread	
				M	G	NPT	G	NPT
Individual devices								
Membrane air dryers MS-LDM1								Datasheets → Internet: ms-ldm
	Wear-free membrane dryer with internal air consumption	4	–	–	1/8, 1/4	–	1/8, 1/4, 3/8	1/8, 1/4, 3/8
		6	–	–	1/4, 3/8, 1/2	–	1/4, 3/8, 1/2, 3/4	1/4, 3/8, 1/2, 3/4
Branching modules MS-FRM								
Compressed air distributors with 4 connections								Datasheets → Internet: ms-frm
	Compressed air distributors with 4 connections	4	–	–	1/8, 1/4	–	1/8, 1/4, 3/8	–
		6	–	–	1/4, 3/8, 1/2	–	1/4, 3/8, 1/2, 3/4	–
		9	–	–	3/4, 1	3/4, 1	1/2, 3/4, 1, 1 1/4, 1 1/2	1/2, 3/4, 1, 1 1/4, 1 1/2
		12	–	–	–	–	1, 1 1/4, 1 1/2, 2	–
Distributor blocks MS-FRM-FRZ								
Compressed air distributors with 4 connections and half the grid width								Datasheets → Internet: ms-frm-frz
	Compressed air distributors with 4 connections and half the grid width	4	–	–	–	–	–	–
		6	–	–	–	–	–	–
Flow sensors SFAM								
For absolute flow rate information and cumulative air consumption measurement								Datasheets → Internet: sfam
	For absolute flow rate information and cumulative air consumption measurement	6	–	–	–	–	1/2	1/2
		9	–	–	–	–	1, 1 1/2	1, 1 1/2

Peripherals overview

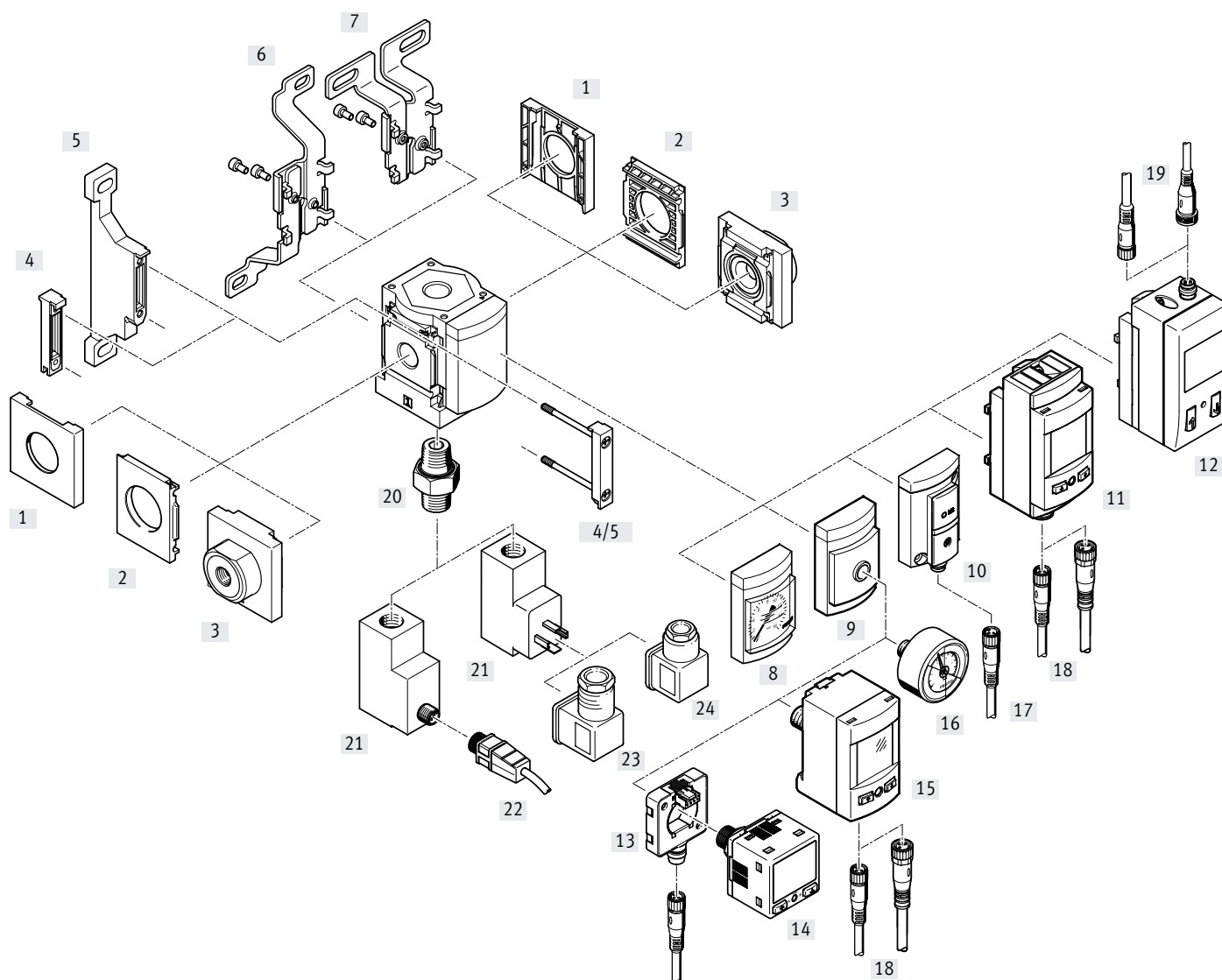

 **Note**

Additional accessories:

- Module connector for combination with size MS4/MS6 or size MS9
→ Internet: amv, rmv, armv
- Adapter for mounting on profiles
→ Internet: ipm-80, ipm-40-80, ipm-80-80

Peripherals overview

Mounting attachments and accessories		Order code	→ Page/Internet
Can be ordered via the modular product system			
[3]	Connecting plate SET ¹⁾	[AG...]	18
[5]	Mounting bracket	[WP]	
	Mounting bracket (not shown)	[WPM]	
[6]	Mounting bracket	[WB]	
[7]	Mounting bracket	[WBM]	
[8]	MS pressure gauge	[AG]/[RG]	
[9]	Adapter for EN pressure gauge 1/8, 1/4	[A8]/[A4]	
[10]	Pressure sensor SDE5 with status indicator	[AD7]/[AD8]/[AD9]/[AD10]	
[11]	Pressure sensor SPAU with LCD display	[AD11]/[AD12]	
[12]	Pressure sensor SDE1 with LCD display	[AD1]/[AD2]/[AD3]/[AD4]	
[21]	Pressure switch PEV ²⁾	[X]/[Y]/[M12]	
Can be ordered as accessories			
[1]	Cover cap	MS4/6-END	ms4-end, ms6-end
[2]	Mounting plate ³⁾	MS4/6-AEND	ms4-aend, ms6-aend
[3]	Connecting plate SET ³⁾	MS4/6-AG...	ms4-ag, ms6-ag
[4]	Module connector	MS4/6-MV	ms4-mv, ms6-mv
[5]	Mounting bracket	MS4/6-WP	ms4-wp, ms6-wp
	Mounting bracket (not shown)	MS4/6-WPB/WPE/WPM	ms4-wp, ms6-wp
[6]	Mounting bracket	MS4/6-WB	ms4-wb, ms6-wb
[7]	Mounting bracket	MS4-WBM	ms4-wbm
[13]	Electrical adapter	SASC	36
[14]	Pressure sensor	SPAN	36
[15]	Pressure sensor	SPAU-...-T	36
[16]	Pressure gauge	MA	36
[17]	Connecting cable	NEBU-M8...-LE3	37
[18]	Connecting cable	NEBU-M8...-LE4/NEBU-M12...-LE4	37
[19]	Connecting cable	NEBU-M8...-LE3/NEBU-M12...-LE4	37
[20]	Double nipple	ESK	37
[22]	Connecting cable	NEBU-M12...-LE4	37
[23]	Angled plug socket	PEV-1/4-WD-LED-...	37
[24]	Plug socket	MSSD-C-4P	37

1) Module connector [4] is included in the scope of delivery.

2) Double nipple [20] is included in the scope of delivery.

3) Module connector MS4/6-MV [4] or mounting bracket MS4/6-WP/WPB/WPE/WPM [5] is required for mounting.

Type codes – MS4-FRM

001	Series	
MS4	MS series, size 4	
002	Size	
4	Grid dimension 40 mm	
003	Function	
FRM	Branching module	
004	Pneumatic connection	
1/8	Female thread G1/8	
1/4	Female thread G1/4	
AGA	Sub-base G1/8	
AGB	Sub-base G1/4	
AGC	Sub-base G3/8	
005	Additional function	
	None	
I	With integrated non-return function	
006	Pressure gauge alternatives	
	None	
AG	MS pressure gauge	
A8	Adapter for EN pressure gauge 1/8, without pressure gauge	
A4	Adapter for EN pressure gauge 1/4, without pressure gauge	
RG	Integrated pressure gauge, red/green scale	
AD1	Pressure sensor with LCD display, M8 plug, PNP, 3-pin	
AD2	Pressure sensor with LCD display, M8 plug, NPN, 3-pin	
AD3	Pressure sensor with LCD display, M12 plug, PNP, 4-pin, analogue output 4 ... 20 mA	
AD4	Pressure sensor with LCD display, M12 plug, NPN, 4-pin, analogue output 4 ... 20 mA	
AD7	Pressure sensor with switching display, M8 plug, threshold value comparator, PNP, N/O	
AD8	Pressure sensor with switching display, M8 plug, threshold value comparator, PNP, N/C	
AD9	Pressure sensor with switching display, M8 plug, window comparator, PNP, N/O	
AD10	Pressure sensor with operational status indicator, M8 plug, window comparator, PNP, N/C	
AD11	Pressure sensor with LCD display, M12 plug, 4-pin, IO-Link®, PNP, NPN, 0...10 V, 1...5 V, 4...20 mA	
AD12	Pressure sensor with LCD display, M8 plug, 4-pin, IO-Link®, PNP, NPN, 0...10 V, 1...5 V, 4...20 mA	

007	Alternative pressure gauge scale	
	MS pressure gauge	
PSI	psi	
MPa	MPa	
008	Pressure switch	
	None	
X	Pressure switch PEV with display, plug socket, EN 175301, type A, cube	
Y	Pressure switch PEV without display, plug socket, EN 175301, type A, cube	
M12	Pressure switch PEV without display, plug socket, round, M12, 4-pin	
009	Type of mounting	
	Without mounting bracket	
WP	Mounting bracket basic design	
WPM	Mounting bracket for hooking in service unit components	
WB	Mounting centrally at rear (wall mounting top and bottom), connecting plates not required	
WBM	Mounting centrally at rear (wall mounting top), connecting plates not required	
010	EU certification	
	None	
EX4	II 2GD	
011	UL certification	
	None	
UL1	cULus ordinary location for Canada and USA	
012	Flow direction	
	Flow direction from left to right	
Z	Flow direction from right to left	

Type codes – MS6-FRM

001	Series
MS6	MS-series, size 6
002	Size
6	Grid dimension 62 mm
003	Function
FRM	Branching module
004	Pneumatic connection
1/4	Female thread G1/4
3/8	Female thread G3/8
1/2	Female thread G1/2
AGB	Sub-base G1/4
AGC	Sub-base G3/8
AGD	Sub-base G1/2
AGE	Sub-base G3/4
005	Additional function
	None
I	With integrated non-return function
006	Pressure gauge alternatives
	None
AG	MS pressure gauge
A8	Adapter for EN pressure gauge 1/8, without pressure gauge
A4	Adapter for EN pressure gauge 1/4, without pressure gauge
RG	Integrated pressure gauge, red/green scale
AD1	Pressure sensor with LCD display, M8 plug, PNP, 3-pin
AD2	Pressure sensor with LCD display, M8 plug, NPN, 3-pin
AD3	Pressure sensor with LCD display, M12 plug, PNP, 4-pin, analogue output 4 ... 20 mA
AD4	Pressure sensor with LCD display, M12 plug, NPN, 4-pin, analogue output 4 ... 20 mA
AD7	Pressure sensor with switching display, M8 plug, threshold value comparator, PNP, N/O
AD8	Pressure sensor with switching display, M8 plug, threshold value comparator, PNP, N/C
AD9	Pressure sensor with switching display, M8 plug, window comparator, PNP, N/O
AD10	Pressure sensor with operational status indicator, M8 plug, window comparator, PNP, N/C
AD11	Pressure sensor with LCD display, M12 plug, 4-pin, IO-Link®, PNP, NPN, 0...10 V, 1...5 V, 4...20 mA
AD12	Pressure sensor with LCD display, M8 plug, 4-pin, IO-Link®, PNP, NPN, 0...10 V, 1...5 V, 4...20 mA

007	Alternative pressure gauge scale
	MS pressure gauge
PSI	psi
MPA	MPa

008	Pressure switch
	None
X	Pressure switch PEV with display, plug socket, EN 175301, type A, cube
Y	Pressure switch PEV without display, plug socket, EN 175301, type A, cube
M12	Pressure switch PEV without display, plug socket, round, M12, 4-pin

009	Type of mounting
	Without mounting bracket
WP	Mounting bracket basic design
WPM	Mounting bracket for hooking in service unit components
WB	Mounting centrally at rear (wall mounting top and bottom), connecting plates not required

010	EU certification
	None
EX4	II 2GD

011	UL certification
	None
UL1	cULus ordinary location for Canada and USA

012	Flow direction
	Flow direction from left to right
Z	Flow direction from right to left

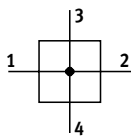

Datasheet

Function
Standard

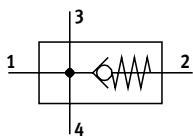

With integrated non-return function



-  - Flow rate
1200 ... 14700 l/min
-  - Temperature range
-10 ... +60°C
-  - Operating pressure
0 ... 20 bar



- Compressed air distributors with 4 connections
- Can be used as an intermediate distributor for varying air qualities
- Attachment option for auxiliary modules
- Outlet at the top and underneath
- An integrated check valve prevents return flow, e.g. of lubricated compressed air
- Optional pressure sensor
- Optional device variant EX4 for use in potentially explosive areas in zones 1, 2, 21 and 22

General technical data

Size	MS4	MS6
Pneumatic connection 1, 2		
Female thread	G1/8 or G1/4	G1/4, G3/8 or G1/2
Connecting plate [AG...]	G1/8, G1/4 or G3/8	G1/4, G3/8, G1/2 or G3/4
Pneumatic connection 3, 4	G1/4	G1/2
Design	Branching module Branching module with non-return function	
Type of mounting	With accessories In-line installation	
Mounting position	Any ¹⁾	
Pressure indicator	Via pressure sensor for indicating the output pressure via LCD display and electrical output Via pressure sensor for indicating the output pressure via switching status indicator and electrical output Via pressure gauge for indicating the output pressure Via pressure gauge with red/green scale for indicating the output pressure Prepared for G1/8 Prepared for G1/4	

1) The branching module must be mounted vertically when combined with a pressure sensor as condensate must not collect in the pressure sensor.

† Note: This product conforms to ISO 1179-1 and ISO 228-1.

Standard nominal flow rate $q_{nN}^{1)}$ [l/min]

Size	MS4		MS6		
Pneumatic connection 1, 2	G1/8	G1/4	G1/4	G3/8	G1/2
Standard					
In main flow direction 1 → 2	1800	4600	4200	9200	14700
Outlet at the top	1600	1500	6000	4700	4400
Outlet underneath	1700	1500	6400	4800	4600
With non-return function					
In main flow direction 1 → 2	1200	1750	3200	5500	6000
Outlet at the top	500	500	2700	2900	3100
Outlet underneath	500	500	2800	3200	3300

1) Measured at $p_1 = 6$ bar and $p_2 = 5$ bar, $\Delta p = 1$ bar

Electrical data¹⁾

Operating voltage range AC	[V]	0 ... 250
Operating voltage range DC	[V]	0 ... 125

1) Only in combination with pressure switch

Datasheet

Operating and environmental conditions						
Size	MS4			MS6		
Branching module	Without pressure switch/pressure sensor	With pressure switch	With pressure sensor	Without pressure switch/pressure sensor	With pressure switch	With pressure sensor
Operating pressure [bar]	0 ... 14 (0 ... 10) ¹⁾	0 ... 12 (0 ... 10) ¹⁾	0 ... 10	0 ... 20 (0 ... 10) ¹⁾	0 ... 12 (0 ... 10) ¹⁾	0 ... 10
Operating medium	Compressed air to ISO 8573-1:2010 [7:4:4] Inert gases					
Note on the operating/pilot medium	Lubricated operation possible (in which case lubricated operation will always be required)					
Ambient temperature [°C]	-10 ... +60		0 ... +50	-10 ... +60		0 ... +50
Temperature of medium [°C]	-10 ... +60		0 ... +50	-10 ... +60		0 ... +50
Storage temperature [°C]	-10 ... +60					
Corrosion resistance class CRC ²⁾	2					
Suitability for the food industry ³⁾	See supplementary material information					
UL certification ³⁾	c UL us - Recognized (OL)					

1) Value in brackets applies to MS4-FRM with non-return function or to MS4/MS6-FRM with UL certification.

2) Corrosion resistance class CRC 2 to Festo standard FN 940070

Moderate corrosion stress. Indoor applications in which condensation can occur. External visible parts with primarily decorative surface requirements which are in direct contact with a normal industrial environment.

3) Additional information: www.festo.com/catalogue/ms → Support/Downloads.

ATEX	
EU certification	[EX4]
ATEX category for gas	II 2G
Type of ignition protection for gas	Ex h IIC T6 Gb X
ATEX category for dust	II 2D
Type of ignition protection for dust	Ex h IIIC T60°C Db X
Explosion-proof ambient temperature	-10°C ≤ Ta ≤ +60°C
CE marking (see declaration of conformity) ¹⁾	To EU Explosion Protection Directive (ATEX)

1) Additional information: www.festo.com/catalogue/ms → Support/Downloads.

Weights [g]		
Size	MS4	MS6
Branching module	165	458
Branching module with non-return function	160	400
Branching module with pressure sensor for LCD display	245	528
Branching module with pressure sensor for status indicator	182	488
Branching module with pressure switch	405	736

Materials

Sectional view

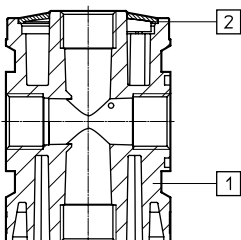

Branching module	
[1] Housing	Die-cast aluminium
[2] Cover	Reinforced PA
Note on materials	RoHS-compliant Free of copper and PTFE (not with MS pressure gauge with standard scale or pressure sensor)

Datasheet

Dimensions – Basic version

Download CAD data → www.festo.com

With female thread, with cover plate

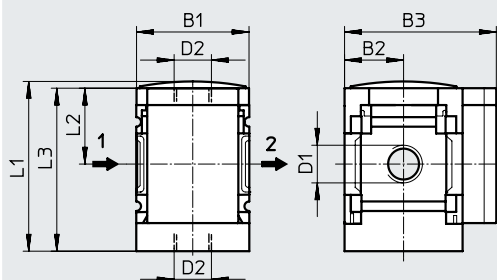

→ Flow direction

Type	B1	B2	B3	D1	D2	L1	L2	L3
MS4-FRM-1/8	40	21	54	G1/8	G1/4	60.4	27	58
MS4-FRM-1/4				G1/4				
MS6-FRM-1/4	62	31	76	G1/4	G1/2	87.2	39	84.5
MS6-FRM-3/8				G3/8				
MS6-FRM-1/2				G1/2				

↓ Note: This product conforms to ISO 1179-1 and ISO 228-1.

Dimensions – Pressure gauges/adapters

Download CAD data → www.festo.com

[AG] Integrated MS pressure gauge with standard scale

[RG] Integrated MS pressure gauge with red/green scale

[A8] Adapter for EN pressure gauge 1/8, without pressure gauge

[A4] Adapter for EN pressure gauge 1/4, without pressure gauge

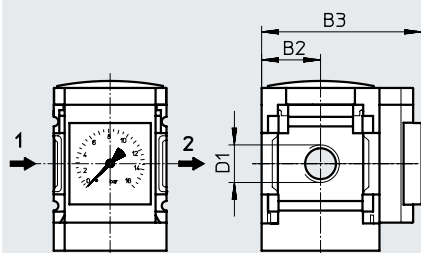

→ Flow direction

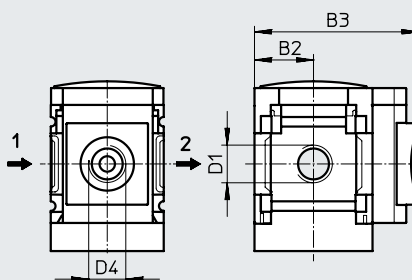

→ Flow direction

Type	B2	B3		D1	D4
		Standard	With integrated non-return function		
MS4-FRM-1/8-...-AG	21	65		G1/8	-
MS4-FRM-1/4-...-AG		66.5		G1/4	
MS4-FRM-1/8-...-RG	21	58.5		G1/8	G1/8
MS4-FRM-1/4-...-RG		58.5		G1/4	
MS4-FRM-1/8-...-A8	21	85		G1/8	G1/4
MS4-FRM-1/4-...-A8		85		G1/4	
MS4-FRM-1/8-...-A4	21	86.5		G1/8	-
MS4-FRM-1/4-...-A4		86.5		G1/4	
MS6-FRM-1/4-...-AG	31	78.5		G1/4	-
MS6-FRM-3/8-...-AG		78.5		G3/8	
MS6-FRM-1/2-...-AG	31	78.5		G1/2	G1/8
MS6-FRM-1/4-...-RG		78.5		G1/4	
MS6-FRM-3/8-...-RG	31	78.5		G3/8	-
MS6-FRM-1/2-...-RG		78.5		G1/2	
MS6-FRM-1/4-...-A8	31	78.5		G1/4	G1/8
MS6-FRM-3/8-...-A8		78.5		G3/8	
MS6-FRM-1/2-...-A8	31	78.5		G1/2	G1/4
MS6-FRM-1/4-...-A4		78.5		G1/4	
MS6-FRM-3/8-...-A4	31	78.5		G3/8	G1/4
MS6-FRM-1/2-...-A4		78.5		G1/2	

Datasheet

Dimensions – Pressure sensor

Download CAD data → www.festo.com

[AD1]/[AD2]/[AD3]/[AD4] Pressure sensor with LCD display

Datasheets → Internet: sde1

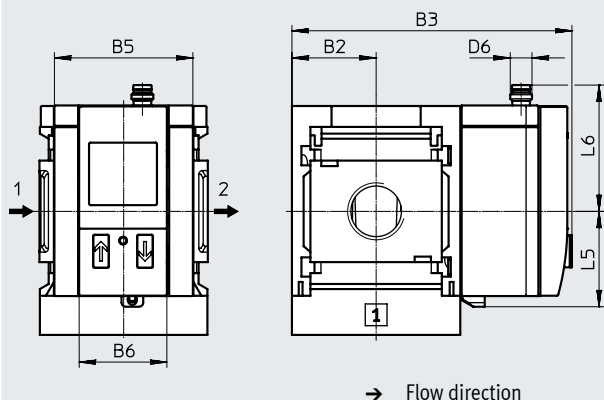

[AD1]:
SDE1-D10-G2-MS...-L-P1-M8 with 3-pin plug M8x1, 1 switching output PNP

[AD3]:
SDE1-D10-G2-MS...-L-PI-M12 with 4-pin plug M12x1, 1 switching output PNP and 4 ... 20 mA analogue

[AD2]:
SDE1-D10-G2-MS...-L-N1-M8 with 3-pin plug M8x1, 1 switching output NPN

[AD4]:
SDE1-D10-G2-MS...-L-NI-M12 with 4-pin plug M12x1, 1 switching output NPN and 4 ... 20 mA analogue

[AD7]/[AD8]/[AD9]/[AD10] Pressure sensor with status indicator

Datasheets → Internet: sde5

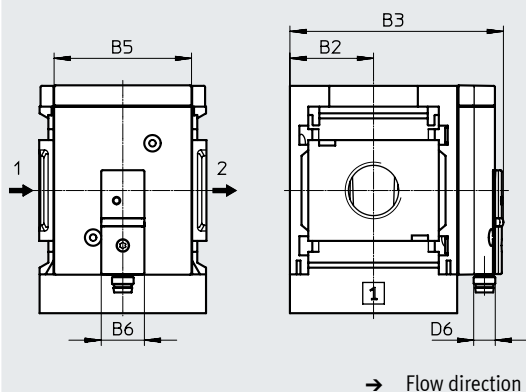

[AD7]:
SDE5-D10-O-...-P-M8 with 3-pin plug M8x1, threshold value comparator, 1 switching output PNP, N/O contact

[AD9]:
SDE5-D10-O3-...-P-M8 with 3-pin plug M8x1, window comparator, 1 switching output PNP, N/O contact

[AD8]:
SDE5-D10-C-...-P-M8 with 3-pin plug M8x1, threshold value comparator, 1 switching output PNP, N/C contact

[AD10]:
SDE5-D10-C3-...-P-M8 with 3-pin plug M8x1, window comparator, 1 switching output PNP, N/C contact

[AD11]/[AD12] Pressure sensor with LCD display

Datasheets → Internet: spau

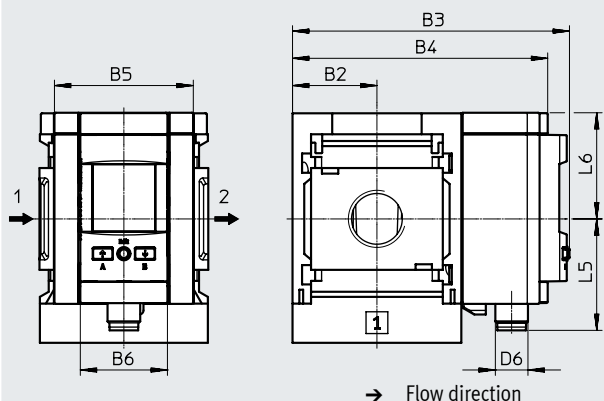

[AD11]:
SPAU-P10R-MS...-L-PNLK-M12D with 4-pin plug M12x1 A-coded, switching output 2x PNP or 2x NPN switchable and 0 ... 10 V, 1 ... 5 V, 4 ... 20 mA analogue

[AD12]:
SPAU-P10R-MS...-L-PNLK-M8D with 4-pin plug M8x1 A-coded, switching output 2x PNP or 2x NPN switchable and 0 ... 10 V, 1 ... 5 V, 4 ... 20 mA analogue

Type	B2	B3	B4	B5	B6	D6	L5	L6
MS4-...AD1/AD2	21	82.6	-	32	32.3	M8x1	35.1	46.7
MS4-...AD3/AD4						M12x1		55.8
MS4-...AD7/AD8/AD9/AD10	21	59.1	-	~32	16	M8x1	-	-
MS4-...AD11	21	81.2	73.3	32	32	M12x1	37.9	41.2
MS4-...AD12						M8x1		39
MS6-...AD1/AD2	31	103	-	51	32.3	M8x1	35.1	46.7
MS6-...AD3/AD4						M12x1		55.8
MS6-...AD7/AD8/AD9/AD10	31	79.1	-	~51	16	M8x1	-	-
MS6-...AD11	31	101.8	93.7	51	32	M12x1	37.9	41.2
MS6-...AD12						M8x1		39

Datasheet

Dimensions – Pressure switch

[X]/[Y]/[M12] Pressure switch with adjustable pressure switching point

[X]/[Y]

[M12]

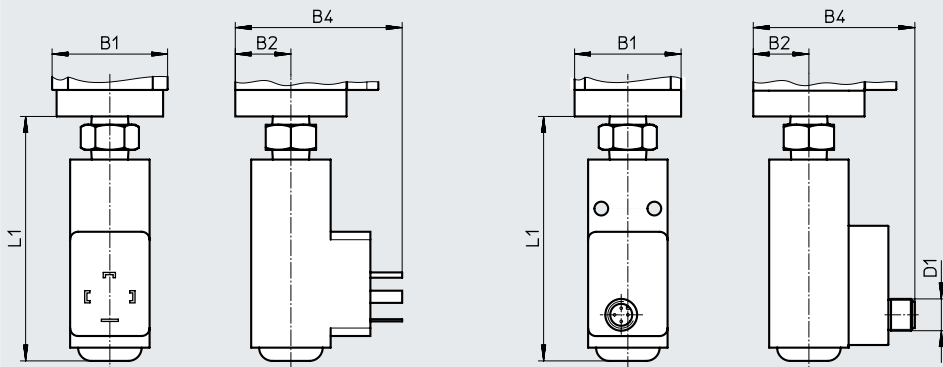

Download CAD data → www.festo.com

Datasheets → Internet: pev-1/4

[X]:
PEV-1/4-SC-0D with display, plug, square design to EN 175 301, type A

[Y]:
PEV-1/4-B-0D, plug, square design to EN 175 301, type A

[M12]:
PEV-1/4-B-M12 with 4-pin plug M12x1

Type	B1	B2	B4	D1	L1
MS4-FRM-...-X/Y	40	21	63	–	91.8
MS4-FRM-...-M12	40	21	61	M12x1	91.8
MS6-FRM-...-X/Y	62	31	73	–	99
MS6-FRM-...-M12	62	31	71	M12x1	99

Datasheet

★ Core Range

Ordering data					
Size	Port 1, 2	Port 3, 4	Flow direction	Part no.	Type
MS6	G1/4	G thread	From left to right	★ 529857	MS6-FRM-1/4
	G1/2	G thread	From left to right	★ 529853	MS6-FRM-1/2

Ordering data					
Size	Port 1, 2	Port 3, 4	Flow direction	Part no.	Type
MS4	G1/8	G thread	From left to right	529559	MS4-FRM-1/8
	G1/4	G thread	From left to right	529555	MS4-FRM-1/4
			From right to left	529558	MS4-FRM-1/4-Z
MS6	G3/8	G thread	From left to right	529861	MS6-FRM-3/8
	G1/2	G thread	From right to left	529856	MS6-FRM-1/2-Z

With integrated non-return function					
MS4	G1/4	G thread	From left to right	536966	MS4-FRM-1/4-I
			From right to left	536971	MS4-FRM-1/4-I-Z
MS6	G1/4	G thread	From left to right	536967	MS6-FRM-1/4-I
	G1/2	G thread	From left to right	536969	MS6-FRM-1/2-I

With pressure switch PEV-1/4-B-0D					
MS4	G1/4	G thread	From left to right	529556	MS4-FRM-1/4-Y
			From right to left	529557	MS4-FRM-1/4-Y-Z
MS6	G1/4	G thread	From left to right	529858	MS6-FRM-1/4-Y
	G3/8	G thread	From left to right	529862	MS6-FRM-3/8-Y
	G1/2	G thread	From left to right	529854	MS6-FRM-1/2-Y
			From right to left	529855	MS6-FRM-1/2-Y-Z

Ordering data – Modular product system

Ordering table						
Grid dimension	[mm]	40	62	Conditions	Code	Enter code
Module no.		527703	527676			
Series		Standard			MS	MS
Size		4	6		...	
Function		Branching module			-FRM	-FRM
Pneumatic connection	Female thread G1/8		–	[1]	-1/8	
	Female thread G1/4		Female thread G1/4	[1]	-1/4	
	–		Female thread G3/8	[1]	-3/8	
	–		Female thread G1/2	[1]	-1/2	
	Connecting plate G1/8		–		-AGA	
	Connecting plate G1/4		Connecting plate G1/4		-AGB	
	Connecting plate G3/8		Connecting plate G3/8		-AGC	
	–		Connecting plate G1/2		-AGD	
	–		Connecting plate G3/4		-AGE	
Additional function	None					
	With integrated non-return function				-I	
Pressure gauge/adapter	None					
	MS pressure gauge, bar				-AG	
	Adapter for EN pressure gauge 1/8, without pressure gauge				-A8	
	Adapter for EN pressure gauge 1/4, without pressure gauge				-A4	
	Integrated pressure gauge, red/green scale				-RG	
	Pressure sensor with LCD display, plug M8, 1 switching output PNP, 3-pin			[1] [2]	-AD1	
	Pressure sensor with LCD display, plug M8, 1 switching output NPN, 3-pin			[1] [2]	-AD2	
	Pressure sensor with LCD display, plug M12, 1 switching output PNP, 4-pin, analogue output 4 ... 20 mA			[1] [2]	-AD3	
	Pressure sensor with LCD display, plug M12, 1 switching output NPN, 4-pin, analogue output 4 ... 20 mA			[1] [2]	-AD4	
	Pressure sensor with switching status indicator, plug M8, threshold value comparator, PNP, N/O contact			[1] [2]	-AD7	
	Pressure sensor with switching status indicator, plug M8, threshold value comparator, PNP, N/C contact			[1] [2]	-AD8	
	Pressure sensor with switching status indicator, plug M8, window comparator, PNP, N/O contact			[1] [2]	-AD9	
	Pressure sensor with switching status indicator, plug M8, window comparator, PNP, N/C contact			[1] [2]	-AD10	
	Pressure sensor with LCD display, plug M12, 4-pin, IO-Link, PNP, NPN, 0... 10 V, 1 ... 5 V, 4 ... 20 mA			[1] [2]	-AD11	
Pressure sensor with LCD display, plug M8, 4-pin, IO-Link, PNP, NPN, 0... 10 V, 1 ... 5 V, 4 ... 20 mA			[1] [2]	-AD12		
Alternative pressure gauge scale	None					
	psi			[3]	-PSI	
	MPa			[4]	-MPA	

[1] 1/8, 1/4, 3/8, Not with EU EX4 certification.
1/2, AD1 ... AD4,
AD7 ... AD12, X, Y,
M12, WPM

[2] AD1 ... AD4, Measuring range max. 10 bar.
AD7 ... AD12

[3] PSI Only in combination with pressure gauge AG.

[4] MPA Only in combination with pressure gauge AG or RG.

Ordering data – Modular product system

Ordering table		Grid dimension	[mm]	40	62	Conditions	Code	Enter code
Pressure switch	Without pressure switch							
	Pressure switch PEV with display, plug socket, EN 175301, type A, cube				[1] [5]		-X	
	Pressure switch PEV without display, plug socket, EN 175301, type A, cube				[1] [5]		-Y	
	Pressure switch PEV without display, plug socket, round, M12, 4-pin				[1] [5]		-M12	
Type of mounting	Without mounting bracket							
	Mounting bracket standard design				[6]		-WP	
	Mounting bracket for attaching service unit components				[1] [6]		-WPM	
	Mounting bracket centrally at rear (wall mounting top and bottom), connecting plates not required						-WB	
Mounting bracket centrally at rear (wall mounting top), connecting plates not required						-WBM		
EU certification	None							
	II 2GD to EU Explosion Protection Directive (ATEX)						-EX4	
UL certification	None							
	cULus, ordinary location for Canada and USA						-UL1	
Flow direction	Flow direction from left to right							
	Flow direction from right to left						-Z	

[1] 1/8, 1/4, 3/8, 1/2, AD1 ... AD4, AD7 ... AD12, X, Y, M12, WPM

Not with EU EX4 certification.

[5] X, Y, M12

Max. permissible operating pressure P1 = 12 bar.



[6] WP, WPM

Only with connecting plate AGA, AGB, AGC, AGD or AGE.

Datasheet

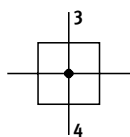
Function



-  - Flow rate
2900 ... 14600 l/min
-  - Temperature range
-10 ... +60°C
-  - Operating pressure
0 ... 20 bar



Note

The distributor block MS4/6-FRM-FRZ has half the normal grid dimension.

- Compressed air distributors with 4 connections
- Outlet at the top and underneath
- Can be used as an intermediate distributor for varying air qualities
- Can be used as an adapter for size MS4 between two pressure regulators with pressure gauge with large rotary knob

General technical data

Size	MS4	MS6
Pneumatic connection 3, 4	G1/4	G1/2
Design	Branching module	
Type of mounting	With accessories In-line installation	
Mounting position	Any	

† Note: This product conforms to ISO 1179-1 and ISO 228-1.

Standard nominal flow rate $q_{nN}^{1)}$ [l/min]

Size	MS4	MS6
In main flow direction 1 → 2	4050	14600
Outlet at the top	3250	10400
Outlet underneath	2900	9850

1) Measured at $p_1 = 6$ bar and $p_2 = 5$ bar, $\Delta p = 1$ bar

Operating and environmental conditions

Size	MS4	MS6
Operating pressure [bar]	0 ... 14 (0 ... 10) ¹⁾	0 ... 20 (0 ... 10) ¹⁾
Operating medium	Compressed air to ISO 8573-1:2010 [7:4:4] Inert gases	
Note on the operating/pilot medium	Lubricated operation possible (in which case lubricated operation will always be required)	
Ambient temperature [°C]	-10 ... +60	
Temperature of medium [°C]	-10 ... +60	
Storage temperature [°C]	-10 ... +60	
Corrosion resistance class CRC ²⁾	2	
UL certification ³⁾	c UL us - Recognized (OL)	

1) Value in brackets applies to installation in a service unit MS4/MS6 with UL certification.

2) Corrosion resistance class CRC 2 to Festo standard FN 940070

Moderate corrosion stress. Indoor applications in which condensation can occur. External visible parts with primarily decorative surface requirements which are in direct contact with a normal industrial environment.

3) Additional information: www.festo.com/catalogue/ms → Support/Downloads.

Datasheet

Weights [g]		
Size	MS4	MS6
Distributor block	60	163

Materials

Sectional view

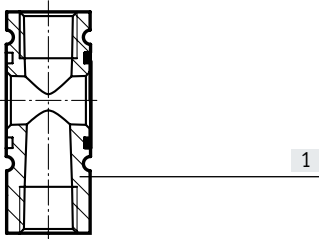

Distributor block	
[1] Housing	Die-cast aluminium
Note on materials	RoHS-compliant
	Free of copper and PTFE

Dimensions

Download CAD data → www.festo.com

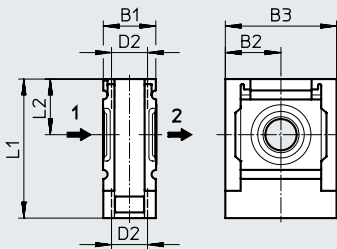

Type	B1	B2	B3	D2	L1	L2
MS4-FRM-FRZ	20	21	42	G1/4	52.5	21
MS6-FRM-FRZ	31	31	62	G1/2	76.5	31

† Note: This product conforms to ISO 1179-1 and ISO 228-1.

★ Core Range

Ordering data

Size	Port 1, 2	Port 3, 4	Flow direction	Part no.	Type
MS4	Without connecting thread	G thread	–	★ 549336	MS4-FRM-FRZ
MS6		G thread	–	★ 549337	MS6-FRM-FRZ

Peripherals overview

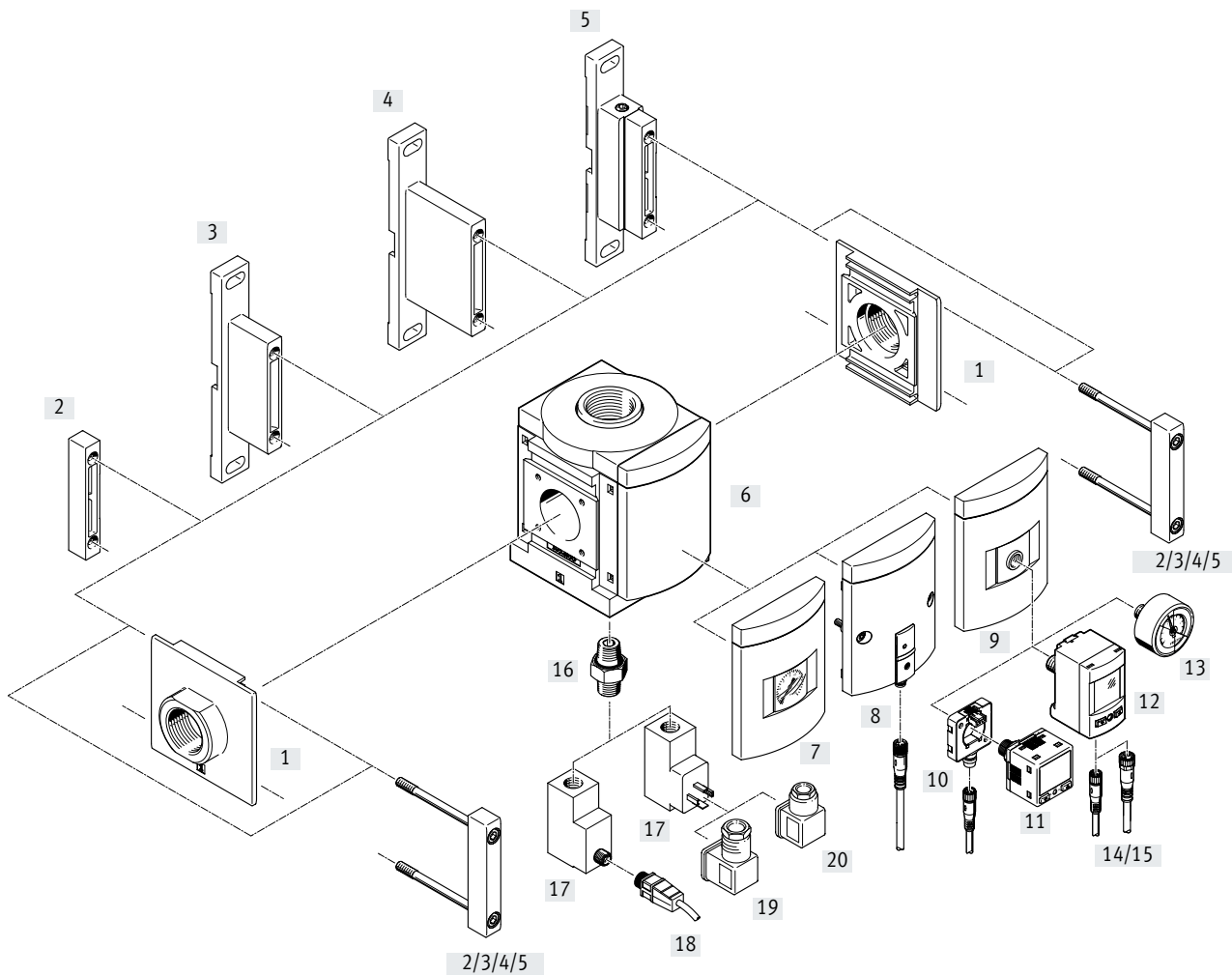

-  - **Note**
 Additional accessories:
 • Module connector for combination with size MS6, MS9 or MS12
 → Internet: rmv, armv

Peripherals overview

Mounting attachments and accessories		Order code	→ Page/Internet
Can be ordered via the modular product system			
[1]	Connecting plate SET ¹⁾	[AG...]	30
	Connecting plate SET ¹⁾	[AQ...]	
[3]	Mounting bracket	[WP]	
[4]	Mounting bracket	[WPB]	
[5]	Mounting bracket	[WPM]	
[6]	Cover plate	[VS]	
[7]	MS pressure gauge	[AG]/[RG]	
[8]	Pressure sensor SDE5 with status indicator	[AD7]/[AD8]/[AD9]/[AD10]	
[9]	Adapter for EN pressure gauge 1/8, 1/4	[A8]/[A4]	
[17]	Pressure switch PEV ²⁾	[X]/[Y]/[M12]	
Can be ordered as accessories			
[1]	Connecting plate SET	MS9-AG...	ms9-ag
	Connecting plate SET	MS9-AQ...	ms9-aq
[2]	Module connector	MS9-MV	ms9-mv
[3]	Mounting bracket	MS9-WP	ms9-wp
[4]	Mounting bracket	MS9-WPB	ms9-wp
[5]	Mounting bracket	MS9-WPM	ms9-wp
[10]	Electrical adapter	SASC	36
[11]	Pressure sensor	SPAN	36
[12]	Pressure sensor	SPAU-...-T	36
[13]	Pressure gauge	MA	36
[14]	Connecting cable	NEBU-M8...-LE3	37
[15]	Connecting cable	NEBU-M8...-LE4/NEBU-M12...-LE4	37
[18]	Connecting cable	NEBU-M12...-LE4	37
[19]	Angled plug socket	PEV-1/4-WD-LED-...	37
[20]	Plug socket	MSSD-C-4P	37

1) Module connector [2] is included in the scope of delivery.

2) Double nipple [16] is included in the scope of delivery.

Type codes

001	Series	
MS	MS series	

002	Size	
9	Grid dimension 90 mm	

003	Function	
FRM	Branching module	

004	Pneumatic connection	
3/4	Female thread G3/4	
1	Female thread G1	
AGD	Sub-base G1/2	
AGE	Sub-base G3/4	
AGF	Sub-base G1	
AGG	Sub-base G11/4	
AGH	Sub-base G11/2	
N3/4	3/4 NPT	
N1	1 NPT	
AQR	Sub-base 1/2 NPT	
AQS	Sub-base 3/4 NPT	
AQT	Sub-base 1 NPT	
AQU	Sub-base 1 1/4 NPT	
AQV	Sub-base 1 1/2 NPT	
G	Module without connecting thread, without sub-base	
NG	Module without connecting thread, without sub-base (inch)	

005	Pressure gauge alternatives	
AG	MS pressure gauge	
VS	Cover plate	
A8	Adapter for EN pressure gauge 1/8, without pressure gauge	
A4	Adapter for EN pressure gauge 1/4, without pressure gauge	
RG	Integrated pressure gauge, red/green scale	
AD7	Pressure sensor with switching display, M8 plug, threshold value comparator, PNP, N/O	
AD8	Pressure sensor with switching display, M8 plug, threshold value comparator, PNP, N/C	
AD9	Pressure sensor with switching display, M8 plug, window comparator, PNP, N/O	
AD10	Pressure sensor with operational status indicator, M8 plug, window comparator, PNP, N/C	

006	Alternative pressure gauge scale	
	MS pressure gauge	
PSI	psi	
MPA	MPa	
BAR	bar	

007	Pressure switch	
	None	
X	Pressure switch PEV with display, plug socket, EN 175301, type A, cube	
Y	Pressure switch PEV without display, plug socket, EN 175301, type A, cube	
M12	Pressure switch PEV without display, plug socket, round, M12, 4-pin	

008	Type of mounting	
	Without mounting bracket	
WP	Mounting bracket basic design	
WPM	Mounting bracket for hooking in service unit components	
WPB	Mounting bracket for large wall gap	

009	EU certification	
	None	
EX4	II 2GD	





010	UL certification	
	None	
UL1	cULus ordinary location for Canada and USA	

011	Flow direction	
	Flow direction from left to right	
Z	Flow direction from right to left	

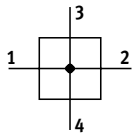
Datasheet

Function



-  Flow rate
10000 ... 50000 l/min
-  Temperature range
-10 ... +60°C
-  Operating pressure
0 ... 20 bar
-  www.festo.com



- Compressed air distributors with 4 connections
- Attachment option for auxiliary modules
- Outlet at the top and underneath
- Can be used as an intermediate distributor for varying air qualities
- Optional device variant EX4 for use in potentially explosive areas in zones 1, 2, 21 and 22
- Optional pressure sensor

General technical data

Pneumatic connection 1, 2		
Female thread		G3/4, G1, 3/4 NPT or 1 NPT
Connecting plate	[AG...]	G1/2, G3/4, G1, G1 1/4 or G1 1/2
	[AQ...]	1/2 NPT, 3/4 NPT, 1 NPT, 1 1/4 NPT or 1 1/2 NPT
Module without connecting thread/connecting plate	[G]/[NG]	-
Pneumatic connection 3, 4		
Pneumatic connection 1, 2	[3/4]/[1]/[AG...]/[G]	G1
	[N3/4]/[N1]/[AQ...]/[NG]	1 NPT
Design		Branching module
Type of mounting		With accessories
		In-line installation
		Front panel mounting
Mounting position		Any ¹⁾
Pressure indicator		Via pressure sensor for indicating the output pressure via switching status indicator and electrical output
		Via pressure gauge for indicating the output pressure
		Via pressure gauge with red/green scale for indicating the output pressure
		Prepared for G1/8
		Prepared for G1/4

1) The branching module must be mounted vertically when combined with a pressure sensor as condensate must not collect in the pressure sensor.

† Note: This product conforms to ISO 1179-1 and ISO 228-1.

Standard nominal flow rate $q_{nN}^{1)}$ [l/min]

Pneumatic connection 1, 2	G1/2, 1/2 NPT	G3/4, 3/4 NPT	G1, 1 NPT	G1 1/4, 1 1/4 NPT	G1 1/2, 1 1/2 NPT
In main flow direction 1 → 2	10000	25000	45000	47000	50000
Outlet at the top	13000				
Outlet underneath	13000				

1) Measured at $p_1 = 6$ bar and $p_2 = 5$ bar, $\Delta p = 1$ bar.

Electrical data¹⁾

Operating voltage range AC	[V]	0 ... 250
Operating voltage range DC	[V]	0 ... 125

1) Only in combination with pressure switch

Datasheet

Operating and environmental conditions			
	Without pressure switch/pressure sensor	Pressure switch	Pressure sensor
Operating pressure [bar]	0 ... 20	0 ... 12	0 ... 10
Operating medium	Compressed air to ISO 8573-1:2010 [7:4:4]		
Note on the operating/pilot medium	Lubricated operation possible		
Ambient temperature [°C]	-10 ... +60	-10 ... +60	0 ... +50
Temperature of medium [°C]	-10 ... +60	-10 ... +60	0 ... +50
Storage temperature [°C]	-10 ... +60	-10 ... +60	-10 ... +60
Corrosion resistance class CRC ¹⁾	2		
UL certification ²⁾	c UL us - Recognized (OL)		

- 1) Corrosion resistance class CRC 2 to Festo standard FN 940070
Moderate corrosion stress. Indoor applications in which condensation can occur. External visible parts with primarily decorative surface requirements which are in direct contact with a normal industrial environment.
- 2) Additional information: www.festo.com/catalogue/ms → Support/Downloads.

ATEX	
EU certification	[EX4]
ATEX category for gas	II 2G
Type of ignition protection for gas	Ex h IIC T6 Gb X
ATEX category for dust	II 2D
Type of ignition protection for dust	Ex h IIIC T60°C Db X
Explosion-proof ambient temperature	-10°C ≤ Ta ≤ +60°C
CE marking (see declaration of conformity) ¹⁾	To EU Explosion Protection Directive (ATEX)

- 1) Additional information: www.festo.com/catalogue/ms → Support/Downloads.

Weights [g]	
Branching module	1000
Branching module with pressure switch	1100

Materials

Sectional view

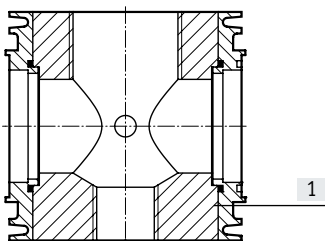

Branching module		
[1]	Housing	Die-cast aluminium
-	Cover	Reinforced PA
-	Connecting plate, module connector, mounting bracket	Die-cast aluminium
Note on materials		RoHS-compliant
		Free of copper and PTFE (not with MS pressure gauge with standard scale or pressure sensor)

Datasheet

Dimensions – Basic version

Download CAD data → www.festo.com

[G]/[NG] Module without connecting thread, without connecting plate
 [VS] Cover plate

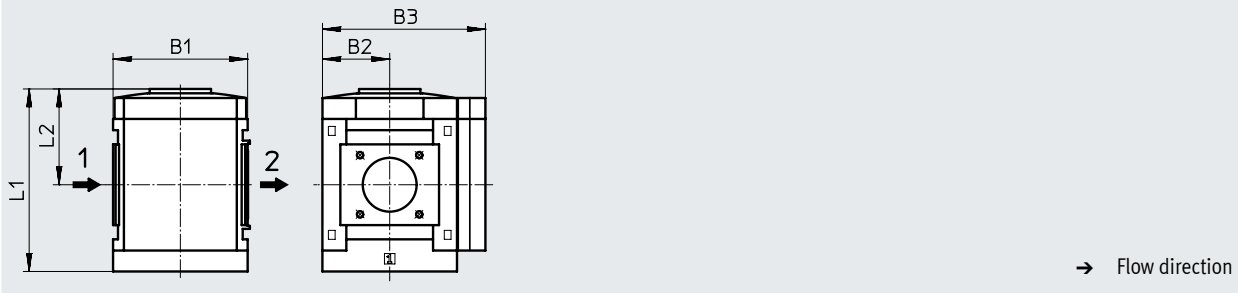

Type	B1	B2	B3	L1	L2
MS9-FRM-G/NG-VS	90	45	109	122	64

Dimensions – Female thread/connecting plate

Download CAD data → www.festo.com

[3/4]/[1]/[N3/4]/[N1] Female thread

[AG...]/[AQ...] Connecting plate

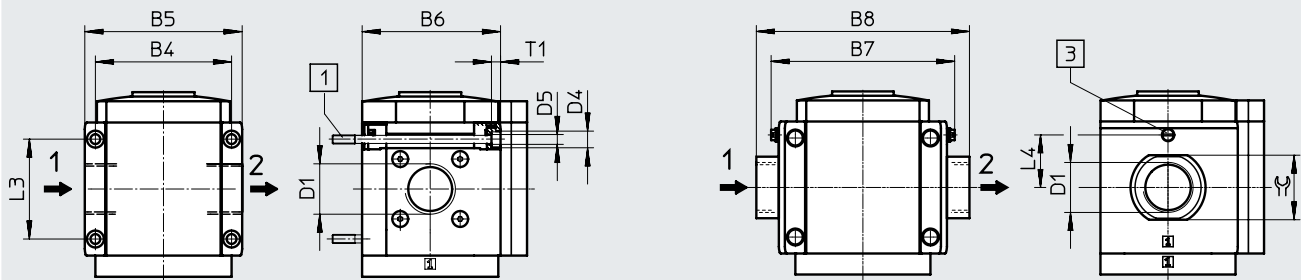

[1] Retaining screw M6xmin. 90 to DIN 912 (not in the scope of delivery) for wall mounting without mounting bracket

[3] Earthing screw M4x8 (only with MS9-...-EX4)

→ Flow direction

Type	B4	B5	B6	B7		B8	D1	D4	D5	L3	L4		T1	☑
					[EX4]							[EX4]		
MS9-FRM-3/4	90	104	91.5	-	-	-	G3/4	11	6.5	66	-	6	-	
MS9-FRM-1							G1							
MS9-FRM-AGD	-	-	-	112	122	-	132	-	-	-	35	-	-	30
MS9-FRM-AGE							G3/4							
MS9-FRM-AGF							G1							
MS9-FRM-AGG							G1 1/4							
MS9-FRM-AGH							G1 1/2							
MS9-FRM-N3/4	90	104	91.5	-	-	-	3/4 NPT	11	6.5	66	-	6	-	
MS9-FRM-N1							1 NPT							
MS9-FRM-AQR	-	-	-	112	-	-	132	-	-	-	-	-	-	30
MS9-FRM-QS							1/2 NPT							
MS9-FRM-AQT							132							
MS9-FRM-AQU							142							
MS9-FRM-AQV							176							
MS9-FRM-AQV	162	1 1/4 NPT	50											
MS9-FRM-AQV	176	1 1/2 NPT	55											

† Note: This product conforms to ISO 1179-1 and ISO 228-1.

Datasheet

Dimensions – Pressure gauges/adapters

Download CAD data → www.festo.com

- [AG] Integrated MS pressure gauge with standard scale
- [RG] Integrated MS pressure gauge with red/green scale

- [A8] Adapter for EN pressure gauge 1/8, without pressure gauge
- [A4] Adapter for EN pressure gauge 1/4, without pressure gauge

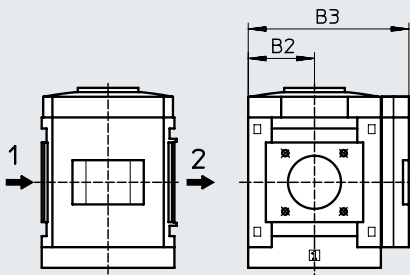

→ Flow direction

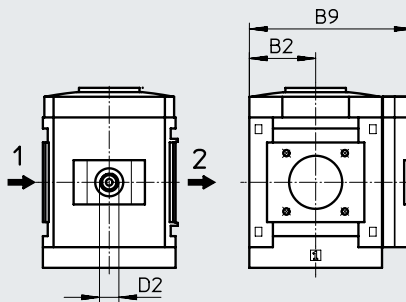

→ Flow direction

Type	B2	B3	B9	D2
MS9-FRM-...-AG/RG	45	109	-	-
MS9-FRM-...-A8		-	110	G1/8
MS9-FRM-...-A4		-		G1/4

Dimensions – Pressure sensor

Download CAD data → www.festo.com

- [AD7]/[AD8]/[AD9]/[AD10] Pressure sensor with status indicator

Datasheets → Internet: [sde5](#)

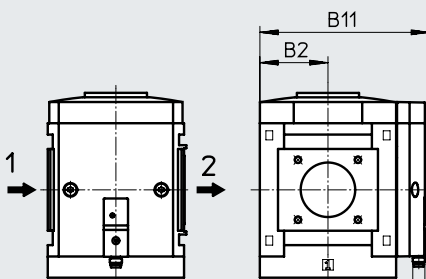

→ Flow direction

- [AD7]:
SDE5-D10-O-...-P-M8 with 3-pin plug M8x1, threshold value comparator, 1 switching output PNP, N/O contact

- [AD9]:
SDE5-D10-O3-...-P-M8 with 3-pin plug M8x1, window comparator, 1 switching output PNP, N/O contact

- [AD8]:
SDE5-D10-C-...-P-M8 with 3-pin plug M8x1, threshold value comparator, 1 switching output PNP, N/C contact

- [AD10]:
SDE5-D10-C3-...-P-M8 with 3-pin plug M8x1, window comparator, 1 switching output PNP, N/C contact

Type	B2	B11	D3
MS9-FRM-...-AD7/AD8/AD9/AD10	45	112	M8

Datasheet

Dimensions – Pressure switch

[X]/[Y]/[M12] Pressure switch with adjustable pressure switching point

[X]/[Y]

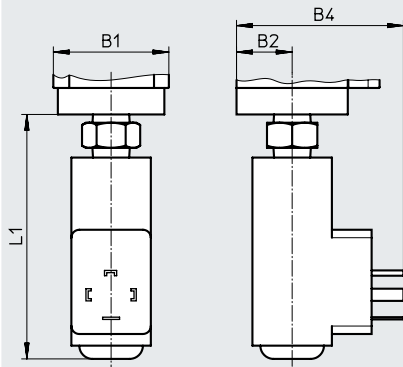

[M12]

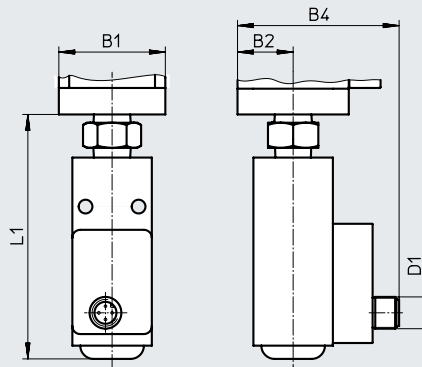
 Download CAD data → www.festo.com

Datasheets → Internet: pev-1/4

[X]:

PEV-1/4-SC-0D with display, plug, square design to EN 175 301, type A

[Y]:

PEV-1/4-B-0D, plug, square design to EN 175 301, type A

[M12]:

PEV-1/4-B-M12 with 4-pin plug M12x1

Type	B1	B2	B4	D1	L1
MS9-FRM-...-X/Y	90	45	87	–	105
MS9-FRM-...-M12	90	45	85	M12x1	105

Ordering data

Cover plate

Size	Port 1, 2	Port 3, 4	Flow direction	Part no.	Type
MS9	Without connecting thread	G thread	From left to right	564145	MS9-FRM-G-VS
		NPT thread	From left to right	564148	MS9-FRM-NG-VS
With pressure switch PEV-1/4-B-0D					
MS9	Without connecting thread	G thread	From left to right	564147	MS9-FRM-G-VS-Y
		NPT thread	From left to right	564150	MS9-FRM-NG-VS-Y

Ordering data – Modular product system

Ordering table		Grid dimension	[mm]	90	Conditions	Code	Enter code
Module no.	562534						
Series	Standard						MS
Size	9						9
Function	Branching module						-FRM
Pneumatic connection	Female thread G3/4	[1]					-3/4
	Female thread G1	[1]					-1
	Connecting plate G1/2						-AGD
	Connecting plate G3/4						-AGE
	Connecting plate G1						-AGF
	Connecting plate G1 1/4						-AGG
	Connecting plate G1 1/2						-AGH
	Female thread 3/4 NPT	[1]					-N3/4
	Female thread 1 NPT	[1]					-N1
	Connecting plate 1/2 NPT	[1]					-AQR
	Connecting plate 3/4 NPT	[1]					-AQS
	Connecting plate 1 NPT	[1]					-AQT
	Connecting plate 1 1/4 NPT	[1]					-AQU
	Connecting plate 1 1/2 NPT	[1]					-AQV
	Module without connecting thread, without connecting plate	[1]					-G
	Module without connecting thread, without connecting plate (pneumatic connections 3 and 4 in NPT)	[1]					-NG
	Pressure gauge/adapter	MS pressure gauge					
Cover plate							-VS
Adapter for EN pressure gauge 1/8, without pressure gauge							-A8
Adapter for EN pressure gauge 1/4, without pressure gauge							-A4
Integrated pressure gauge, red/green scale		[2]					-RG
Pressure sensor with switching status indicator, plug M8, threshold value comparator, PNP, N/O contact		[1] [3]					-AD7
Pressure sensor with switching status indicator, plug M8, threshold value comparator, PNP, N/C contact		[1] [3]					-AD8
Pressure sensor with switching status indicator, plug M8, window comparator, PNP, N/O contact		[1] [3]					-AD9
Pressure sensor with switching status indicator, plug M8, window comparator, PNP, N/C contact		[1] [3]					-AD10
Alternative pressure gauge scale	None	[4]					
	psi	[5]					-PSI
	MPa	[5]					-MPA
	bar	[5]					-BAR
Pressure switch	Without pressure switch						
	Pressure switch PEV with display, plug socket, EN 175301, type A, cube	[1] [6]					-X
	Pressure switch PEV without display, plug socket, EN 175301, type A, cube	[1] [6]					-Y
	Pressure switch PEV without display, plug socket, round, M12, 4-pin	[1] [6]					-M12
Type of mounting	Without mounting bracket						
	Mounting bracket standard design	[7]					-WP
	Mounting bracket for attaching service unit components	[1] [7]					-WPM
	Mounting bracket for large wall gap	[7]					-WPB
EU certification	None						
	II 2GD to EU Explosion Protection Directive (ATEX)						-EX4
UL certification	None						
	cULus, ordinary location for Canada and USA						-UL1
Flow direction	Flow direction from left to right						
	Flow direction from right to left						-Z

[1] 3/4, 1, N3/4, N1, Not with EU EX4 certification.
AQR, AQS, AQT,
AQU, AQV, G, NG,
AD7 ... AD10, X, Y,
M12, WPM

[2] RG Not with alternative pressure gauge scale PSI, PSI scale serves only as an auxiliary scale.

[3] AD7 ... AD10 Measuring range max. 10 bar.

[4] - Not with pressure gauge AG, RG.

[5] PSI, MPA, BAR Not with adapter VS, A8, A4, AD7, AD8, AD9, AD10.

[6] X, Y, M12 Max. permissible operating pressure P1 = 12 bar.

[7] WP, WPM, WPB Not with pneumatic connection G, NG.

Peripherals overview

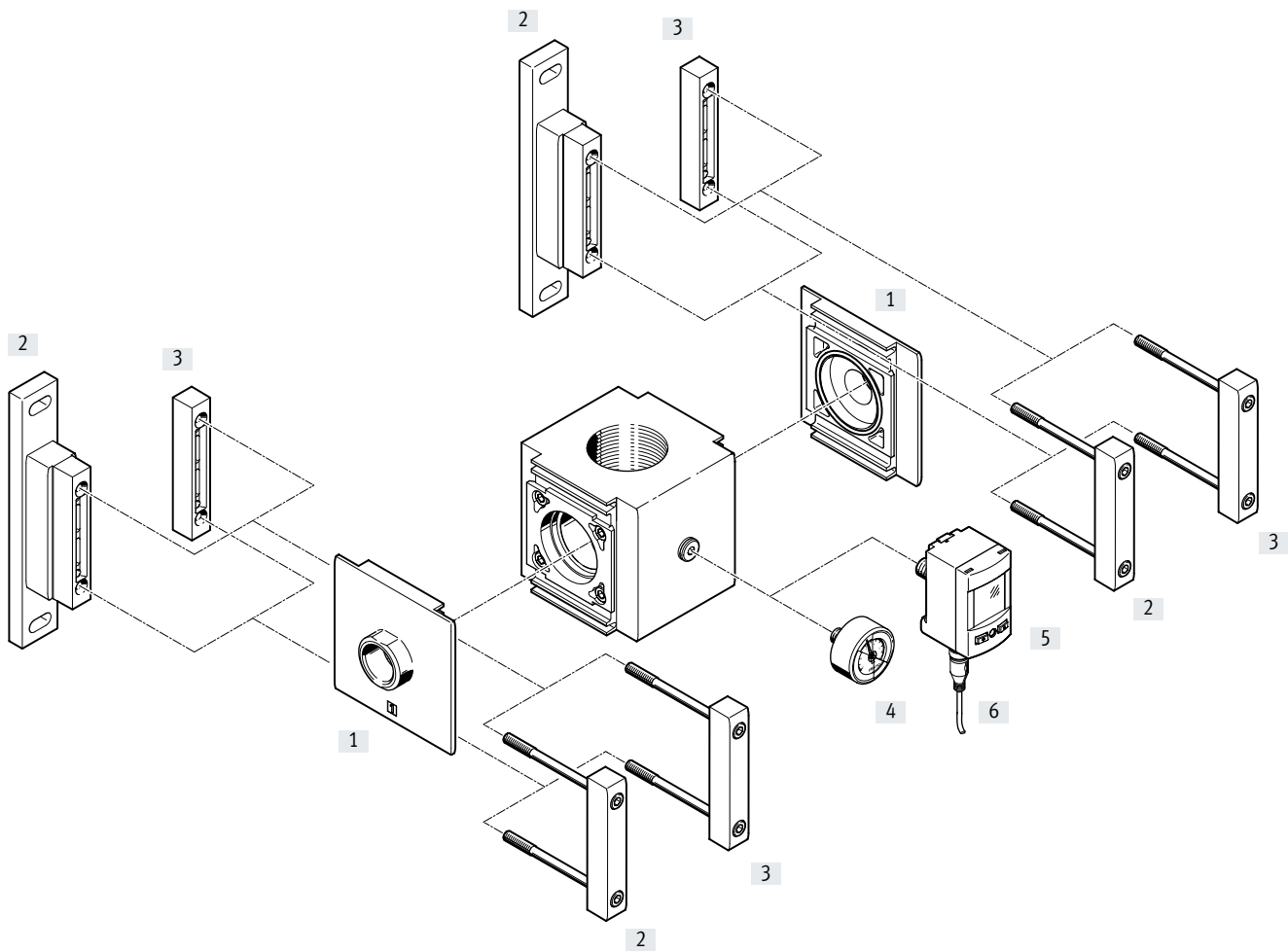

Note
 Additional accessories:
 • Module connector for combination with size MS9
 → Internet: armv

Mounting attachments and accessories		Order code	→ Page/Internet
Can be ordered via the modular product system			
[1]	Connecting plate SET ¹⁾	[AG...]	35
[2]	Mounting bracket	[WP]	
Can be ordered as accessories			
[1]	Connecting plate SET	MS12-AG...	ms12-ag
[2]	Mounting bracket	MS12-WP	ms12-wp
[3]	Module connector	MS12-MV	ms12-mv
[4]	Pressure gauge	MA...-G1/4, MA...-R1/4	36
[5]	Pressure sensor	SPAU...-TR14M	36
[6]	Connecting cable	NEBU-M8...-LE4, NEBU-M12...-LE4	37

1) Module connector [3] is included in the scope of delivery.

Type codes

001	Series
MS	MS series

002	Size
12	Grid dimension 124 mm

003	Function
FRM	Branching module





004	Pneumatic connection
AGF	Sub-base G1
AGG	Sub-base G1 1/4
AGH	Sub-base G1 1/2
AGI	Sub-base G2
G	Module without connecting thread, without sub-base

005	Type of mounting
	Without mounting bracket
WP	Mounting bracket basic design

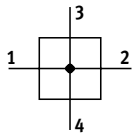
Datasheet

Function



-  - Flow rate
25000 ... 42000 l/min
-  - Temperature range
-10 ... +60°C
-  - Operating pressure
0 ... 20 bar
-  - www.festo.com



- Compressed air distributors with 4 connections
- Attachment option for auxiliary modules
- Outlet at the top and underneath
- Can be used as an intermediate distributor for varying air qualities

General technical data

Pneumatic connection 1, 2	
Connecting plate [AG...]	G1, G1 1/4, G1 1/2 or G2
Module without connecting thread/connecting plate [G]	-
Pneumatic connection 3	G2
Pneumatic connection 4	G1
Design	Branching module
Type of mounting	With accessories In-line installation
Mounting position	Any

† Note: This product conforms to ISO 1179-1 and ISO 228-1.

Standard nominal flow rate $q_{nN}^{1)}$ [l/min]

In main flow direction 1 → 2	25000 ... 42000
------------------------------	-----------------

1) Dependent on the connecting plate selected. Must be ordered separately as an accessory → Internet: ms12-ag
Measured at $p_1 = 6$ bar and $p_2 = 5$ bar, $\Delta p = 1$ bar.

Operating and environmental conditions

Operating pressure [bar]	0 ... 20
Operating medium	Compressed air to ISO 8573-1:2010 [--:--]
Ambient temperature [°C]	-10 ... +60
Temperature of medium [°C]	-10 ... +60
Storage temperature [°C]	-10 ... +60
Corrosion resistance class CRC ¹⁾	2

1) Corrosion resistance class CRC 2 to Festo standard FN 940070
Moderate corrosion stress. Indoor applications in which condensation can occur. External visible parts with primarily decorative surface requirements which are in direct contact with a normal industrial environment.

Datasheet

Weights [g]

Branching module	3000
------------------	------

Materials

Sectional view

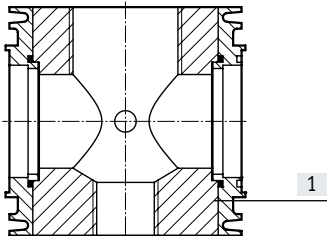

Branching module

[1] Housing	Die-cast aluminium
- Seals	NBR
- Connecting plate, module connector, mounting bracket	Die-cast aluminium
	Free of copper and PTFE

Dimensions – Basic version

Download CAD data → www.festo.com

[G] Module without connecting thread, without connecting plate

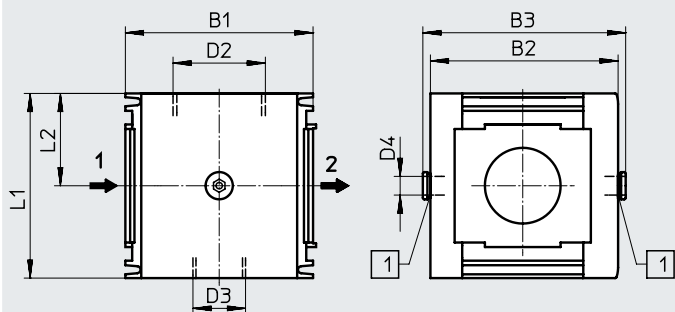

[1] Female thread G1/4 in housing, sealed with plug screw as standard

→ Flow direction

Type	B1	B2	B3	D2	D3	D4	L1	L2
MS12-FRM-G	124	124	134	G2	G1	G1/4	122	61

† Note: This product conforms to ISO 1179-1 and ISO 228-1.

Ordering data

Size	Port 1, 2	Port 3, 4	Flow direction	Part no.	Type
MS12	Without connecting thread	G thread	From left to right	541681	MS12-FRM-G



Ordering data – Modular product system

Ordering table		Grid dimension	[mm]	124	Conditions	Code	Enter code
Module no.		535035					
Series		Standard				MS	MS
Size		12				12	12
Function		Branching module				-FRM	-FRM
Pneumatic connection		Connecting plate G1				-AGF	
		Connecting plate G1 1/4				-AGG	
		Connecting plate G1 1/2				-AGH	
		Connecting plate G2				-AGI	
		Module without connecting thread, without connecting plate				-G	
Type of mounting		Without mounting bracket					
		Mounting bracket standard design			[1]	-WP	

[1] WP Only with connecting plate AGF, AGG, AGH or AGI.

Accessories

Ordering data – Pressure gauge MA						
	Nominal size	Pneumatic connection	Display range		Part no.	Type
			[bar]	[psi]		
	Pressure gauge MA, EN 837-1 Datasheets → Internet: ma					
	40	R1/4	0 ... 16	0 ... 232	187080	MA-40-16-R1/4-EN
		G1/4	0 ... 16	0 ... 232	183901	MA-40-16-G1/4-EN
	Pressure gauge MA, EN 837-1, with red/green range Datasheets → Internet: ma					
40	R1/8	0 ... 16	–	525726	MA-40-16-R1/8-E-RG	
50	R1/4	0 ... 16	–	525729	MA-50-16-R1/4-E-RG	

Ordering data – Pressure sensor SPAU						
	Pneumatic connection	Display type	Switching output	Electrical connection	Part no.	Type
	Male thread R1/8	Illuminated LCD	2x PNP or 2x NPN switchable	M8x1, 4-pin	8001203	SPAU-P10R-T-R18M-L-PNLK-PNVBA-M8D
				M12x1, 4-pin	8001206	SPAU-P10R-T-R18M-L-PNLK-PNVBA-M12D
	Male thread R1/4			M8x1, 4-pin	8001209	SPAU-P10R-T-R14M-L-PNLK-PNVBA-M8D
				M12x1, 4-pin	8001208	SPAU-P10R-T-R14M-L-PNLK-PNVBA-M12D
Order code from modular product system [AD11]/[AD12]: For mounting on flange, pressure measuring range 0 ... 10 bar, relative pressure measurement						
	Flange MS4	Illuminated LCD	2x PNP or 2x NPN switchable	M8x1, 4-pin	8035302	SPAU-P10R-MS4-F-L-PNLK-PNVBA-M8D
				M12x1, 4-pin	8035304	SPAU-P10R-MS4-F-L-PNLK-PNVBA-M12D
	Flange MS6			M8x1, 4-pin	8035303	SPAU-P10R-MS6-F-L-PNLK-PNVBA-M8D
				M12x1, 4-pin	8074906	SPAU-P10R-MS6-F-L-PNLK-PNVBA-M12D

Ordering data – Electrical adapter SASC						
	Description	Electrical connection	Part no.	Type		
	For pressure sensor SPAN	M8x1, 4-pin	8000326	SASC-P4-A-M8-A		

Ordering data – Pressure sensor SPAN						
	Pneumatic connection	Display type	Switching output	Analogue output	Part no.	Type
	Male thread G1/8	Illuminated LCD	2x PNP or 2x NPN switchable	–	★ 8035544	SPAN-P10R-G18M-PN-PN-L1
				0 ... 10 V, 0 ... 5 V, 4 ... 20 mA	8035533	SPAN-P10R-G18M-PNLK-PNVBA-L1
	Male thread R1/8			–	★ 8035547	SPAN-P10R-R18M-PN-PN-L1
				0 ... 10 V, 0 ... 5 V, 4 ... 20 mA	8035536	SPAN-P10R-R18M-PNLK-PNVBA-L1

Accessories

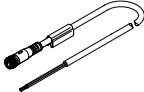
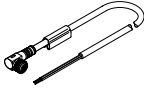
Ordering data – Connecting cable NEBU-M8						Datasheets → Internet: nebu
	Electrical connection	Number of wires	Cable length [m]	Part no.	Type	
	M8x1, straight socket	3	2.5	★ 541333	NEBU-M8G3-K-2.5-LE3	
			5	★ 541334	NEBU-M8G3-K-5-LE3	
		4	2.5	541342	NEBU-M8G4-K-2.5-LE4	
			5	541343	NEBU-M8G4-K-5-LE4	
	M8x1, angled plug socket	3	2.5	★ 541338	NEBU-M8W3-K-2.5-LE3	
			5	★ 541341	NEBU-M8W3-K-5-LE3	
		4	2.5	541344	NEBU-M8W4-K-2.5-LE4	
			5	541345	NEBU-M8W4-K-5-LE4	

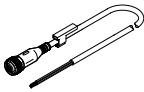
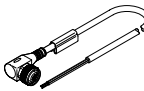
Ordering data – Connecting cable NEBU-M12						Datasheets → Internet: nebu
	Electrical connection	Number of wires	Cable length [m]	Part no.	Type	
	M12x1, straight socket	3	2.5	★ 541363	NEBU-M12G5-K-2.5-LE3	
			5	★ 541364	NEBU-M12G5-K-5-LE3	
		4	2.5	★ 550326	NEBU-M12G5-K-2.5-LE4	
			5	★ 541328	NEBU-M12G5-K-5-LE4	
	M12x1, angled plug socket	3	2.5	541367	NEBU-M12W5-K-2.5-LE3	
			5	541370	NEBU-M12W5-K-5-LE3	
		4	2.5	550325	NEBU-M12W5-K-2.5-LE4	
			5	541329	NEBU-M12W5-K-5-LE4	

Ordering data – Angled plug socket PEV						Datasheets → Internet: pev-1/4
	Description	Operating voltage range	Electrical connection	Switching status indication	Part no.	Type
	For PEV-1/4-...-OD	15 ... 30 V DC	4-pin	Yellow LED	164274	PEV-1/4-WD-LED-24
		≤ 230 V AC ≤ 180 V DC	4-pin	Yellow LED	164275	PEV-1/4-WD-LED-230

Ordering data – Plug socket MSSD						Datasheets → Internet: mssd-c-4p
	Description	Operating voltage range	Electrical connection	Type of mounting for cable connection	Part no.	Type
	For PEV-1/4-...-OD	≤ 250 V AC/DC	3-pin	Clamping screws	171157	MSSD-C-4P

Ordering data – Double nipple ESK					
	Description	Pneumatic connection		Part no.	Type
	For subsequent mounting of pressure switch PEV on branching module MS-FRM	R1/4	R1/4	151521	ESK-1/4-1/4
			R1/2	534153	ESK-1/4-1/2