

Technical catalogue



CERTIFICATO ◆ CERTIFICADO ◆ CERTIFIKAT ◆ 認證證書 ◆ CERTIFICATE ◆ ZERTIFIKAT



CERTIFICATO

Nr. 50 100 4121 Rev.007

SI ATTESTA CHE / THIS IS TO CERTIFY THAT

IL SISTEMA DI GESTIONE PER LA QUALITÀ DI
THE QUALITY MANAGEMENT SYSTEM OF



AIRCUM S.r.l.

SEDE LEGALE E OPERATIVA:
REGISTERED OFFICE AND OPERATIONAL SITE:
**VIA TRATTATO DI MAASTRICHT SNC
IT - 15067 NOVI LIGURE (AL)**

È CONFORME AI REQUISITI DELLA NORMA
HAS BEEN FOUND TO COMPLY WITH THE REQUIREMENTS OF
UNI EN ISO 9001:2015

QUESTO CERTIFICATO È VALIDO PER IL SEGUENTE CAMPO DI APPLICAZIONE
THIS CERTIFICATE IS VALID FOR THE FOLLOWING SCOPE OF APPLICATION:

Progettazione e fabbricazione di tubi, raccordi ed accessori in materiale termoplastico e tecnopolimero per la distribuzione di aria compressa e fluidi; progettazione di raccordi in alluminio. Commercializzazione di tubi in alluminio, valvole e accessori per la distribuzione di aria compressa (AF 14, 29).

Design and manufacturing of pipes, fittings and accessories in thermoplastic and technopolymer material for compressed air and fluid distribution; design of aluminium fittings. Trade of aluminium pipes, valves and accessories for compressed air distribution (AF 14, 29)

Per l'Organismo di Certificazione For the Certification Body TUV Italia S.r.l.	Validità / Validity Dal / From: 2021-12-04 Al / To: 2024-12-03
ACCREDIA SOG N° 045A <small>Member of the Accredited Bodies Recognition System AI, AF, A1, A2 Numero PTA, AF, A1/A2/A3/A4/A5 Registration Agreement</small>	Data emissione / Issuing Date  Francesco Scialata <small>Divisione Sistemi Business Resources Business Resource Division Manager</small>

PRIMA CERTIFICAZIONE / FIRST CERTIFICATION: 2004-03-16

*LA VALIDITÀ DEL PRESENTE CERTIFICATO È SUBORDINATA A SOGGIEZIONE PERIODICA E SI NEDE E AL RESUME COMPLETO DEL SISTEMA DI GESTIONE PER LA QUALITÀ. *THE VALIDITY OF THE PRESENT CERTIFICATE DEPENDS ON THE ANNUAL SURVEILLANCE EXERCISES AND ON THE COMPLETE REVIEW OF COMPANY'S MANAGEMENT SYSTEMS AT THE DUE DATES.

TUV Italia • Gruppo TÜV SÜD • Via Carducci 125, Pal. 23 • 20098 Sette San Giovanni (MI) • Italia • www.tuvitalia.com/it **TUV®**

CERTIFICATO ◆ CERTIFICADO ◆ CERTIFIKAT ◆ 認證證書 ◆ CERTIFICATE ◆ ZERTIFIKAT



CERTIFICATO

Nr. 50 100 16124

SI ATTESTA CHE / THIS IS TO CERTIFY THAT

IL SISTEMA DI GESTIONE SICUREZZA E SALUTE DEI LAVORATORI DI
THE OCCUPATIONAL HEALTH AND SAFETY MANAGEMENT SYSTEM OF



AIRCUM S.r.l.

SEDE LEGALE E OPERATIVA:
REGISTERED OFFICE AND OPERATIONAL SITE:
**VIA TRATTATO DI MAASTRICHT SNC
IT - 15067 NOVI LIGURE (AL)**

È CONFORME AI REQUISITI DELLA NORMA
HAS BEEN FOUND TO COMPLY WITH THE REQUIREMENTS OF
UNI ISO 45001:2018

QUESTO CERTIFICATO È VALIDO PER IL SEGUENTE CAMPO DI APPLICAZIONE
THIS CERTIFICATE IS VALID FOR THE FOLLOWING SCOPE:

Progettazione e fabbricazione di tubi, raccordi ed accessori in materiale termoplastico e tecnopolimero per la distribuzione di aria compressa e fluidi; mediante le fasi di stampaggio ad iniezione, assemblaggio e imballaggio. Commercializzazione di tubi in alluminio, valvole e accessori per la distribuzione di aria compressa; mediante le fasi di assemblaggio e imballaggio (AF 14, 29).

Design and manufacture of thermoplastic and techno polymer pipes, fittings and accessories for the distribution of compressed air and fluids; through the of injection molding, assembly and packaging phases. Trade of aluminium pipes, valves and accessories for compressed air distribution; through the assembly and packaging phases (AF 14, 29)

Per l'Organismo di Certificazione For the Certification Body TUV Italia S.r.l.	Validità / Validity Dal / From: 2021-05-04 Al / To: 2024-05-03
ACCREDIA SCR N° 009F <small>Member of the Accredited Bodies Recognition System AI, AF, A1, A2 Numero PTA, AF, A1/A2/A3/A4/A5 Registration Agreement</small>	Data emissione / Issuing Date  Andrea Coscia <small>Divisione Sistemi Business Resources Business Resource Division Manager</small>

PRIMA CERTIFICAZIONE / FIRST CERTIFICATION: 2004-03-16

*LA VALIDITÀ DEL PRESENTE CERTIFICATO È SUBORDINATA A SOGGIEZIONE PERIODICA E SI NEDE E AL RESUME COMPLETO DEL SISTEMA DI GESTIONE PER LA SICUREZZA E SALUTE DEI LAVORATORI. *THE VALIDITY OF THE PRESENT CERTIFICATE DEPENDS ON THE ANNUAL SURVEILLANCE EXERCISES AND ON THE COMPLETE REVIEW OF COMPANY'S MANAGEMENT SYSTEMS AT THE DUE DATES.

TUV Italia • Gruppo TÜV SÜD • Via Carducci 125, Pal. 23 • 20098 Sette San Giovanni (MI) • Italia • www.tuvitalia.com/it **TUV®**

TABLE OF CONTENTS

INTRODUCTION to AIRCOM Product Range

ANNEX A

Assembly Instructions

ANNEX B

Quick Line Aluminium - Technical Data Sheets

ANNEX C

Quick Line HR-Polymer - Technical Data Sheets

The information contained in these documents is based on science and knowledge and represents the current state-of-the-art. The information, data and images of Aircom Srl products shown herein are provided without obligation and are for guidance purposes only. We reserve the right to make technical modifications without prior notice. We recommend that users always check the suitability of products for the applications involved. The reproduction or partial reproduction of these documents is forbidden without written consent from Aircom Srl.

All rights reserved.
(S. E. & O.)

PRODUCT RANGE

Constant development, expansion and changes to production layouts in factories and the evolution of production technologies, especially towards automation, calls for compressed air distribution systems that are appropriately sized and easily modified.

The AIRCOM QUICK LINE system was designed and created specifically for constructing compressed air and pressurised fluid distribution systems.

QUICK LINE ALUMINIUM AND HR-POLYMER

Choosing quality compressed air products means eliminating the typical costs incurred in managing the obsolete systems that are still in use. It also lets buyers choose from a huge range with the knowledge that such quality products have been fully tested and certified in compliance with current legislation.

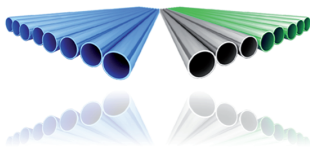

Aluminium Pipe

Diameter Ø

16 - 20 - 25 - 32 - 40 - 50
63 - 80 - 110 - 168,3 - 220 mm

Materials

AN AW 6060 T6 aluminium alloy
with internal and external
fluotitanation treatment

Markings

- Product line
- External Dia. - Internal Dia.
- P. Max in BAR
- P. Max in PSI
- Production batch



Aluminium Fittings

Diameter Ø

20 - 25 - 32 - 40
50 - 63 - 80 - 110 mm

Nut & Body

Aluminium alloy EN-AB 46100
Standards UNI-EN 1676

Clamping ring

Stainless steel X10CrNi18-8
UNI-EN 10088

Gasket

NBR 70
UNI ISO 3601

Conical ring

- HR Polymer 6
- ISO 1043



HR-Polymer Fittings

Diameter Ø

16 - 20 - 25 - 32
40 - 50 - 63 mm

Nut & Body

Alloy HR Polymer
Standards ISO 1043

Clamping ring

Stainless steel X10CrNi18-8
UNI-EN 10088

Gasket

NBR 70
UNI ISO 3601

Marking

- Diameter
- Date

LARGE SIZES

The new 168,3 mm (6") family, is the largest diameter size in AIRCOM, at present.

A perfect solution for compressor rooms, large piping networks and distribution mains!

ACCESSORIES

The vast range of accessories will allow you, not only to operate in complete safety, but also to speed up installation work and plant maintenance. The Accessories range include a set of equipment specifically designed for the Quick Line Aluminium, the Quick Line HR-Polymer and the Evo Line systems, resulting in rapid, professional assembly.

Thanks to the new multilayer pipe, you can shape pipe sections in problematic areas, overcoming obstacles in the easiest, fastest way possible. Assembly is done professionally and rapidly with the complete range of screw nut wrenches and dedicated tools.



Large sizes 80 - 110 mm



Large sizes 168,3/220 mm (6"/8")



Common Accessories

Diameter Ø

80 - 110 mm

Nut & Body

Aluminium alloy EN-AB 46100
Standards UNI-EN 1676

Tightening ring

Stainless steel X10CrNi18-8
UNI-EN 10088

Gasket

NBR 70
UNI ISO 3601

Conical ring

- HR Polymer 6
- ISO 1043

Diameter Ø

168,3 - 220 mm

Fittings Body

Aluminum
ASTM B-26, 356-T6 alloy.

Coupling

Galvanized ductile iron
ASTM A 536, Grade 65-45-12.

Gasket

Nitrile

Diameter Ø

16 - 20 - 25 - 32 - 40 - 50
63 - 80 - 110 - 168,3 - 220 mm

Brackets

PP
Polypropylene

Quick Line nut wrench

PA6
Polyamide 6

Multilayer pipe

PE-RT (internal layer)
Adhesive layer
Aluminium layer overlapped
and ultrasonic welded
Adhesive layer
PE-RT (external layer)

FIELDS OF APPLICATION

COMPRESSED AIR

The AIRCOM QUICK LINE system was designed mainly for the transportation and distribution of COMPRESSED AIR at pressures of up to 16 bar.

The wide range of products available means that plant equipment units can be created that start from the air production and treatment unit then go on to the distribution loop and all the peripheral take-offs. A series of special items quickly and efficiently deals with all the specific problems of installation normally associated with compressed air.

The AIRCOM QUICK LINE system integrates perfectly with the whole AIRCOM product line, such as the CLASSIC line.

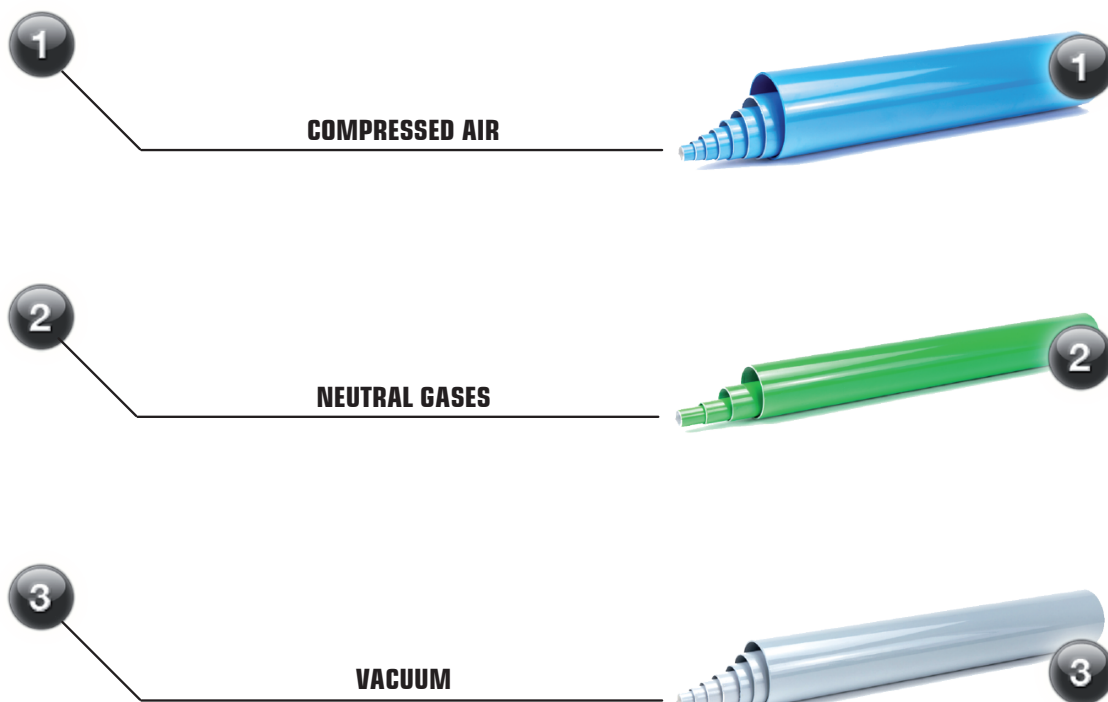

The ease and speed with which the Quick Line system can be assembled is the direct result of innovative technology which allows the instant connection of components to aluminium pipes.

This technology takes into account all diameters and all types of joints and fittings to offer the user safety from any potential stress.

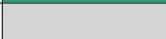

DISTINCTIVE PIPE COLOURING SYSTEM

The colour identification system for bare pipes and ducting is described in detail in UNI 5634 - 97.

Fluid	ID color	RAL code
Neutral gases		6032
Vacuum		7001
Compressed air		5012

SAFETY

REACTION TO FIRE

All AIRCOM components are self-extinguishing and do not propagate flames
Pipes, fittings:

EN13501-1:2007 + A1:2009
EN ISO 11925-2:2010
EN ISO 13823:2010

SYSTEM VERSATILITY

AIRCOM products have been specifically studied and designed to create complete systems for the distribution of compressed air and pressurised fluids. Thanks to their versatility, they can be connected to already existing plant units.

CE CONFORMITY

All our products comply with 97/23/EC

TEN-YEAR GUARANTEE

In line with high quality performance of its product range, AIRCOM offers a ten-year guarantee on materials.

To read the Terms of Cover of the guarantee, refer to the Technical Catalogue.



AIRCOM TECHNOLOGY - Quick, Easy & Reliable!

A modern, high technology & high performance systems, flexible in its application, to expand and grow together with your factory!

AIRCOM is the only producer offering a complete range of systems differentiated by features and performance. Innovative technology at the heart of AIRCOM fittings, enables rapid and easy assembly: quick connection of components to the aluminium pipe.

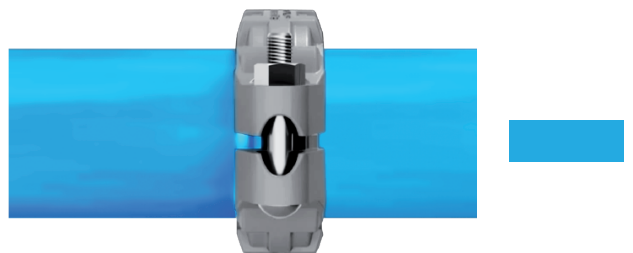
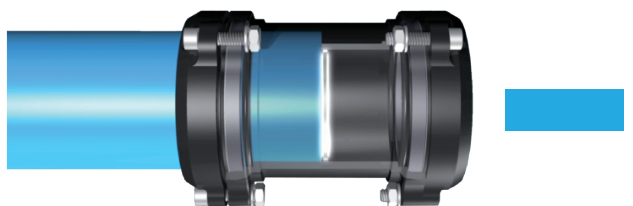
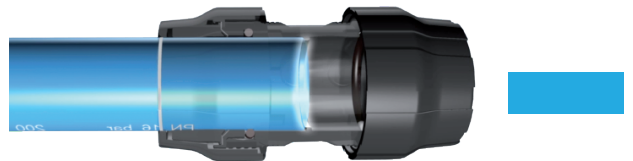
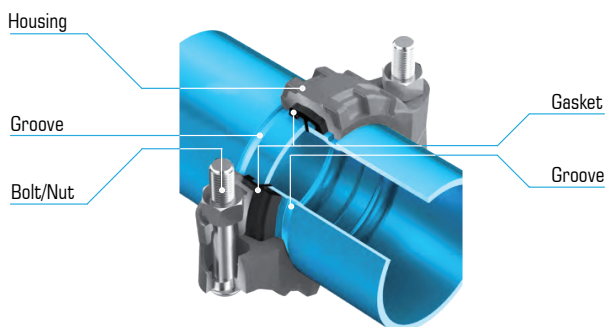
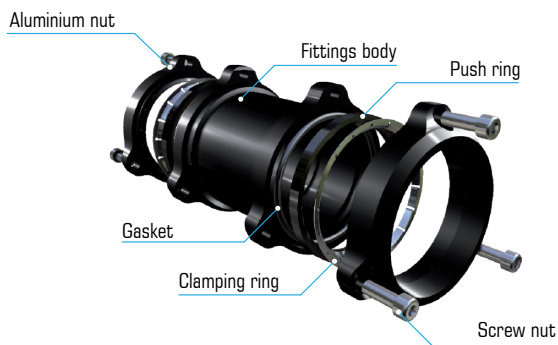
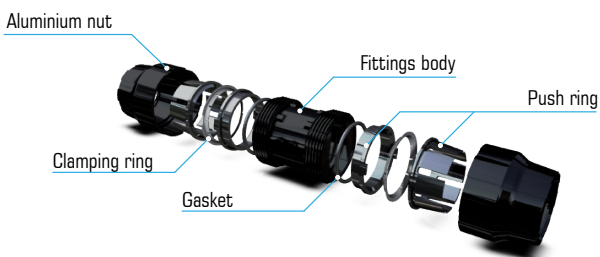
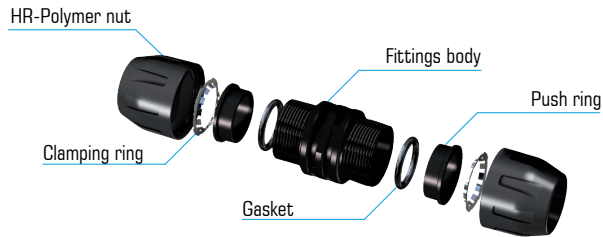

QUICK LINE SYSTEM

A twin, modular piping system with outstanding features in terms of speed and ease of assembly:

- > Quick Line Aluminium System: aluminium pipes with aluminium fittings
- > Quick Line HR-Polymer System: aluminium pipes with HR-Polymer fittings

The peculiar, great insertion depth of pipe inside of fittings contributes to a more reliable alignment of pipes and fittings, improved structural cooperation and stronger grip on the pipe.

QUICK LINE HR-POLYMER

A complete system of aluminium pipes with fittings in HR-Polymer.

The HR-Polymer fittings come in following diameters:

16-20-25-32-40-50-63 mm

The entire range of threaded fittings is available both with GAS and NPT thread.

QUICK LINE ALUMINIUM

A complete system of pipes and fittings in aluminium.

The die-cast aluminium fittings come in following diameters: **20-25-32-40-50-63-80 mm**

The entire range of threaded fittings is available both with GAS and NPT thread.

QUICK LINE ALUMINIUM 110 mm (4")

A complete range of pipes and fittings in aluminium, diameter size **110 mm**

Same technology as the a smaller sizes but adapted to the large size of 110 mm / 4".

The entire range of threaded fittings is available both with GAS and NPT thread.

A perfect solution for medium-size compressor rooms, large piping networks and distribution mains!

QUICK LINE ALUMINIUM 168.3 mm (6") / 220 mm (8")

A complete range of aluminium pipes with special fittings, diameter size

168.3 mm (6") / 220 mm (8") Pipes coming with already pre-grooved ends.

The entire range of threaded fittings is available both with GAS and NPT thread.

A perfect solution for compressor rooms, large piping networks and distribution mains!

SPECIFICATIONS FOR QUICK LINE ALUMINIUM & POLYMER

The fittings and joints allow for the creation of systems that can resolve the problems and requirements associated with more complex plant units.

Speed of installation, a perfect airtight seal, significant mechanical resistance and efficiency over time are the hallmark of AIRCOM products.



CORROSION

The hot electro-plating system used for aluminium alloy pipes eliminates problems of corrosion and degradation of internal and external surfaces. It means that the product has a guaranteed lifespan of at least 50 years under normal conditions of use.



MECHANICAL BEHAVIOUR

The materials used in the system guarantee excellent performance characteristics in terms of mechanical resistance, internal pressure and resistance to external impacts. Pipes can also cope with violent impacts and shock with no danger.



ULTRAVIOLET RAYS

Aluminium does not suffer when exposed to ultraviolet rays meaning that it can be used both indoors and out.



FIRE RESISTANCE

Aluminium has excellent fire resistance properties and neither feeds nor propagates fire.



FLOW RATE

The AIRCOM QUICK LINE system offers excellent flow rates per diameter due to the low coefficient of friction, the wide cross section of the pipes and the absence of internal hindrances or areas where the pipes becomes narrower.



SIZE CHARACTERISTICS AND STANDARDS

All the components in the AIRCOM QUICK LINE system comply with national and international standards regarding pipes for pressurised fluids.



COMPATIBILITY WITH OILS FOR COMPRESSORS

Aluminium, like the technopolymers from which the AIRCOM QUICK LINE system is made, do not present any particular problems on contact with lubricants for compressors.

MATERIAL CHARACTERISTICS

MATERIALS USED AND REFERENCE STANDARDS



QUICK LINE	MATERIAL	REFERENCE STANDARDS
Aluminium pipe	EN AW 6060 T6 aluminium alloy with internal and external fluorination treatment	UNI-EN 755-2
Ring nuts up to dia. 50 PA	Polyamide 6 Diam.16 - 63	ISO 1043
Ring nuts larger than dia. 50 AL	EN-AB 46100 aluminium alloy	UNI-EN 1676
Bodies up to dia. 50 PA	Polyamide 6	ISO 1043
Bodies larger than dia. 50 AL	EN-AB 46100 aluminium alloy	UNI-EN 1676
Push ring	Polyamide 6	ISO 1043
Clamping ring	X10CrNi18-8 stainless steel	UNI-EN 10088
Gaskets	NBR 70 (Viton® on request)	UNI ISO 3601
Flexible hoses	-	-
Quick Line ball valves	-	-
Aluminium bodies and joint	EN-AB 46100 aluminium alloy	UNI-EN 1676
Brass bodies and joint	CW 617N brass alloy	UNI-EN 12165
Threaded inserts	Polyamide 6	ISO 1043
Applique bodies AL	EN AW 6063 T66 aluminium alloy	UNI-EN 755-2
Quick branch droplet bodies	Polyamide 6	ISO 1043
Brackets	Polypropylene	ISO 1043
M8 screw-bolts	Galvanised steel	UNI-EN-ISO 4032
Spacers	Polypropylene	ISO 1043
Bracket systems	Galvanised steel	-

TYPICAL PHYSICAL AND MECHANICAL FEATURES OF ALUMINIUM EN AW 6060 T6 ALUMINIUM ALLOY



CHARACTERISTIC	VALUE	NOTES
Metallurgical state	T6	-
Density	2,7 Kg/dm ³	-
Elastic modulus	69 KN/mm ²	-
Coeff. of thermal expansion	23 µm/m°C	from 20° to 100°C
Thermal conductivity	200 W/(m·K)	a 20°C
Specific heat	880 ÷ 900 J/(Kg·K)	from 0° to 100°C
Melting point	600 ÷ 660 °C	-
Tensile strength Rm	190 N/mm ²	Minimum
Yield strength Rp	150 N/mm ²	Minimum
Elongation A %	8	Minimum
Elongation A (50mm) %	6	Minimum



DESIGN AND QUALITY CONTROL

AIRCOM products come under the aegis of Made in Italy, and product quality is therefore of the very highest standard. The Company has numerous departments dedicated to specific activities for the Quality Control.

QUALITY CONTROL TEST

- Mould controls
- Size controls / Size tests
- Pneumatic leak tests at **PN 16 bar**
- Resistance factor 4
- Polymer ageing tests at **64 bar**
- Resistance tests at up to **120 bar**
- Pressure tests with compressed air
- Pressure tests with water

**Product conforms or does not conform before
being released to market.**

COMPRESSED AIR PURITY CLASSES

The levels of purity for each contaminant are usually shown separately; this document combines all three contaminant in an easily read single table.

PURITY CLASSES	Solid particulate			Concentration of mass mg/m ³	Water		Oil
	Number of particles per m ³				Dewpoint	Liquid g/m ³	Total oil (aerosol, liquid and vapour)
	0.1 – 0.5 μm	0.5 – 1 μm	1 – 5 μm				mg/m ³
0	As specified by the user or by the equipment supplier is more rigid than Class 1						
1	≤ 20,000	≤ 400	≤ 10	-	≤ - 70°C	-	0.01
2	≤ 400,000	≤ 6,000	≤ 100	-	≤ - 40°C	-	0.1
3	-	≤ 90,000	≤ 1,000	-	≤ - 20°C	-	1
4	-	-	≤ 10,000	-	≤ + 3°C	-	5
5	-	-	≤ 100,000	-	≤ + 7°C	-	-
6	-	-	-	≤ 5	≤ + 10°C	-	-
7	-	-	-	5-10	-	≤ 0.5	-
8	-	-	-	-	-	0.5 - 5	-
9	-	-	-	-	-	5 - 10	-
10	-	-	-	> 10	-	> 10	> 10

EQUIVALENT LENGTHS AND SELECTION OF THE RIGHT DIAMETER

The table below shows the sizes in metres of every fittings.

The equivalent length that comes from the sum of the joints is then added to the average length of pipe used.

Every fittings used on the plant will slow the flow of air to a certain extent depending on its internal geometry.

To allow the size of plant units to be correctly calculated, AIRCOM have drawn in the table below to show lengths in metres and the values relating to any reduction in speed of the flow of air caused by every type of fittings and main accessory.

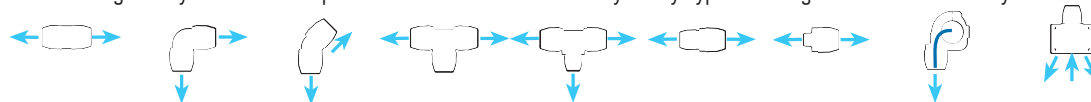

	Couplings	90° Elbows	45° Elbows	Tee	Reduction Tee	Reduction	Nipple	Droplet	Manifolds
16	0,1	0,7	-	0,1	-	-	0,1	-	0,8
20	0,2	1,2	1	0,2	1,3	-	0,2	-	1,2
25	0,2	1,5	1,2	0,3	1,8	0,5	0,2	1,8	1,5
32	0,3	2	1,3	0,3	2,4	0,6	0,3	2,4	-
40	0,3	2,4	1,6	0,4	3	0,7	0,3	3	-
50	0,4	3	2	0,4	4	1	0,4	4	-
63	0,5	3,5	2,5	0,5	4,5	1,5	0,5	4,5	-
80	0,7	4,8	-	0,7	5,5	2	0,7	5,5	-
110	0,8	6	-	0,8	6,5	2,5	-	6,5	-
168,3	-	3	1,5	3	-	-	-	7,6	-
220	-	4,5	3	4,5	-	-	-	10,4	-

LENGTH

Once we know the operating pressure, the rate of flow required and the distance between the compressor and the furthest take off point and taking into consideration the equivalent lengths in metres, we can now calculate the correct sizing of the plant unit.

SELECTING THE OPTIMAL PIPE FOR THE MAIN LOOP

The values refer to a pressure of 8 bar and a maximum pressure drop of 5%

Nm ³ /h	Nm ³ /min	DISTANCE BETWEEN THE COMPRESSOR AND THE FURTHEST TAKE OFF POINT (in m)									
		25	50	100	150	200	300	400	500	1000	
36	600	16	16	20	20	25	25	25	25	32	
54	900	16	20	20	25	25	25	32	32	40	
72	1200	20	25	25	25	32	32	32	32	40	
105	1750	25	25	32	32	32	40	40	40	50	
150	2500	25	32	32	32	40	40	40	50	50	
210	3500	32	32	40	40	40	50	50	50	63	
270	4500	32	32	40	40	50	50	50	50	63	
360	6000	40	40	40	50	50	50	63	63	63	
510	8500	40	40	50	50	50	63	63	63	80	
720	12000	50	50	50	63	63	63	80	80	80	
1080	18000	50	63	63	63	80	80	80	80		
1260	21000	63	63	63	80	80	80	80			
1860	31000	63	80	80	80	80					
2700	45000	80	80	80							
6000	100000	80	110	110							
8100	135000	110	110								
10350	172500	168,3	168,3								
15780	263000	168,3	168,3								
23700	395000	168,3	168,3								
32640	544000	220	220								

If the instant flow rate is equal to or less than that generated by the compressor and the loop is shorter than recommended for a determined pipe diameter, the pressure drop will not exceed 5%. We recommend using larger diameter pipe for potential future developments and to avoid the negative effects caused by the excessive speed of compressed air inside the line.

FLOW RATE AND PRESSURE DROP TABLES

The table below shows the maximum recommended flow rate to prevent excessive speed inside the pipe which can lead to:

- a. an increase in turbulence and subsequent pressure drop;
- b. noise which may exceed the legally allowed limits;
- c. the vaporisation of any condensation present and its spread within the plant unit.

FLOW RATE TABLES

(based on a length of 30 metres)

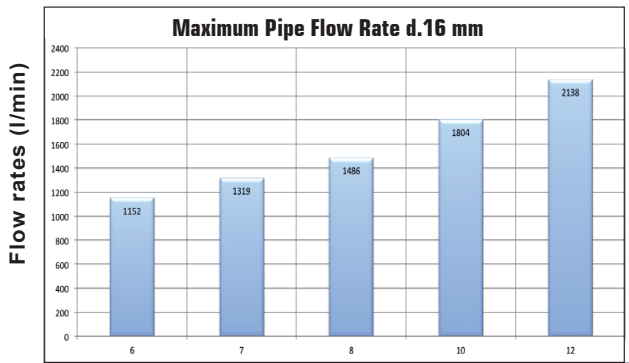

- Table 1a

Bar

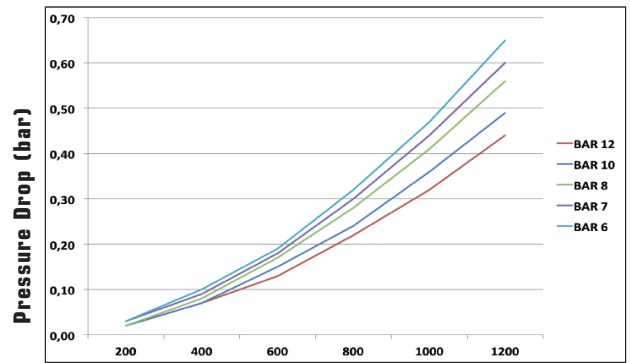

- Table 1b

Consumption It/min

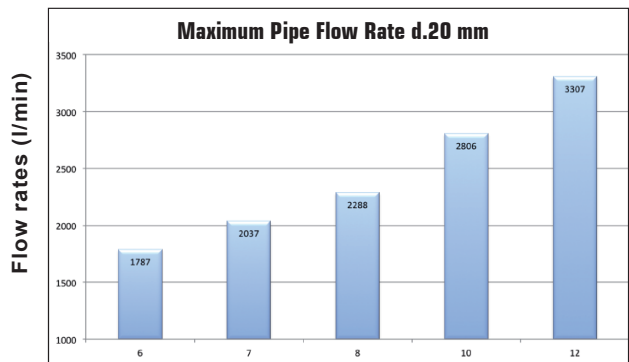

- Table 2a

Bar

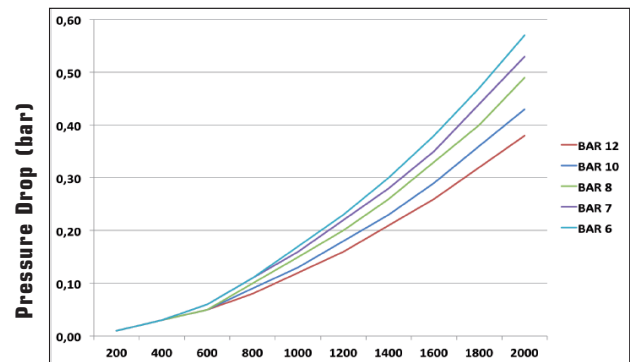

- Table 2b

Consumption It/min

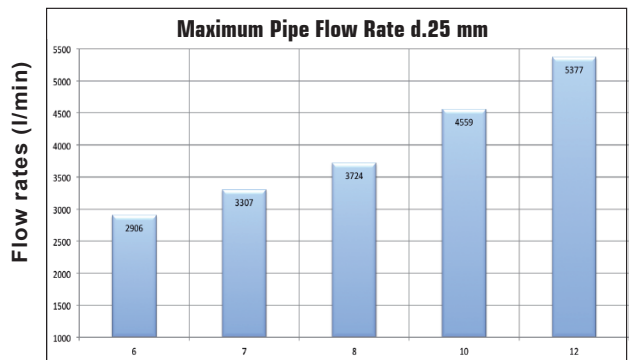

- Table 3a

Bar

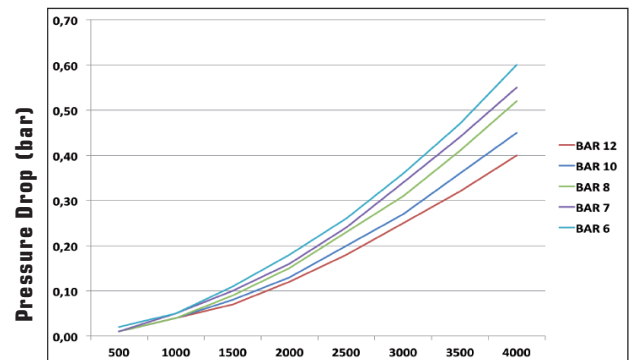

- Table 3b

Consumption It/min

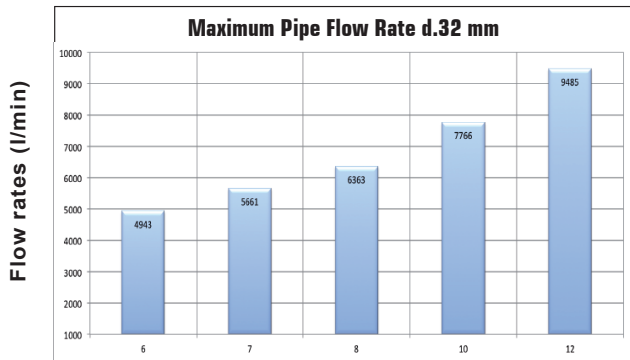

- Table 4a

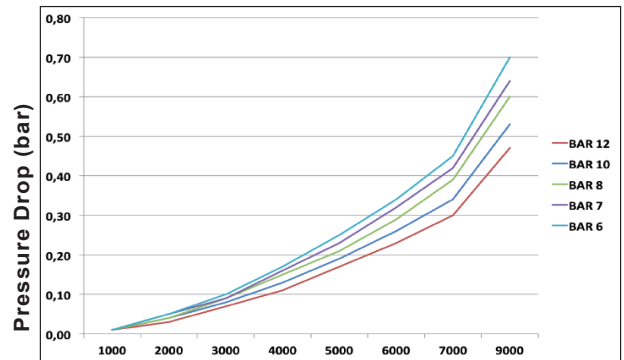

- Table 4b

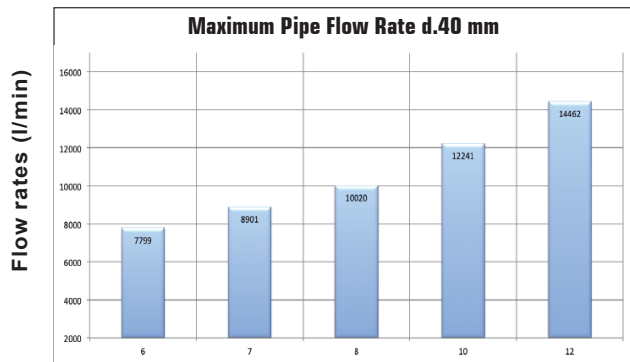

- Table 5a

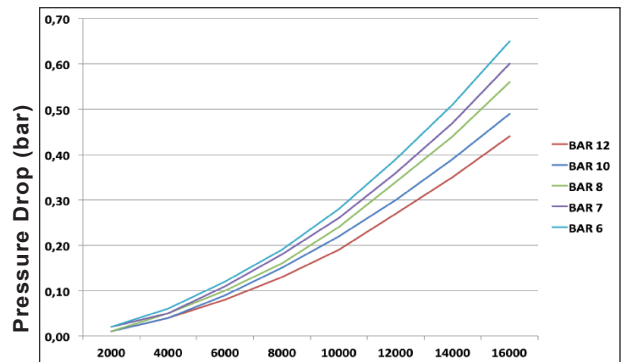

- Table 5b

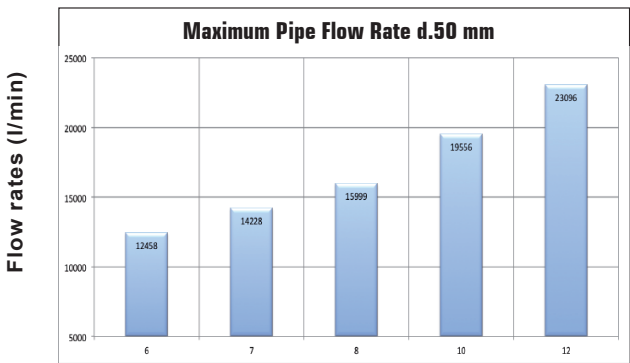

- Table 6a

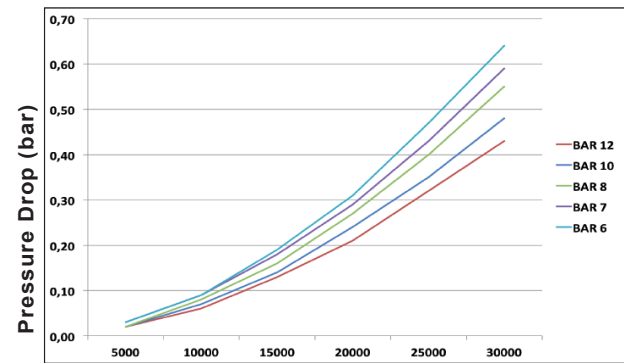

- Table 6b

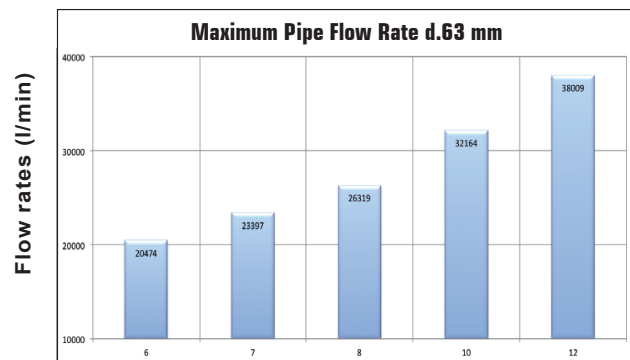

- Table 7a

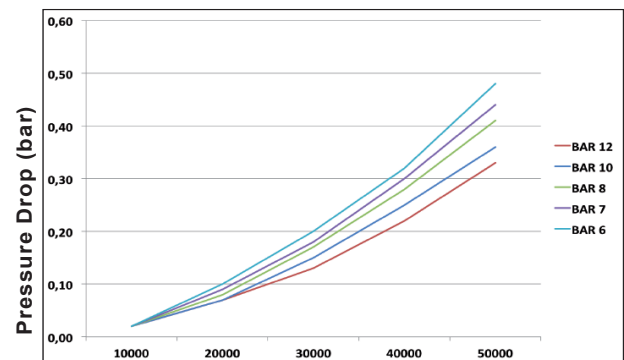

- Table 7b

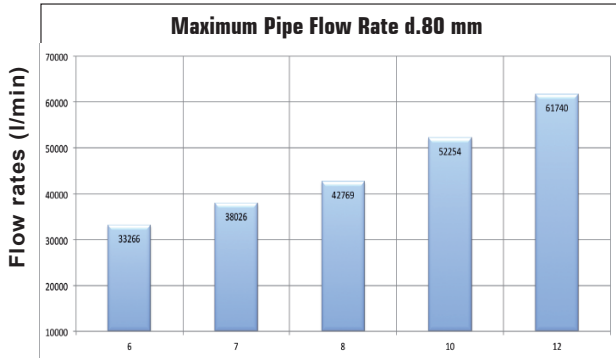

- Table 8a

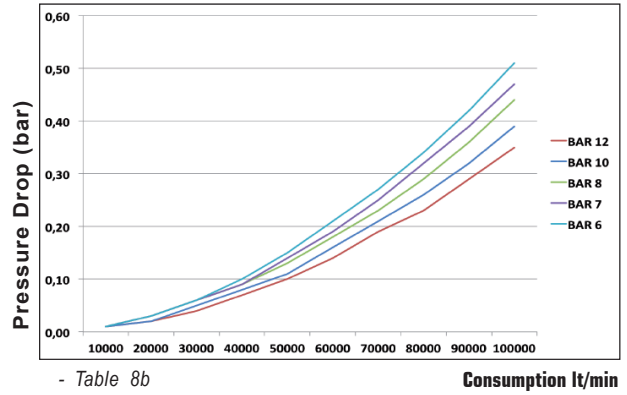

- Table 8b

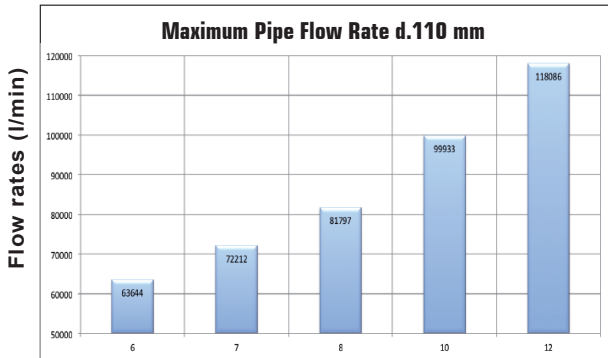

- Table 9a

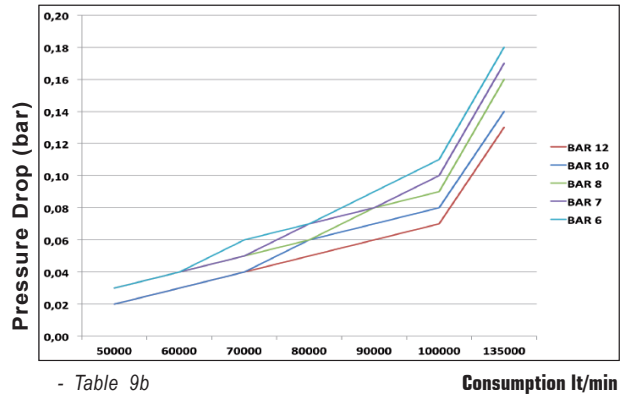

- Table 9b

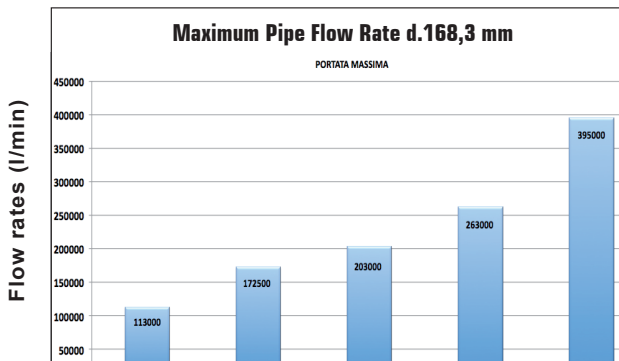

- Table 10a

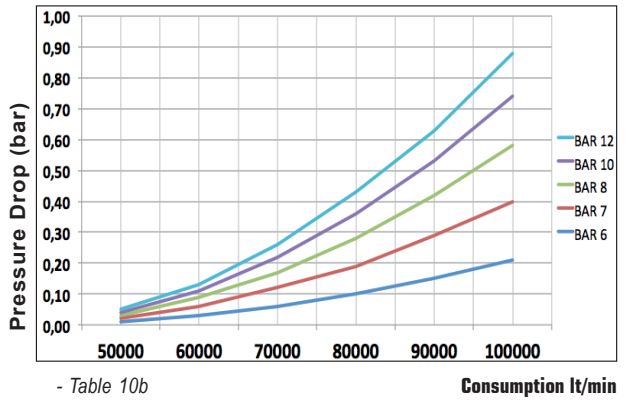

- Table 10b

CERTIFICATIONS AND TREATMENTS - GUARANTEED FOR 10 YEARS



A TÜV certified product guarantees safety and quality. The TÜV Group issues a certificate with the results of tests carried out. This certifies the properties of products and shows the standards that apply to the tests performed.



RINA

A RINA certified product means it has high resistance to external factors. In the case of the Quick Line series, we subjected our Quick Line series products to RINA testing and also obtained certifications for fire resistance.

For further information, contact our Technical Department for the certifications dossier.



AIRCOM products have obtained special T.S.S.A. certification

(Technical Standards & Safety Authority) which sets the different standards specifically required in North America.



AIRCOM products benefit from use of the QUALICOAT brand name which certifies the quality of the paint used to provide excellent characteristics that add to the superior performance properties of our products even under particularly severe environmental operating conditions.



A QUALANOD certified product means safety as regards the process treatments it receives. In effect, the certification relates to the anodising process.

Our products have long life spans thanks to having better resistance to corrosion than our competitors' products.



The ALODINE 400 process provides pipes with an inner and outer coating. This is a titanium, chrome-free process which complies with the ROHS Directive.

Apart from protecting against oxidising, this coating provides better performance characteristics in terms of smoother surfaces inside the pipe meaning a better compressed air flow rates .

DECLARATION OF CONFORMITY AND STANDARDS

The pressurised components (AIRCOM pipes and fittings) were designed to conform with appendix VII of European Directive 97/23/CE) only as regards Article 3.3.



All the pressurised components we manufacture bear our Company name. Conformity assessments and subsequent conformity procedures stipulated by the Directive, have been applied by Aircom to products sold as individual products even if not so required by the Directive (Guide Line 1/9).

PRESSURE CURVE IN RELATION TO TEMPERATURE

The words "Pn 16" mean that AIRCOM Quick Line system products can be used at a maximum pressure of 16 bar. As temperature increases, nominal operating pressure decreases as shown in the following graphs.

PRESSURE CURVE IN RELATION TO TEMPERATURE WITH ALUMINIUM QUICK PIPE AND PA FITTINGS

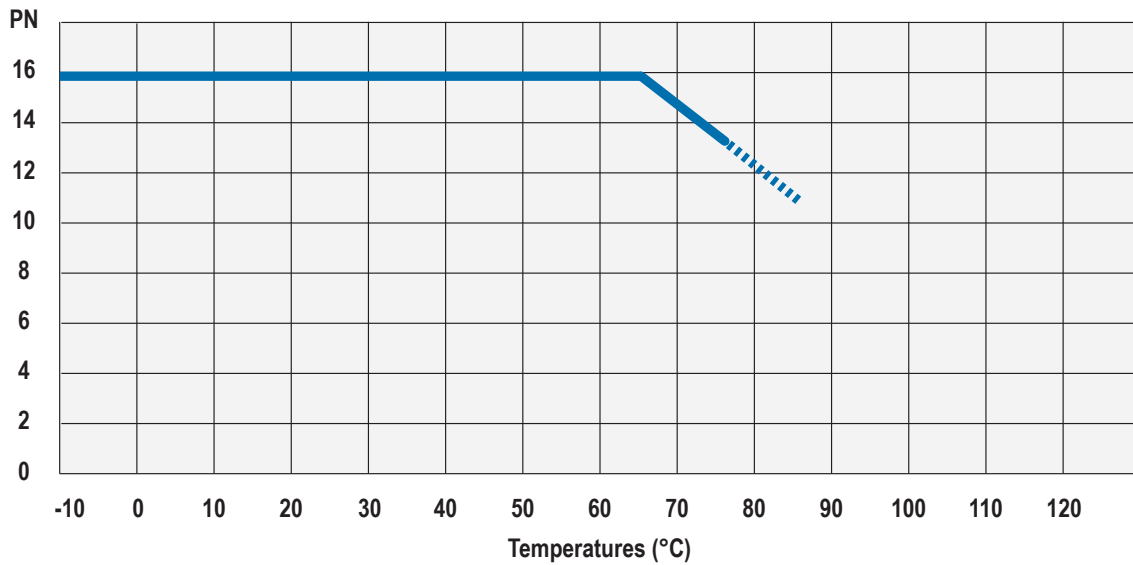

PRESSURE CURVE IN RELATION TO TEMPERATURE WITH ALUMINIUM QUICK PIPE AND ALUMINIUM FITTINGS

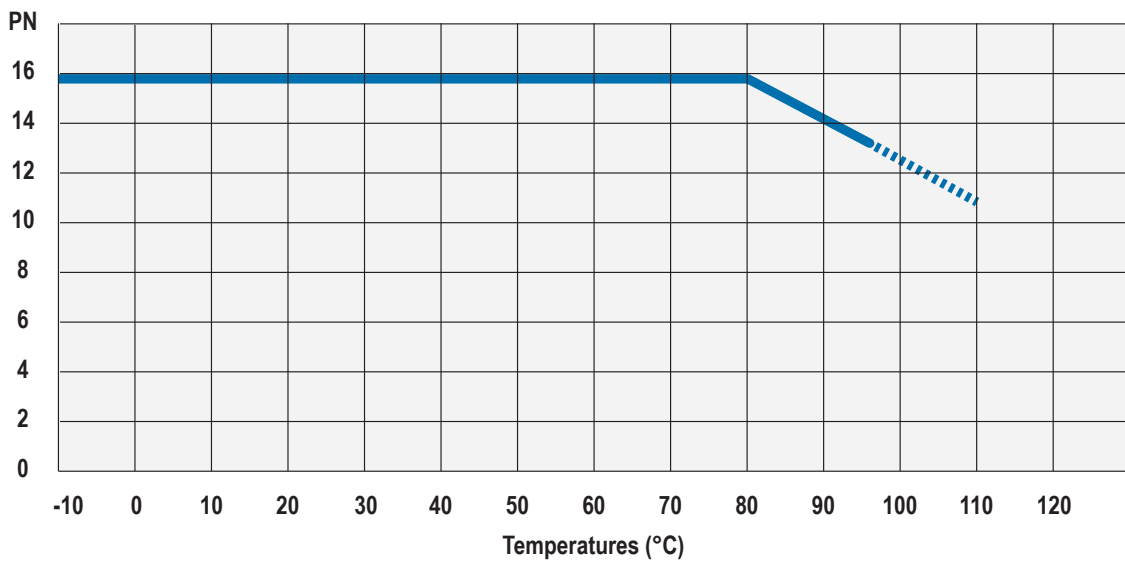

SAFETY INSTRUCTIONS



The AIRCOM system was designed to carry pressurised fluids.

Installers must follow safety procedures and comply with all requirements and local standards related to safety at work.

Installation, operating, maintenance work and repairs must be carried out by authorised, specially trained personnel as stipulated by standards and legislation.

Before carrying out any maintenance or repair work, making adjustments or non-routine controls, de-pressurise the system and cut it completely off from all sources of pressure. Never use components that have not been approved by the manufacturer.

AIRCOM pipes and fittings are not suitable for tracked installation (wall tracking) or for underfloor use.

- Do NOT use the AIRCOM system as a support for electrical appliances or as an earthing system for other appliances or items of machinery.
- Use appropriate tools.
- Use only original spare parts.
- Technopolymer joints are sensitive to direct UV rays; if such joints are exposed, apply suitable protection.
AIRCOM aluminium pipes however have excellent resistance to UV light and no precautionary measures are required.
- Never weld or bend AIRCOM pipes .
- AIRCOM pipes must be suitably protected against violent impacts.
- Before installing pipes, remove all stoppers and/or caps.
- Do NOT use solvents or chemical substances which might damage the materials from which the pipe is made.

Before installation, check the surfaces of the AIRCOM pipes (they should not have any scratches, abrasions, stains etc...).

Never connect AIRCOM pipes directly to a source of vibration; if necessary, use hoses. Before starting up the plant system, the engineer must check that it conforms with all the tests, checks and applicable standards regarding compressed air installations.

At the first start-up, bring the system to a test pressure of 1.5 bar to check for leaks or defective joints. Once the control has been carried out, gradually increase the pressure at a constant rate (max. 1 bar every 30 seconds).

The pipework must be earthed. Where polymer joints are to be used, use suitably sized copper braid to unite the banks of pipes and use two clamps to hold each bank.

AIRCOM 10-YEAR GUARANTEE

As might be expected from such a high quality product range, AIRCOM provides a 10-year guarantee against defective aluminium materials and AIRCOM joints.

Terms of cover of the guarantee:

- The use original spare parts only.
- That installation is carried out following the instructions and guide lines shown in this catalogue.
- The presence of a certificate confirming that the system has been tested.
- That components that have not been approved by the manufacturer have never been used.
- That the system is protected against impacts, vibrations and corrosive environments.
- Before making a claim, check the damaged parts and/or site conditions.
- The AIRCOM guarantee only covers the replacement of components.
- All claims must be sent to the Aircom premises at Novi Ligure (AI) and will be dealt with via standard procedures.



OUR SERVICES: project assistant, commercial service, support

AIRCOM services support our Partners throughout the plant's entire life cycle: from the initial consultancy to support during design.

Project Assistant



AIRCOM technical-commercial teams are at your disposal to study and help design your air network. Our team assist you in your project with:

- Information on the AIRCOM products and services.
 - Training on how to assemble the system
 - Advice on “best practice” in order to reduce your consumption of energy.
 - Ongoing assistance and follow-up.
 - On-site advisory presence at construction and installation locations.
-

Commercial Services



AIRCOM's **CUSTOMER SERVICE** teams will co-ordinate a quick response to your requirements for all information you need.

- Product availability
 - Order processing and follow-up
 - Delivery time-phasing and modification
 - Technical information
 - Design software
-

Contact Support



Wherever you are in the world, you can contact AIRCOM:

- by phone
- by fax
- by e-mail

should you need more information, please refer directly to your contact person in AIRCOM sales organization that you can find on AIRCOM website.

OUR SERVICE: technical training, advanced software, CAD 3D drawings

AIRCOM offers advanced training and periodic update courses for its Partners' technical personnel (designers, installers, dealers).

AIRCOM offices support Aircom Partners at every step, from the more basic plants to the highly complex systems, assisting in totally new designs as well as in revamping and additions to existing structures.

For designers and engineering depts. the complete specification of the whole Quick Line System is available on demand. If needed please refer to your sales contact.

Technical Training & Support to Designers



AIRCOM developed proprietary software to provide support in plant sizing and on site design. Thanks to this software, Aircom Partners can offer the end user a complete, efficient and personalized service.

AIRCOM Software:

- **3D drawing system:** to draw a piping plant with our components on autocad
 - **Quotation:** quote and materials lists on Windows (excel based)
 - **Airtool:** plant sizing starting from end-user actual air demand
 - **Flow rate calculator:** mains piping diameter sizing
-

Advanced Software



All AIRCOM CAD drawings are available in formats DWG and STP.
(DXF also available on demand)

Technical specifications for the AIRCOM system are available in PDF.

Technical Data Sheets are available on demand.
(pls. contact AIRCOM pertaining sales contact).

R&D and Technical Depts. provide for periodic revision of AIRCOM's technical documentation.

CAD & 3D Drawings & Technical Data Sheets



ENERGY SAVING



Over the course of the past ten years "energy management" has played an increasingly important role in the industrial sector.

This expression refers to a whole range of mechanisms and economic, management, strategic and bureaucratic factors which are now required from an industry that is heavily involved in the production of energy.

On the one hand, the price of fossil fuels is constantly increasing and weigh heavily on the costs of running a company. On the other hand, recent legislation regarding environmental protection set limits (but the tendency is towards a reduction) on pollution from power stations.

In this context, companies can find themselves in the position where they need to increase production while cutting energy costs and complying with standards.

Aircom has recently implemented a project intended to make significant energy savings by ensuring plant size calculations are correct and by the intelligent use of materials in plant systems designed for conveying compressed air. This applies to both new and existing plants and involves a detailed examination of production cycles and the use of energy.

Aircom are pleased to help designers, users and maintenance engineers by making available design, monitoring and control tools that can very quickly and accurately determine true energy requirements (kwh) in relation to the amount of compressed air needed by a user (m³/h) with a variation of plant components, or, with the same system test the efficiency of an existing plant.

The results of research have also shown that better geometrical shapes can be created, that the use of different materials for both individual and more complex components can significantly reduce running costs.

Even at a first glance, the energy savings appear to be not just beneficial but so great as to offset the cost of investing in plant equipment in just a few years.

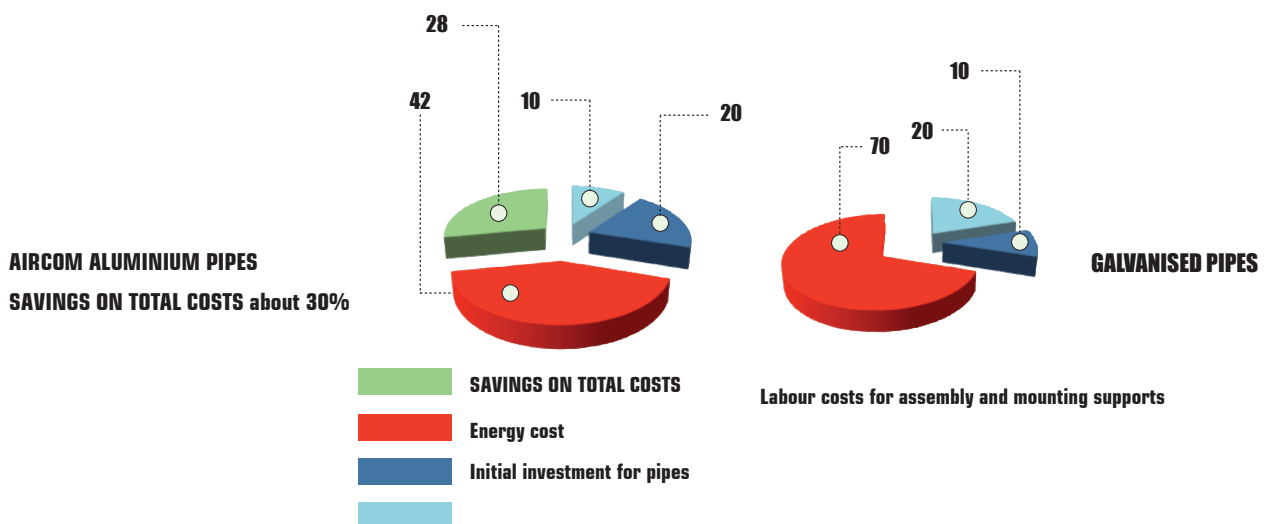

ANALYSIS OF ENERGY SAVINGS ON THE DISTRIBUTION OF COMPRESSED AIR

Plant systems of this kind are found in a very wide range of industries (in heavy and light engineering, farming etc.) where compressed air is used to operate items of equipment, machinery, tools and accessories.

An excellent distribution of pneumatic energy can be compared with network with characteristics that are similar to a cable carrying electrical energy therefore with as few leaks as possible and able to maintain:

- **pressure (minimum pressure drops caused by tightening in the pipe network)**
- **the quantity of air (absence of leaks)**
- **the quality of the air (absence of rust, dust, water, oil etc.).**

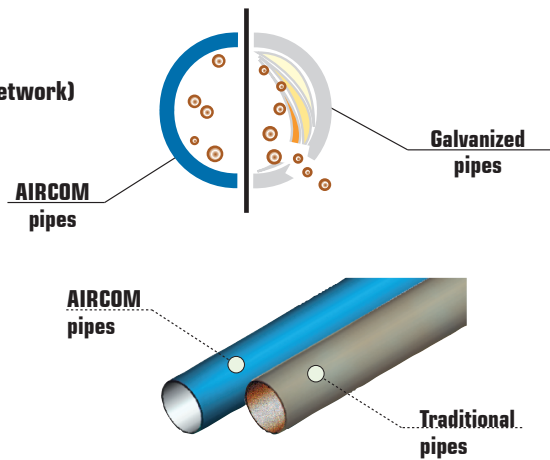

The factors which influence the overall performance of the system (from generation to end use) are mainly of 2 types: pressure drops and losses of mass (concentrated and distributed) and most attention is focussed on these.

Pressure drops are mainly caused by poor lay-outs and incorrect sizing of the distribution network in relation to variations in requirements and the generation of pneumatic energy.

Differentiated pressure levels and air treatment on the other hand play an equally important role in delivering a set quantity of compressed air.

Losses due to leaks should be identified and recorded.

An analysis of the amount of pneumatic energy produced, and of the amount needed to fulfil requirements and measurements of pressure variations in the network, allow its sizing to be evaluated, areas of waste to be identified and reconditioning work to be planned.

80% of existing distribution networks lose pneumatic energy with many waste levels of up to 50%.

COMPRESSED AIR DISTRIBUTION COSTS

in a traditional plant system

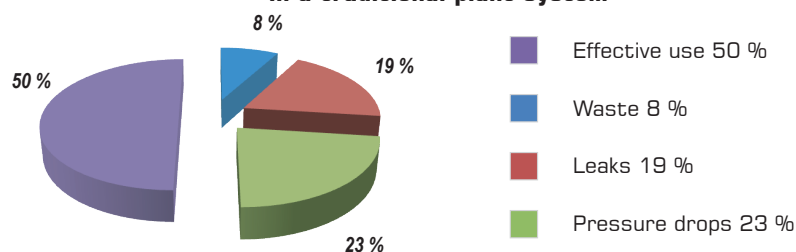

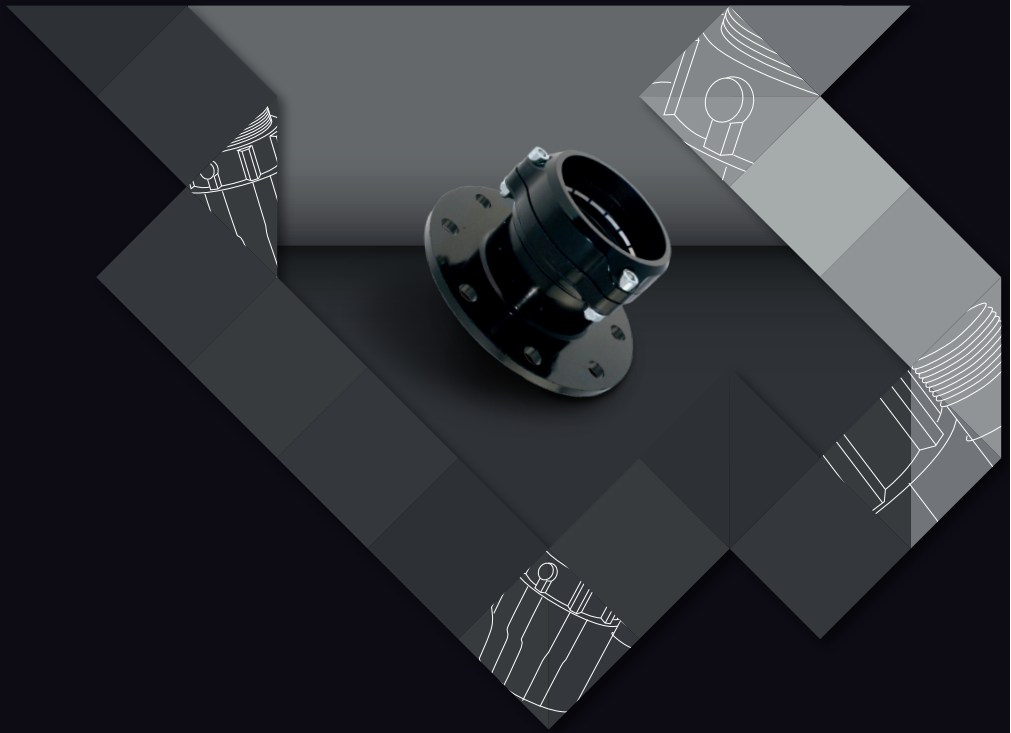

QUICK EASY RELIABLE

ANNEX B

QUICK LINE SYSTEM TECHNICAL DATA SHEETS



C028 - 2022

Aluminium Pipes diam 16 ÷ 220 mm

QLTUAL		Blue Aluminium pipe		
Code	Gr/m	D	bar length	sp
QLTUAL4016S	180	16	4	1
QLTUAL4020S	201	20	4	1,3
QLTUAL020S	201	20	5,8	1,3
QLTUAL4025S	273	25	4	1,4
QLTUAL025S	273	25	5,8	1,4
QLTUAL4032S	402	32	4	1,5
QLTUAL032S	402	32	5,8	1,5
QLTUAL4040S	586	40	4	1,8
QLTUAL040S	586	40	5,8	1,8
QLTUAL4050S	819	50	4	2
QLTUAL050S	819	50	5,8	2
QLTUAL4063S	1039	63	4	2
QLTUAL063S	1039	63	5,8	2
QLTUAL080S	1582	80	5,8	2,4
QLTUAL110S	2367	110	5,8	2,6
QLTUAL168S	5000	168,3	5,8	3,5
QLTUAL220S	6100	220	5,8	4

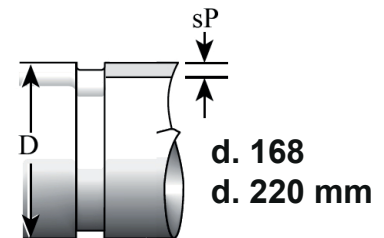
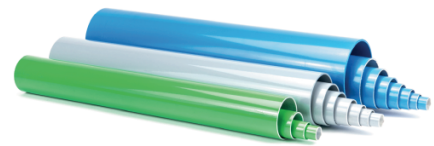
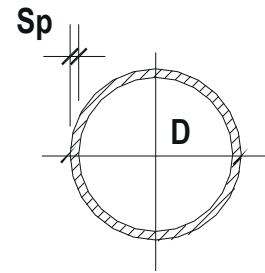

QLTUALGY		Grey aluminium pipe		
Code	Gr/m	D	bar length	sp
QLTUALGY020S	201	20	5,8	1,3
QLTUALGY025S	273	25	5,8	1,4
QLTUALGY032S	402	32	5,8	1,5
QLTUALGY040S	586	40	5,8	1,8
QLTUALGY050S	819	50	5,8	2
QLTUALGY063S	1039	63	5,8	2
QLTUALGY080S	1582	80	5,8	2,4

QLTUALG		Green Aluminium pipe		
Code	Gr/m	D	bar length	sp
QLTUALG020S	201	20	5,8	1,5
QLTUALG025S	273	25	5,8	1,5
QLTUALG040S	586	40	5,8	2
QLTUALG063S	1039	63	5,8	2

QLSCI		Double Bend (Aluminium), Blue		
Code	Gr	D	L	l
QLSCI016	70	16	400	120
QLSCI020	100	20	430	150
QLSCI025	130	25	460	180

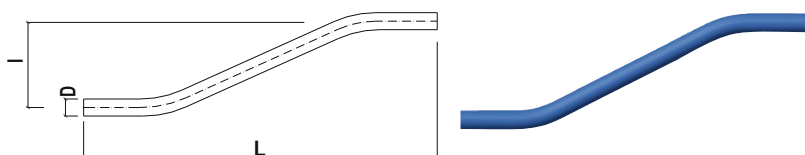

Quick Line Fittings diam 20 ÷ 80 mm

ALUMINIUM



See video
20 ÷ 80 mm

QLMAAL		Coupling			
Code	Gr.	D	L	E	C
QLMAAL020	64	20	77	38	37
QLMAAL025	100	25	95	45	45
QLMAAL032	233	32	120	56	56
QLMAAL040	283	40	156	62	77
QLMAAL050	590	50	165	81	75
QLMAAL063	966	63	193	97	95
QLMAAL080	1492	80	232	116	114

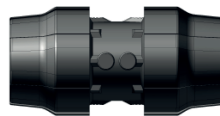
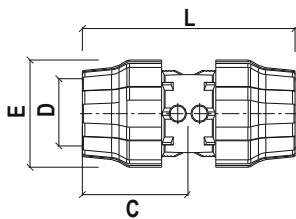

QLMASAL		Sliding Coupling			
Code	Gr.	D	L	E	C
QLMASAL032	230	32	120	56	56
QLMASAL040	280	40	156	62	77
QLMASAL050	586	50	165	81	75
QLMASAL063	962	63	193	97	95
QLMASAL080	1489	80	232	116	114

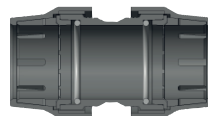
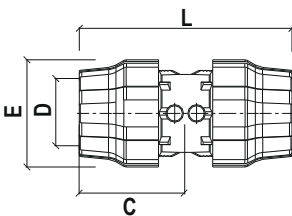

QLGO90AL		90° Elbow			
Code	Gr.	D	L	E	C
QLGO90AL020	78	20	72	38	37
QLGO90AL025	134	25	98	45	45
QLGO90AL032	275	32	120	56	56
QLGO90AL040	326	40	130	62	77
QLGO90AL050	748	50	145	81	75
QLGO90AL063	1033	63	180	97	95
QLGO90AL080	1770	80	217	116	114

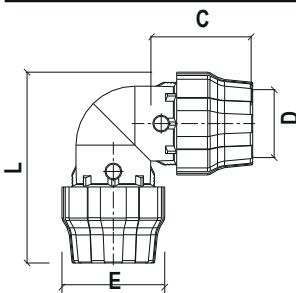

Legend

α	Angular
C	Socket depth
C1	Socket depth 1
D	Socket diameter
D1	Socket diameter 1
Dp	Hollow mill driving diameter
Dpt	Largeness
d	Thread diameter
d1	Thread diameter 1
d2	Thread diameter 2
d3	Thread diameter 3
E	Overall outside diameter ring nut
E1	Overall outside diameter ring nut 1
Gr	Weight in grams
H	Height
On	holes number
L	Length
L1	Length 1
L2	Length 2
L Axial	Axial Length / Wheelbase
I	Misalignment
I1	Misalignment 1
r	Curvature radius (max)

Quick Line Fittings diam 20 ÷ 80 mm

QLGO45AL		45° Elbow				
Code	Gr.	D	L	E	C	
QLGO45AL020	73	20	82	38	37	
QLGO45AL025	123	25	101	45	45	
QLGO45AL032	252	32	130	56	56	
QLGO45AL040	303	40	160	62	77	

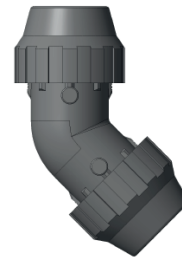
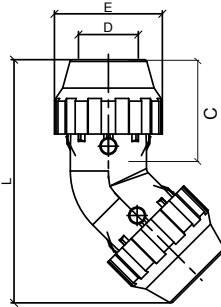

QLGO90MAL		90° Elbows, male thread				
Code	Gr.	D	d	L	E	C
QLGO90MAL020048	50	20	1/2"	65	38	37
QLGO90MAL025048	80	25	1/2"	80	45	45
QLMASAL025068	80	25	3/4"	80	45	45

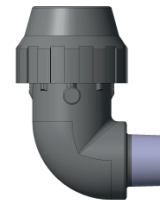
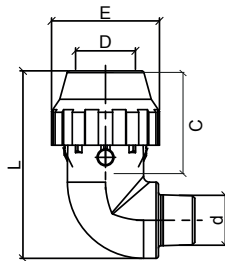

QLGO45FAL		45° Elbows, female thread				
Code	Gr.	D	d	L	E	C
QLGO45FAL020048	54	20	1/2"	65	38	37
QLGO45FAL025048	94	25	1/2"	80	45	45
QLGO45FAL025068	94	25	3/4"	80	45	45

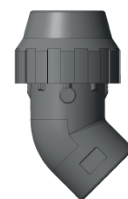
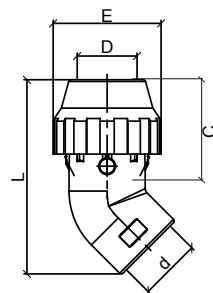

Quick Line Fittings diam 20 ÷ 80 mm

QLCAAL	End Cap				
Code	Gr.	D	L	E	C
QLCAAL020	122	20	38	38	37
QLCAAL025	142	25	45	45	45
QLCAAL032	320	32	56	56	56
QLCAAL040	425	40	94	62	77
QLCAAL050	977	50	106	81	75
QLCAAL063	1168	63	139	97	95
QLCAAL080	1609	80	163	116	114

ALUMINIUM

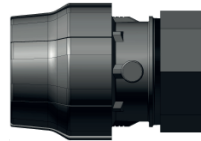
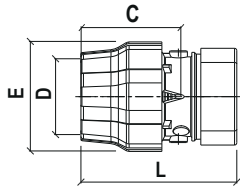

QLTEAL	90° Tee					
Code	Gr.	D	L	E	H	C
QLTEAL020	115	20	100	38	72	37
QLTEAL025	195	25	125	45	98	45
QLTEAL032	400	32	130	56	120	56
QLTEAL040	499	40	132	62	132	77
QLTEAL050	1075	50	150	84	145	75
QLTEAL063	1453	63	263	97	181	95
QLTEAL080	2534	80	318	116	217	114



See video
20 ÷ 80 mm

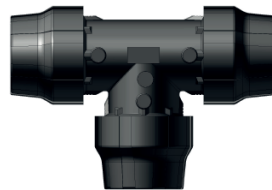
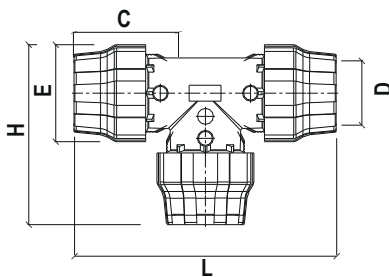

QLTPAL	Threaded Tee, female thread						
Code	Gr.	D	d	L	E	H	C
QLTPAL020048	89	20	1/2"	100	38	46	37
QLTPAL025068	160	25	3/4"	125	45	52	45
QLTPAL032088	330	32	1"	130	56	65	56
QLTPAL040108	366	40	1.1/4"	132	62	70	77
QLTPAL050128	863	50	1.1/2"	150	81	100	75
QLTPAL063168	1126	63	2"	263	97	112	95
QLTPAL080208	2120	80	2.1/2"	318	116	136	114

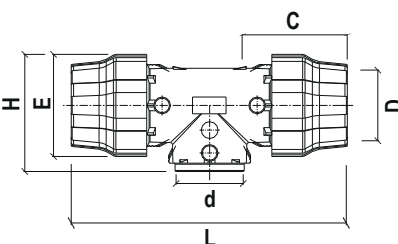

Legend

α	Angular
C	Socket depth
C1	Socket depth 1
D	Socket diameter
D1	Socket diameter 1
Dp	Hollow mill driving diameter
Dpt	Largeness
d	Thread diameter
d1	Thread diameter 1
d2	Thread diameter 2
d3	Thread diameter 3
E	Overall outside diameter ring nut
E1	Overall outside diameter ring nut 1
Gr	Weight in grams
H	Height
On	holes number
L	Length
L1	Length 1
L2	Length 2
L Axial	Axial Length / Wheelbase
l	Misalignment
l1	Misalignment 1
r	Curvature radius (max)

QLTRAL		Reducing Tee					
Code	Gr.	D	L	E	H	C	C1
QLTRAL025020	182	25x20	126,70	45,50	80,50	46	37
QLTRAL032020	330	32x20	160,35	56,00	87	57,50	37
QLTRAL040020	500	40x20	201,45	67,50	98	77	35
QLTRAL040025	517	40x25	202,15	67,50	106,50	77	46
QLTRAL050020	968	50x20	215,85	81,30	127	74	44
QLTRAL050025	975	50x25	216,50	81,30	135	74	53
QLTRAL063020	1330	63x20	248,75	97,50	145	86,50	43
QLTRAL063025	1350	63x25	248,90	97,50	154	86,50	53

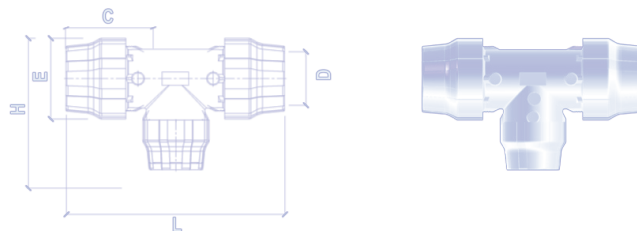

QLMPMAL		Nipple Socket - Aluminium body - HR-P composite nut				
Code	Gr.	D	d	L	E	C
QLMPMAL020048	100	20	1/2"	67	45,40	47,50
QLMPMAL020068	103	20	3/4"	68	45,40	47,50
QLMPMAL025088	140	25	1"	77,50	52,20	53,50
QLMPMAL032108	225	32	1.1/4"	90	52,80	63
QLMPMAL040128	435	40	1.1/2"	106	77,30	77,50
QLMPMAL050168	586	50	2"	117	88,40	85

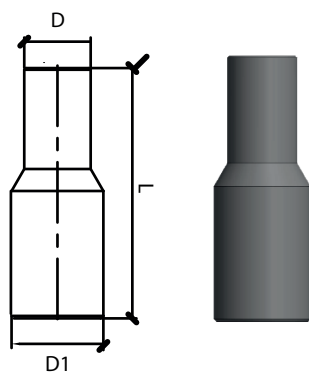
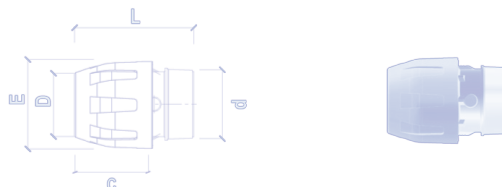

QLRIDTU		Reduction pipe, male/male connection			
Code	Gr.	D	D1	L	
QLRIDTU020016	0,0320	20	16	117,6	
QLRIDTU025016	0,0524	25	16	121,6	
QLRIDTU025020	0,0609	25	20	133,25	
QLRIDTU032020	0,0716	32	20	120	
QLRIDTU032025	0,0802	32	25	126,3	
QLRIDTU040025	0,168	40	25	156	
QLRIDTU040032	0,262	40	32	164,35	
QLRIDTU050032	0,393	50	32	170,7	
QLRIDTU050040	0,273	50	40	190,75	
QLRIDTU063040	0,730	63	40	224,20	
QLRIDTU063050	0,656	63	50	213,1	
QLRIDTU080050	1,317	80	50	248,6	
QLRIDTU080063	1,212	80	63	263,5	

Quick Line Fittings diam 20 ÷ 80 mm

QLMMMAL						
Nipple Socket - Aluminium body - male threaded						
Code	Gr.	D	d	L	E	C
QLMMMAL020048	43	20	1/2"	53	38	37
QLMMMAL020068	45	20	3/4"	53	38	37
QLMMMAL025068	63	25	3/4"	58	45	45
QLMMMAL025088	68	25	1"	58	45	45
QLMMMAL032108	150	32	1.1/4"	81	56	56
QLMMMAL040128	322	40	1.1/2"	94	62	77
QLMMMAL050168	457	50	2"	106	81	75
QLMMMAL063168	518	63	2"	130	97	95
QLMMMAL063208	545	63	2.1/2"	130	97	95
QLMMMAL080208	907	80	2.1/2"	152	116	114
QLMMMAL080248	1027	80	3"	155	116	114

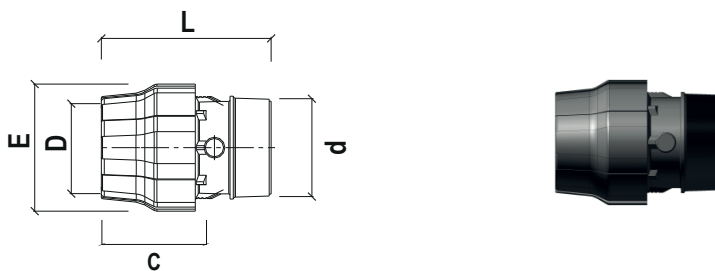

QLMPMAL						
Nipple Socket - Aluminium body - female threaded						
Code	Gr.	D	d	L	E	C
QLMPMAL020048	44	20	1/2"	55	38	37
QLMPMAL020068	45	20	3/4"	55	38	37
QLMPMAL025068	68	25	3/4"	60	45	45
QLMPMAL025088	70	25	1"	60	45	45
QLMPMAL032108	157	32	1.1/4"	81	56	56
QLMPMAL040128	335	40	1.1/2"	94	62	77
QLMPMAL050168	468	50	2"	106	81	75
QLMPMAL063208	582	63	2.1/2"	134	97	95

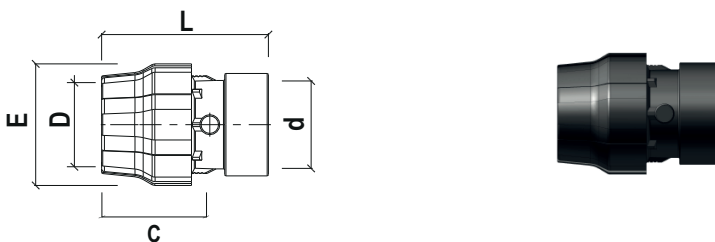

Legend

α	Angular
C	Socket depth
C1	Socket depth 1
D	Socket diameter
D1	Socket diameter 1
Dp	Hollow mill driving diameter
Dpt	Largeness
d	Thread diameter
d1	Thread diameter 1
d2	Thread diameter 2
d3	Thread diameter 3
E	Overall outside diameter ring nut
E1	Overall outside diameter ring nut 1
Gr	Weight in grams
H	Height
On	holes number
L	Length
L1	Length 1
L2	Length 2
L Axial	Axial Length / Wheelbase
l	Misalignment
l1	Misalignment 1
r	Curvature radius (max)

Quick Line Fittings diam 110 mm

ALUMINUM



See video
110 mm

QLMAAL		Coupling diam 110 mm				
Code	Gr.	D	L	H	C	
QLMAAL110	1762	110	211	153	102	

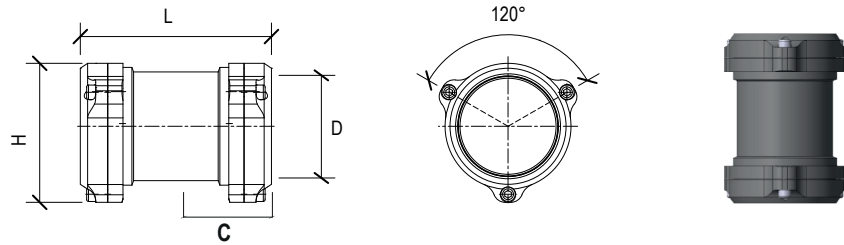

QLGO90AL		90° Elbow diam 110 mm				
Code	Gr.	D	L	H	C	
QLGO90AL110	2190	110	251	162	102	

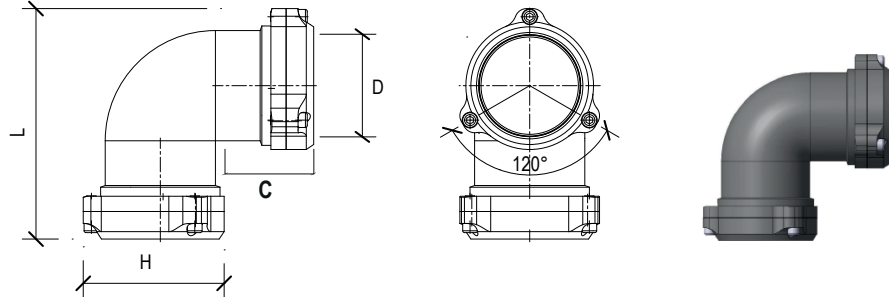

QLTEAL		90° Tee diam 110 mm				
Code	Gr.	D	L	H	C	
QLTEAL110	4080	110	335	227	102	

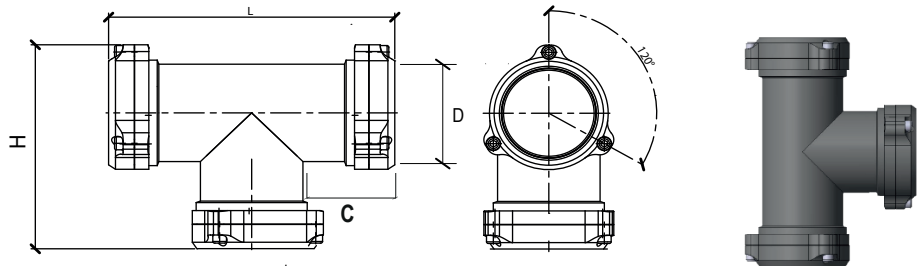

QLTPAL		90° threaded Tee diam 110 mm				
Code	Gr.	D	d	L	H	C
QLTPAL110248	3400	110	3"	335	221	102

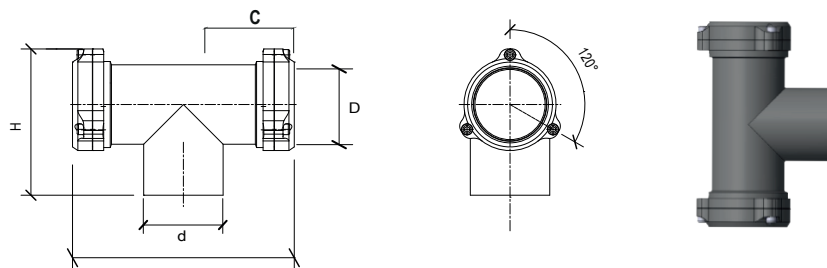

Quick Line Fittings diam 63 ÷ 110 mm

* Flange DN 50 threaded G 2"
 ** Flange DN 80 threaded G 3"
 *** Flange DN 100 threaded G 4"

QLMFLAL		Flanged Coupling					
Code	Gr.	D	E	L	H	L Axial	C
QLMFLAL063168 *	1269	63	97	165	125	125	95
QLMFLAL080248 **	1783	80	116	200	135	160	114

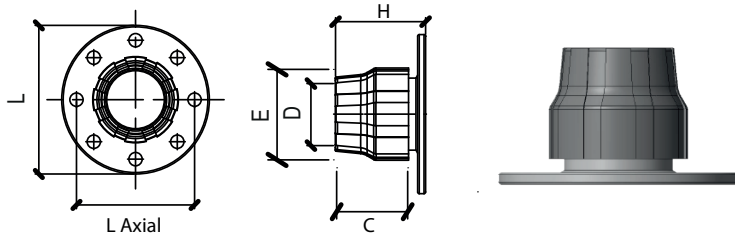

QLMFLAL		Flanged Coupling					
Code	Gr.	D	E	L	H	L Axial	C
QLMFLAL110328	2400	110	153	220	123	180	106

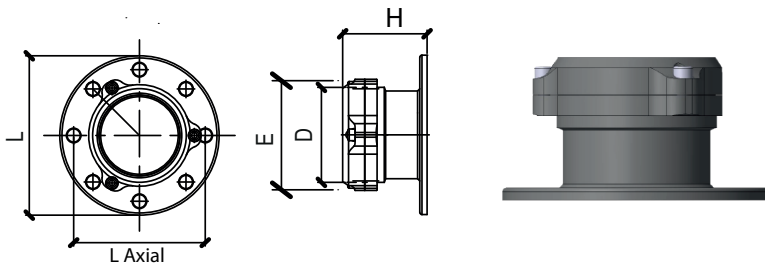

QLTFLAL		Flanged Tip				
Code	Gr.	D	L	H	L Axial	C
QLTFLAL80208 **	1823	80	227	172	160	114
QLTFLAL110248 ***	2610	110	227	180	180	106

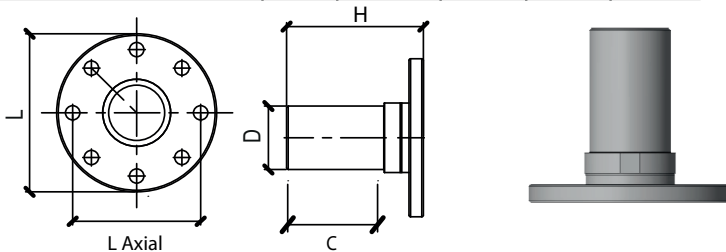

QLRIDTU		Reduction pipe, male/male connection			
Code	Gr.	D	D1	L	
QLRIDTU110050	2432,5	110	50	261	
QLRIDTU110063	2186,1	110	63	276	
QLRIDTU110080	2160,9	110	80	282	



Legend

α	Angular
C	Socket depth
C1	Socket depth 1
D	Socket diameter
D1	Socket diameter 1
Dp	Hollow mill driving diameter
Dpt	Largeness
d	Thread diameter
d1	Thread diameter 1
d2	Thread diameter 2
d3	Thread diameter 3
E	Overall outside diameter ring nut
E1	Overall outside diameter ring nut 1
Gr	Weight in grams
H	Height
On	holes number
L	Length
L1	Length 1
L2	Length 2
L Axial	Axial Length / Wheelbase
l	Misalignment
l1	Misalignment 1
r	Curvature radius (max)

Quick Line Fittings D. 168,3 mm/220 mm - 6"/8"

QLMAAL	Straight Coupling, Rigid				
Code	Gr.	D	L	H	Dpt
QLMAAL168	3700	168,3	286	57	207
QLMAAL220	6800	220	362	67	267

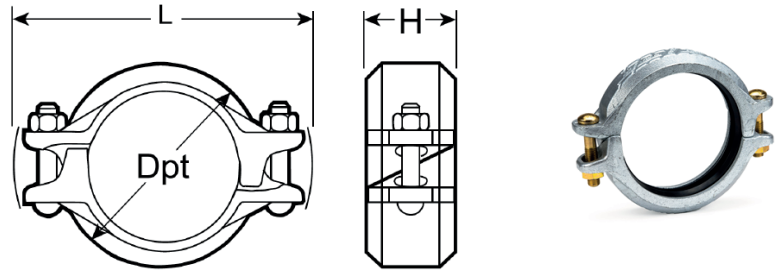

QLGO90AL	90° Elbow grooved ends				
Code	Gr.	D	L	H	C
QLGO90AL168	2900	168,3	250	250	30,96
QLGO90AL220	6400	220	306,55	306,55	30,96

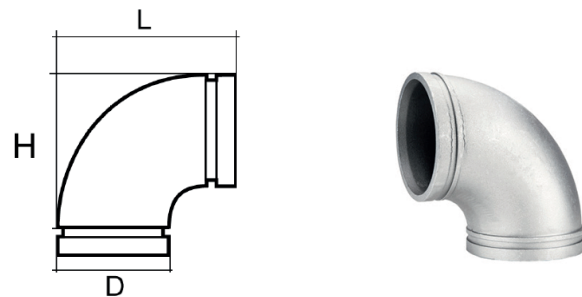

QLTEAL	Equal Tee grooved ends				
Code	Gr.	D	L	H	C
QLTEAL168	4100	168,3	330	250	25
QLTEAL220	8300	220	394	306,555	30,96

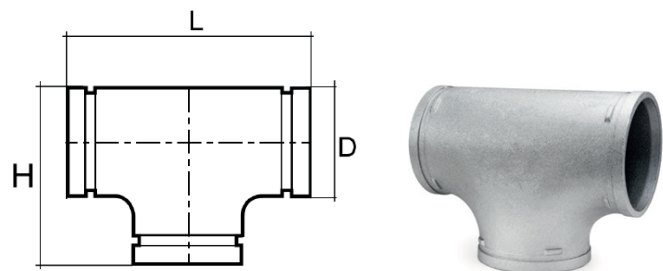

Quick Line Fittings D. 168,3 mm/220 mm - 6"/8"

QLGO45AL 45° Elbow 168,3 mm Aluminum grooved ends					
Code	Gr.	D	H	α	C
QLGO45AL168	2400	168,3	178	45°	25
QLGO45AL220	3700	220	216	45°	30,96

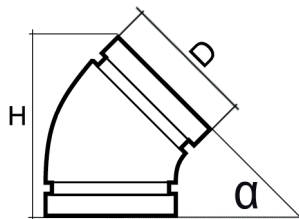

QLFLA Flanged adapter						
Code	Gr.	D	L	H	L Axial	Dpt
QLFLA168480DIN	4500	168,3	302	25	241	279
QLFLA220640DIN	7500	220	368,3	29,3	295,3	343,3

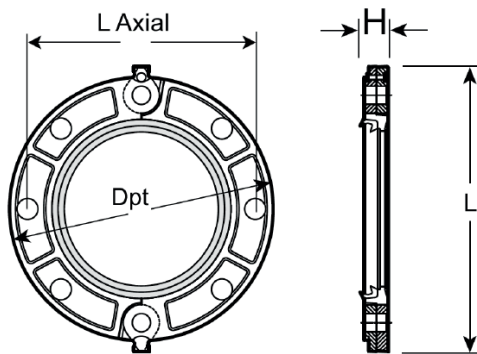

Legend

α	Angular
C	Socket depth
C1	Socket depth 1
D	Socket diameter
D1	Socket diameter 1
Dp	Hollow mill driving diameter
Dpt	Largeness
d	Thread diameter
d1	Thread diameter 1
d2	Thread diameter 2
d3	Thread diameter 3
E	Overall outside diameter ring nut
E1	Overall outside diameter ring nut 1
Gr	Weight in grams
H	Height
On	holes number
L	Length
L1	Length 1
L2	Length 2
L Axial	Axial Length / Wheelbase
l	Misalignment
l1	Misalignment 1
r	Curvature radius (max)

Quick Line Fittings D. 168 mm/220 mm - 6"/8"

QLDER		Quick branch plug female thread			
Code	Gr.	D	d	L	H
QLDER168108	2300	168,3	1.1/4"	232	83
QLDER168128	2400	168,3	1.1/2"	232	83
QLDER168168	2700	168,3	2"	232	99
QLDER168208	3800	168,3	2.1/2"	267	118
QLDER168248	4500	168,3	3"	267	135
QLDER220168	5300	220	2"	316	114

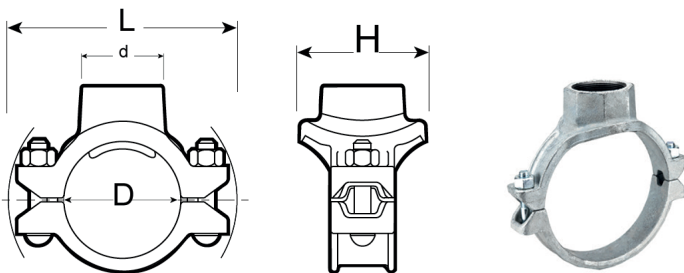

QLCAAL		End cap 168,3 mm Aluminium grooved end		
Code	Gr.	D	L	H
QLCAAL168	1400	168,3	168,3	25
QLCAAL220	2700	220	220	32

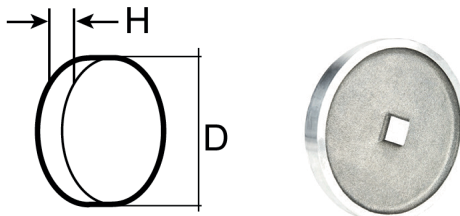

QLRIDTU		Reduction 168,3 mm grooved male/male connection			
Code	Gr.	D	D1	L	
QLRIDTU168063	1835,6	168,3	63	324,45	
QLRIDTU168080	3363,3	168,3	80	334,6	
QLRIDTU168110	3279	168,3	110	293,40	
QLRIDTU220080	3393	220	80	368	
QLRIDTU220110	3695	220	110	363,45	
QLRIDTU220168	2118,8	220	168,3	126	



Wall Mount Manifolds

DIRAPMAL		Single port manifold, female threads				
Code	Gr.	D	d	H	L	L Axial
DIRAPMAL048048	148	1/2"	1/2"	78	34	35

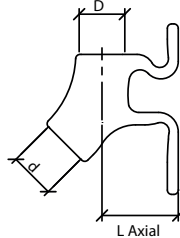
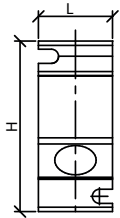

DIRAPFRLAL		Three port manifold, female threads + drain 1/4" blind						
Code	Gr.	D	d	d1	d2	H	L	L axial
DIRAPFRLAL048048	360	1/2"	1/2"	1/4"	1/2"	88	55	35

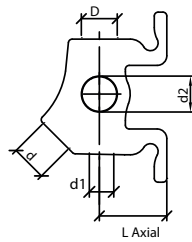
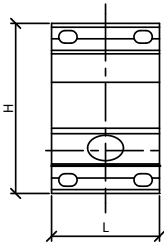

DIRAPLAL		Four port manifold, female threads + drain 1/4" blind						
Code	Gr.	D	d	d1	d2	H	L	L Axial
DIRAPLAL048048	450	1/2"	1/2"	1/4"	1/2"	88	88	35
DIRAPLAL068068	465	3/4"	1/2"	1/4"	3/4"	88	88	35

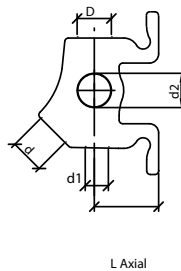
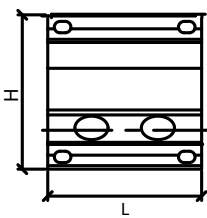

DIRPMUAL120		Five port manifold, female threads + drain 1/4" blind						
Code	Gr.	D	d	d1	d2	H	L	L Axial
DIRPMUAL120	687	3/4"	1/2"	1/4"	3/4"	88	125	35

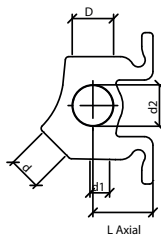
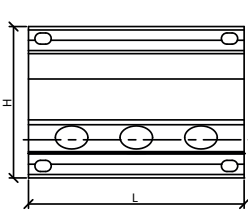

N.B. d1 = drain 1/4" (blind)

Legend

α	Angular
C	Socket depth
C1	Socket depth 1
D	Socket diameter
D1	Socket diameter 1
Dp	Hollow mill driving diameter
Dpt	Largeness
d	Thread diameter
d1	Thread diameter 1
d2	Thread diameter 2
d3	Thread diameter 3
E	Overall outside diameter ring nut
E1	Overall outside diameter ring nut 1
Gr	Weight in grams
H	Height
On	holes number
L	Length
L1	Length 1
L2	Length 2
L Axial	Axial Length / Wheelbase
l	Misalignment
l1	Misalignment 1
r	Curvature radius (max)

CERTIFICATIONS AND TREATMENTS - GUARANTEED FOR 10 YEARS



A TÜV certified product guarantees safety and quality. The TÜV Group issues a certificate with the results of tests carried out. This certifies the properties of products and shows the standards that apply to the tests performed.



RINA

A RINA certified product means it has high resistance to external factors. In the case of the Quick Line series, we subjected our Quick Line series products to RINA testing and also obtained certifications for fire resistance.

For further information, contact our Technical Department for the certifications dossier.



AIRCOM products have obtained special T.S.S.A. certification

(Technical Standards & Safety Authority) which sets the different standards specifically required in North America.



AIRCOM products benefit from use of the QUALICOAT brand name which certifies the quality of the paint used to provide excellent characteristics that add to the superior performance properties of our products even under particularly severe environmental operating conditions.



A QUALANOD certified product means safety as regards the process treatments it receives. In effect, the certification relates to the anodising process.

Our products have long life spans thanks to having better resistance to corrosion than our competitors' products.



The ALODINE 400 process provides pipes with an inner and outer coating. This is a titanium, chrome-free process which complies with the ROHS Directive.

Apart from protecting against oxidising, this coating provides better performance characteristics in terms of smoother surfaces inside the pipe meaning a better compressed air flow rates .

DECLARATION OF CONFORMITY AND STANDARDS

The pressurised components (AIRCOM pipes and fittings) were designed to conform with appendix VII of European Directive 97/23/CE) only as regards Article 3.3.



All the pressurised components we manufacture bear our Company name. Conformity assessments and subsequent conformity procedures stipulated by the Directive, have been applied by Aircom to products sold as individual products even if not so required by the Directive (Guide Line 1/9).

Quick Line Valves

QLVAINOX		Quick Line steel ball valve, male threaded				
Code	Gr.	D	E	L	H	C
QLVAINOX025	700	25	45	168	124	45
QLVAINOX032	2040	32	56	265	138	56
QLVAINOX040	1930	40	62	269	138	77
QLVAINOX050	3000	50	81	308	147	75
QLVAINOX063	3260	63	97	376	175	95
QLVAINOX080	8390	80	116	483	200	114

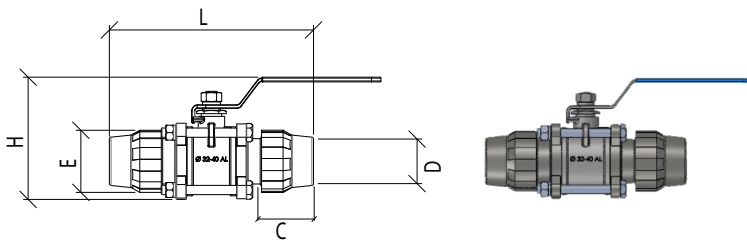

QLVAINOXF		Quick Line steel ball valve, fem. threaded with nipple male					
Code	Gr.	D	d	E	L	H	C
QLVAINOXMF025088	800	25	1/2"	45	168	120	45
QLVAINOXMF032128	2200	32	1.1/2"	56	215	134	56
QLVAINOXMF040128	2050	40	1.1/2"	62	225	134	77
QLVAINOXMF050168	3200	50	2"	81	274	143	75
QLVAINOXMF063168	3500	63	2"	97	309	171	95
QLVAINOXM080248	8600	80	3"	116	393	196	114

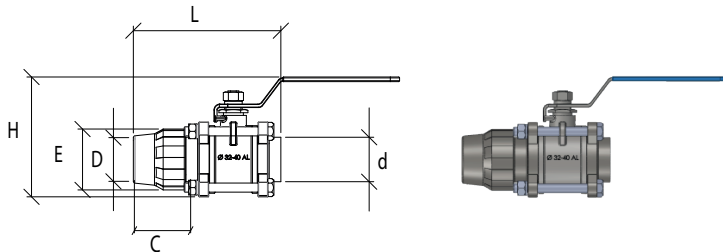

QLVAMAL		Quick Line male threaded connection ball valve					
Code	Gr.	D	d	E	L	H	C
QLVAM016048	278.3	16	1/2"	38	93.60	64,5	37,3
QLVAM020048AL	320	20	1/2"	45	104	60	48
QLVAM025068AL	470	25	3/4"	51	106	60	52

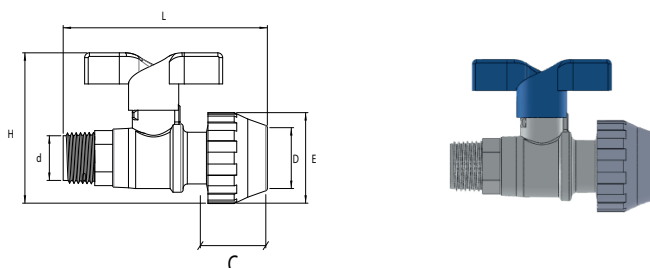

Legend

α	Angular
C	Socket depth
C1	Socket depth 1
D	Socket diameter
D1	Socket diameter 1
Dp	Hollow mill driving diameter
Dpt	Largeness
d	Thread diameter
d1	Thread diameter 1
d2	Thread diameter 2
d3	Thread diameter 3
E	Overall outside diameter ring nut
E1	Overall outside diameter ring nut 1
Gr	Weight in grams
H	Height
On	holes number
L	Length
L1	Length 1
L2	Length 2
L Axial	Axial Length / Wheelbase
l	Misalignment
l1	Misalignment 1
r	Curvature radius (max)



See video
QL Aluminium

Quick Line Valves

QLVALFAR		Butterfly valve, Wafer / LUG, 63 mm-220 mm				
Code	Gr.	D	E	L	H	C
*1 QLVALFAR063	6000	63	97,50	285	290	88
*2 QLVALFAR063L	7000	63	97,50	284	280	88
*1 QLVALFAR080	9000	80	115,70	325	320	117,30
*2 QLVALFAR080L	10000	80	115,70	324	330	117,30
*1 QLVALFAR110	12000	110	152,30	350	355	105
*2 QLVALFAR110L	13000	110	152,30	303	350	105
*1 QLVALFAR168	22000	168,3	285	165	355	25
*2 QLVALFAR168L	26000	168,3	285	163	435	25
*1 QLVALFAR220	36000	220	343,3	183	510	30,96
*2 QLVALFAR220L	37000	220	343,3	190	520	30,96

N.B.

*1 Butterfly valve type WAFER

*2 Butterfly valve type LUG

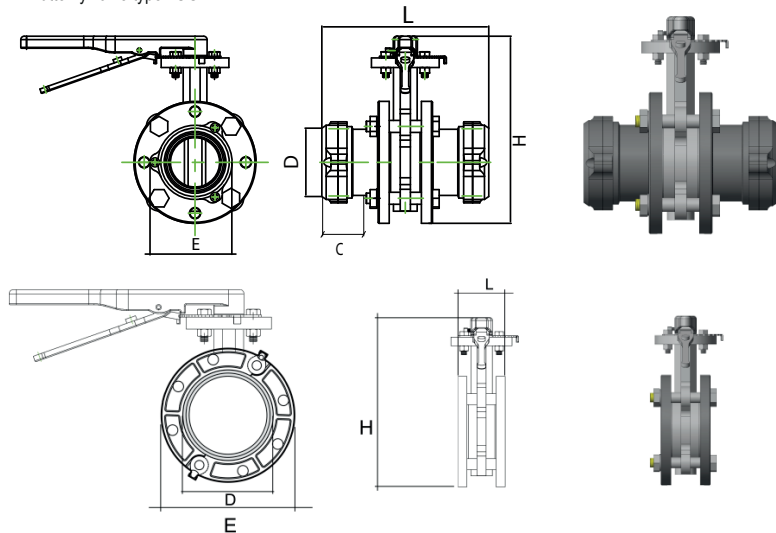

QLVAFAL		Quick Line female threaded connection ball valve					
Code	Gr.	D	d	E	L	H	C
QLVAF016048	278,5	16	1/2"	38	86	64,5	37,3
QLVAF020048AL	320	20	1/2"	45	104	60	48
QLVAF025068AL	470	25	3/4"	51	106	60	52

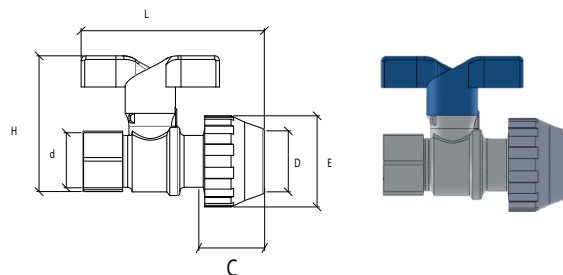

Quick Line Valves

QLVASS	Quick Line steel ball valve, male threaded					
Code	Gr.	D	E	L	H	C
QLVASS020	373	20	38,30	103,50	80	37
QLVASS025	538	25	45,50	127,50	88	46
QLVASS032	838	32	56	156	97	58,50
QLVASS040	1398	40	67,50	205	107	77
QLVASS050	1872	50	81,30	209	128	76
QLVASS063	2849	63	97,50	246	146	88
QLVASS080	4846	80	116	323,30	174	118,50

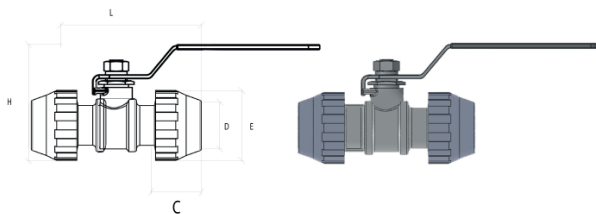

QLVASSM	Quick Line female threaded connection ball valve with aluminium ring nut						
Code	Gr.	D	d	E	L	H	C
QLVASSM020068	365	20	3/4"	38,30	93	80	37
QLVASSM025088	515	25	1"	45,50	113	88	46
QLVASSM032108	774	32	1.1/4"	56	132	97	58,50
QLVASSM040128	1197	40	1.1/2"	67,50	160	107	77
QLVASSM050168	1668	50	2"	81,30	171	128	76
QLVASSM063208	2469	63	2.1/2"	97,50	197	146	88
QLVASSM080248	4124	80	3"	116	250	174	118,50

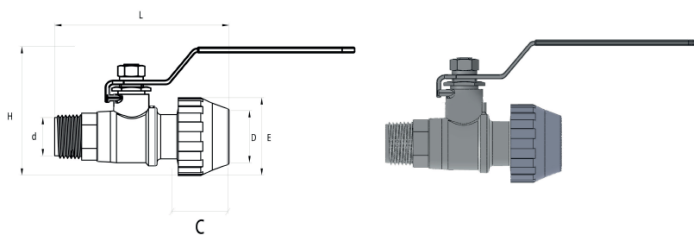

QLVASSF	Quick Line male threaded connection ball valve with aluminium ring nut						
Code	Gr.	D	d	E	L	H	C
QLVASSF020068	342	20	3/4"	38,30	85	80	37
QLVASSF025088	475	25	1"	45,50	105	88	46
QLVASSF032108	724	32	1.1/4"	56	125	97	58,50
QLVASSF040128	1166	40	1.1/2"	67,50	154	107	77
QLVASSF050168	1582	50	2"	81,30	158	128	76
QLVASSF063208	2357	63	2.1/2"	97,50	190	146	88
QLVASSF080248	3968	80	3"	116	243	174	118,50

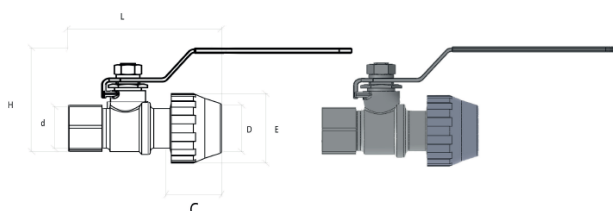

Legend

α	Angular
C	Socket depth
C1	Socket depth 1
D	Socket diameter
D1	Socket diameter 1
Dp	Hollow mill driving diameter
Dpt	Largeness
d	Thread diameter
d1	Thread diameter 1
d2	Thread diameter 2
d3	Thread diameter 3
E	Overall outside diameter ring nut
E1	Overall outside diameter ring nut 1
Gr	Weight in grams
H	Height
On	holes number
L	Length
L1	Length 1
L2	Length 2
L Axial	Axial Length / Wheelbase
l	Misalignment
l1	Misalignment 1
r	Curvature radius (max)

QLDERAL		Quick branch plug with aluminium nut						
Code	Gr.	D	D1	L	E	L1	Dp	L Axial
QLDERAL025020	195	25	20	113	45	52	19	24,5
QLDERAL032020	200	32	20	113	45	52	19	24,5
QLDERAL040020	250	40	20	125	45	52	24	29,6
QLDERAL040025	260	40	25	125	51	52	24	29,6
QLDERAL050020	315	50	20	145	45	60	24	31
QLDERAL050025	323	50	25	145	51	60	24	31
QLDERAL063020	360	63	20	145	45	60	24	43
QLDERAL063025	372	63	25	145	51	60	24	43
QLDERAL063032	420	63	32	145	61	60	24	43
QLDERAL080020	1080	80	20	220	45	63	24	71
QLDERAL080025	1095	80	25	220	51	63	24	71
QLDERAL080032	1140	80	32	220	61	63	24	71
QLDERAL110020	830	110	20	220	45	63	24	71
QLDERAL110025	830	110	25	220	51	63	24	71
QLDERAL110032	850	110	32	220	61	63	24	71

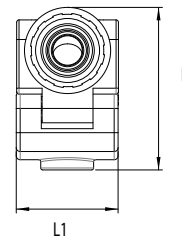
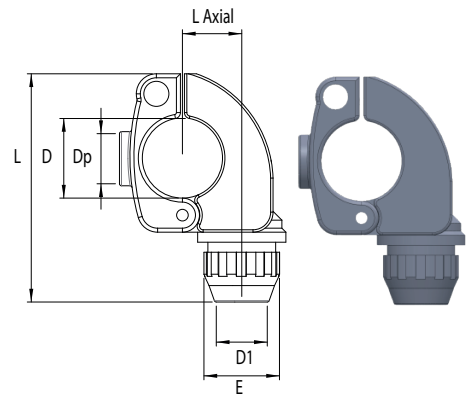

See video
Quick branch plugs

DIRDERFF		Quick branch plug, f thread outlet (aluminium)						
Code	Gr	D	d	L	E	L1	Dp	L Axial
DIRDERFF025048	238	25	1/2"	113	45	52	19	24,5
DIRDERFF032048	217	32	1/2"	113	45	52	19	24,5
DIRDERFF040048	274	40	1/2"	125	45	52	24	29,6
DIRDERFF040068	302	40	3/4"	125	51	52	24	29,6
DIRDERFF050048	402	50	1/2"	145	45	60	24	31
DIRDERFF050068	487	50	3/4"	145	51	60	24	31
DIRDERFF063048	368	63	1/2"	145	45	60	24	43
DIRDERFF063068	396	63	3/4"	145	51	60	24	43
DIRDERFF063088	620	63	1"	148	61	60	24	43
DIRDERFF080048	1191	80	1/2"	220	45	63	24	71
DIRDERFF080068	1153	80	3/4"	220	51	63	24	71
DIRDERFF080088	1160	80	1"	220	61	63	24	71
DIRDERFF110068	900	110	3/4"	220	51	63	24	71
DIRDERFF110088	900	110	1"	220	61	63	24	71

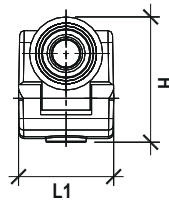
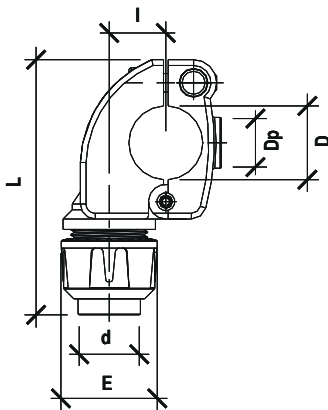

QLPUNM	Male threaded Quick Line Spigot (aluminium)			
Code	Gr.	D	d	L
QLPUNM016038	25	16	3/8"	93
QLPUNM020048	36	20	1/2"	95
QLPUNM020068	52	20	3/4"	96
QLPUNM025088	86	25	1"	108
QLPUNM032108	170	32	1.1/4"	119
QLPUNM040128	224	40	1.1/2"	135
QLPUNM050168	400	50	2"	141
QLPUNM063168	481	63	2"	157
QLPUNM080248	695	80	3"	171

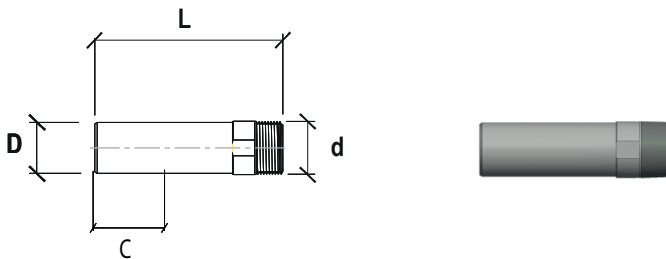

DIRFLFF	Threaded flange					
Code	Gr.	L	d	H	L Axial	On
DIRFLFF168DIN	741	165	2.1/2"	18	125	4
DIRFLFF248DIN	1123	200	3"	20	160	8
DIRFLFF328DIN	1263	220	4"	22	180	8

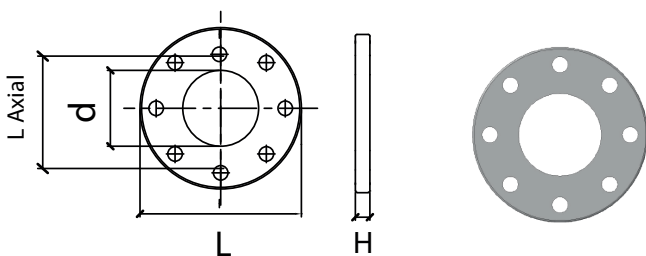

* Flange DN 50 threaded G 2"
 ** Flange DN 80 threaded G 3"
 *** Flange DN 100 threaded G 4"

Legend

α	Angular
C	Socket depth
C1	Socket depth 1
D	Socket diameter
D1	Socket diameter 1
Dp	Hollow mill driving diameter
Dpt	Largeness
d	Thread diameter
d1	Thread diameter 1
d2	Thread diameter 2
d3	Thread diameter 3
E	Overall outside diameter ring nut
E1	Overall outside diameter ring nut 1
Gr	Weight in grams
H	Height
On	holes number
L	Length
L1	Length 1
L2	Length 2
L Axial	Axial Length / Wheelbase
l	Misalignment
l1	Misalignment 1
r	Curvature radius (max)



See video
QL Aluminium

QLFLEX		Compensator hose, male connection				
Code	Gr	D	< r >		l1*	L
QLFLEX020	568	20	15	20	± 100	800
QLFLEX025	810	25	18	25	± 140	820
QLFLEX032	1400	32	23	32	± 180	960
QLFLEX040	2000	40	29	38	± 180	1210
QLFLEX050	4200	50	36	47	± 220	1440
QLFLEX063	6000	63	45	59	± 240	1690

* axial seismic movement

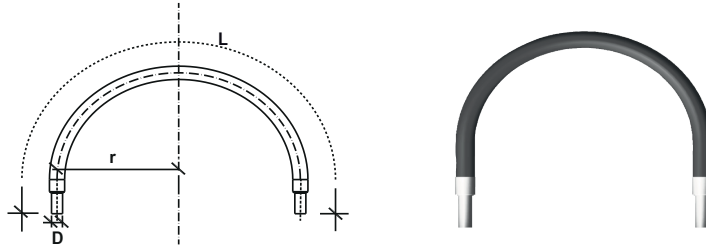

QLFLEXM		Compensator hose, male/threaded connection				
Code	Gr	D	< r >		l1*	L
QLFLEXM020048	568	20x1/2"	15	2	± 100	800
QLFLEXM020068	593	20x3/4"	15	20	± 100	815
QLFLEXM025088	819	25x1"	18	25	± 140	825
QLFLEXM032108	1400	32x1.1/4"	23	32	± 180	980
QLFLEXM040128	2000	40x1.1/2"	29	38	± 180	1210
QLFLEXM050168	4200	50x2"	36	47	± 220	1440
QLFLEXM063208	6000	63x2.1/2"	45	59	± 240	1690

* axial seismic movement

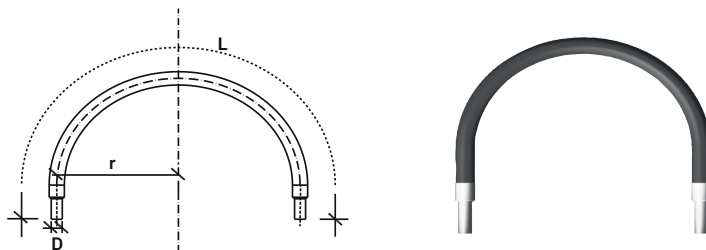

Quick Line Accessories

DIRDIL	Expansion joint, flanged					
Code	Gr.	D	L	L1	L Axial	On
DIRDIL063DIN	4600	63	130	165	125	4
DIRDIL080DIN	8000	80	130	200	160	8
DIRDIL110DIN	7600	110	130	220	180	8
DIRDIL168DIN	12400	168	130	285	240	8
DIRDIL220DIN	17700	220	130	340	295	12

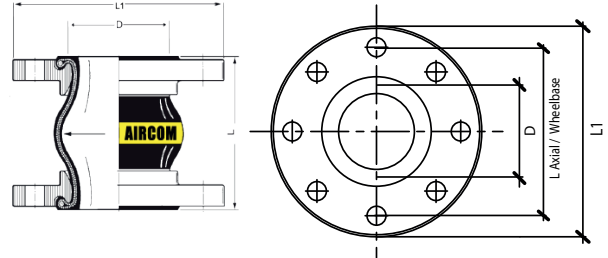
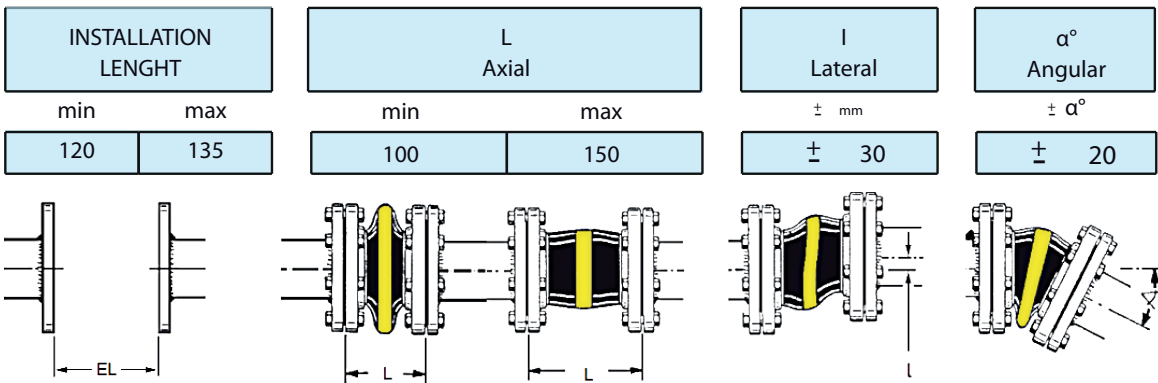

Table of minimum and maximum tolerance



Union Flanged-Flanged

- The flanged expansion joint is serrated through screw assemblies M16x55 (in galvanized steel 8.8) or M16x55 (in stainless steel A 2.70)
- Screwing torque is 40 Nm for all sizes
- Do not use any solvents, glues, lubricants of any kind for the assembly

pressure rating correction chart

working temperature	50°	70°	100°	
allowed movements depending on temperature	100%	80%	60%	
working pressure depending on temperature	PN 16	16 bar	12 bar	10 bar

- Expansion joints in High-Tech design suitable for compressed fluids
- Temperature (depending on medium) range -20°C up to +90°C, temporarily up to +100°C
- Electrically conductive

Legend

α	Angular
C	Socket depth
C1	Socket depth 1
D	Socket diameter
D1	Socket diameter 1
Dp	Hollow mill driving diameter
Dpt	Largeness
d	Thread diameter
d1	Thread diameter 1
d2	Thread diameter 2
d3	Thread diameter 3
E	Overall outside diameter ring nut
E1	Overall outside diameter ring nut 1
Gr	Weight in grams
H	Height
On	holes number
L	Length
L1	Length 1
L2	Length 2
L Axial	Axial Length / Wheelbase
l	Misalignment
l1	Misalignment 1
r	Curvature radius (max)

- Liner** - NBR (nitrile), seamless, abrasion resistant
- Reinforcement** -PA textile cord
- Cover** - Chloroprene CR
- Marking** - Yellow band, diameter, production date,...
- Flanges** - Swiveling, DIN PN 16, carbon steel, zinc plated

DIRFEM8CF		Bracket M8 thread insert pieces				
Code	Gr	D	L	H	F	Dpt
DIRFEM8016CF	9	16	31	35	9	30
DIRFEM8020CF	20	20	31	35	9	30
DIRFEM8025CF	30	25	38	35	9	30
DIRFEM8032CF	70	32	49	35	9	30
DIRFEM8040CF	80	40	60	70	9	40
DIRFEM8050CF	85	50	75	70	9	40
DIRFEM8063CF	110	63	94	70	9	40
DIRFEM8075CF	260	75	118	100	9	49
DIRFEM8080CF	250	80	120	100	9	49
DIRFEM8090CF	240	90	120	100	9	49
DIRFEM8110CF	330	110	163	100	9	49
DIRFEM168CF	403	168,3	225	105	M8/M10	160
DIRFEM220CF	645	220	280	135	M8/M10	215

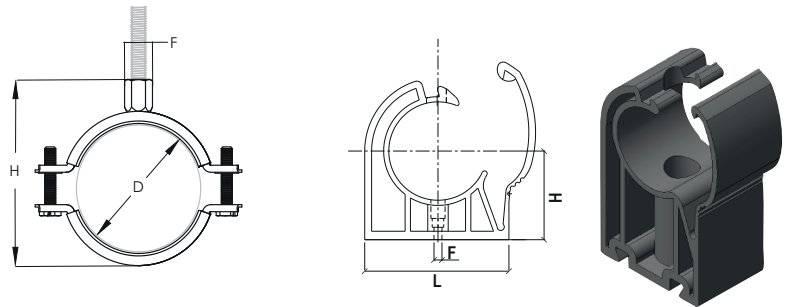

DIRSPE		Spacers				
Code	Gr	D	L	H	F	Dpt
DIRSPE020032	19	20-32	49	35	9	30
DIRSPE040063	55	40-63	94	30	9	40

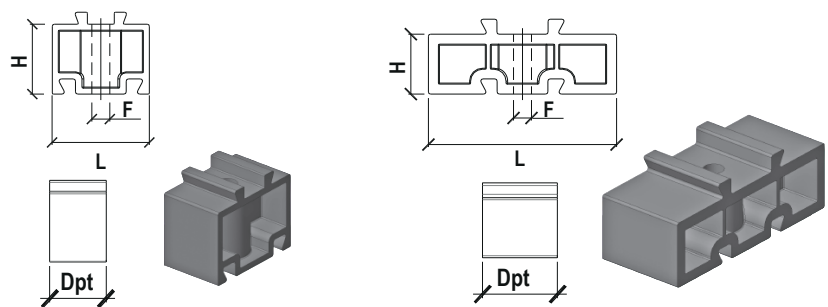

DIRSM		Debruers and Reamers	
Code	Gr.	D	
DIRSM016050	441	16-50	
DIRSM063110	1753	63-110	



QLCLEAL		Quick Line nut wrench for Aircom fittings, aluminium body		
Code	Gr.	D	D1	
QLCLEAL020025	72	20	25	
QLCLEAL032040	90	32	40	
QLCLEAL050	350	50		
QLCLEAL063	368	63		
QLCLEAL080	539	80		



See video
QL Aluminium

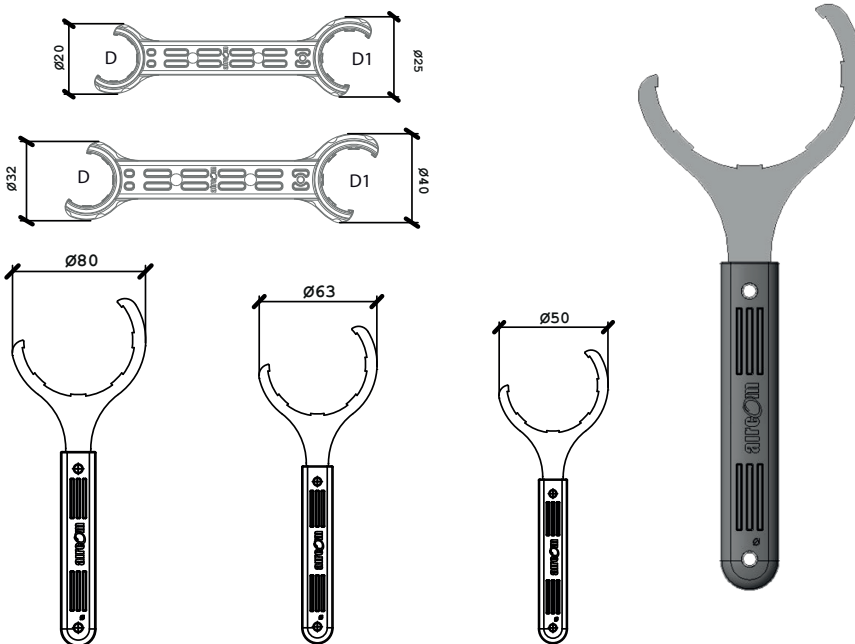

Legend

α	Angular
C	Socket depth
C1	Socket depth 1
D	Socket diameter
D1	Socket diameter 1
Dp	Hollow mill driving diameter
Dpt	Largeness
d	Thread diameter
d1	Thread diameter 1
d2	Thread diameter 2
d3	Thread diameter 3
E	Overall outside diameter ring nut
E1	Overall outside diameter ring nut 1
Gr	Weight in grams
H	Height
On	holes number
L	Length
L1	Length 1
L2	Length 2
L Axial	Axial Length / Wheelbase
I	Misalignment
I1	Misalignment 1
r	Curvature radius (max)

QLMISAL		Pipe-fittings insertion meter D 20-110 (in aluminium)	
Code	Gr.	D	
QLMISAL020110	92	20-110	



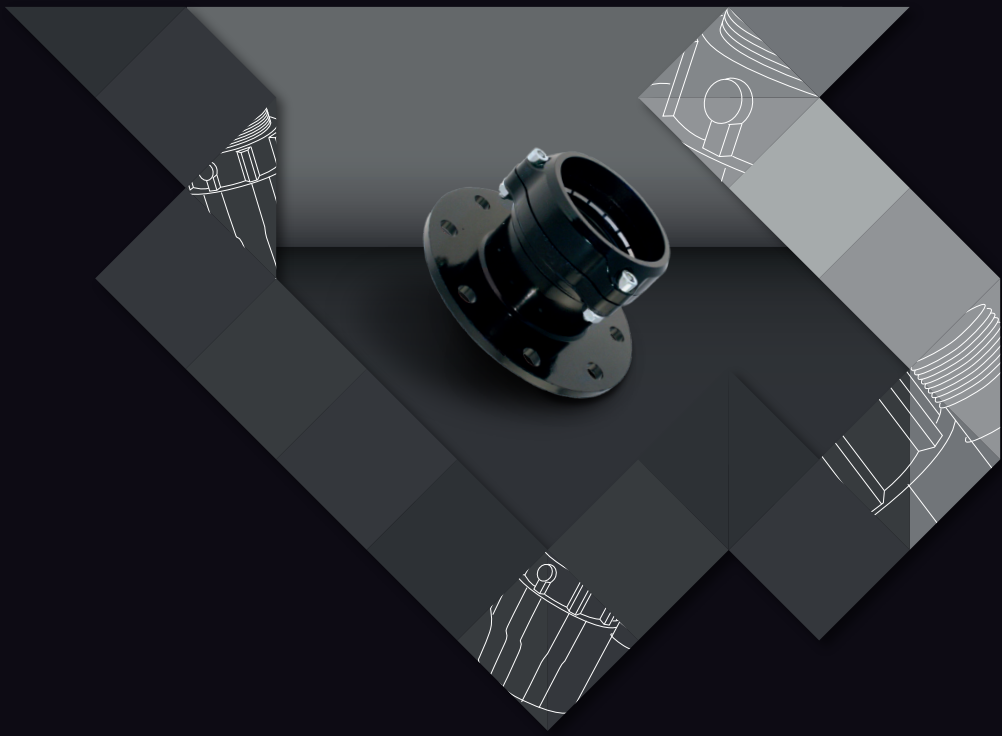

QUICK EASY RELIABLE

ANNEX B

QUICK LINE SYSTEM TECHNICAL DATA SHEETS



C028 - 2022

Aluminium Pipes diam 16 ÷ 220 mm

QLTUAL		Blue Aluminium pipe		
Code	Gr/m	D	bar length	sp
QLTUAL4016S	180	16	4	1
QLTUAL4020S	201	20	4	1,3
QLTUAL020S	201	20	5,8	1,3
QLTUAL4025S	273	25	4	1,4
QLTUAL025S	273	25	5,8	1,4
QLTUAL4032S	402	32	4	1,5
QLTUAL032S	402	32	5,8	1,5
QLTUAL4040S	586	40	4	1,8
QLTUAL040S	586	40	5,8	1,8
QLTUAL4050S	819	50	4	2
QLTUAL050S	819	50	5,8	2
QLTUAL4063S	1039	63	4	2
QLTUAL063S	1039	63	5,8	2
QLTUAL080S	1582	80	5,8	2,4
QLTUAL110S	2367	110	5,8	2,6
QLTUAL168S	5000	168,3	5,8	3,5
QLTUAL220S	6100	220	5,8	4

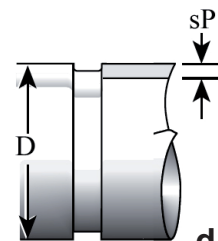
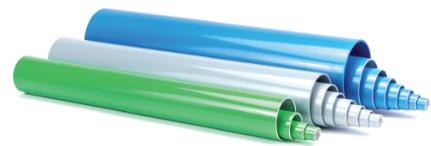
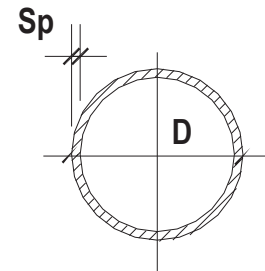

d. 168,3
d. 220 mm

QLTUALGY		Grey aluminium pipe		
Code	Gr/m	D	bar length	sp
QLTUALGY020S	201	20	5,8	1,3
QLTUALGY025S	273	25	5,8	1,4
QLTUALGY032S	402	32	5,8	1,5
QLTUALGY040S	586	40	5,8	1,8
QLTUALGY050S	819	50	5,8	2
QLTUALGY063S	1039	63	5,8	2
QLTUALGY080S	1582	80	5,8	2,4

QLTUALG		Green Aluminium pipe		
Code	Gr/m	D	bar length	sp
QLTUALG020S	201	20	5,8	1,5
QLTUALG025S	273	25	5,8	1,5
QLTUALG040S	586	40	5,8	2
QLTUALG063S	1039	63	5,8	2

QLSCI		Double Bend (Aluminium), Blue		
Code	Gr	D	L	l
QLSCI016	70	16	400	120
QLSCI020	100	20	430	150
QLSCI025	130	25	460	180

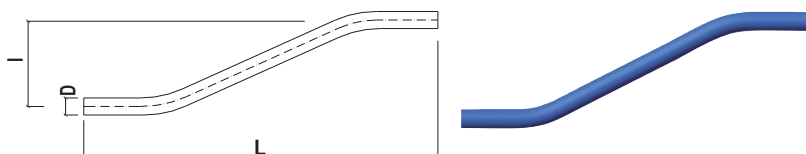

Quick Line Fittings diam 16 ÷ 63 mm

P
O
L
Y
M
E
R

QLMAPA	Coupling				
Code	Gr	D	L	E	C
QLMAPA016	50	16	81	37	38,80
QLMAPA020	90	20	98	45	49,80
QLMAPA025	132	25	106	51	54,80
QLMAPA032	212	32	124	61	61,90
QLMAPA040	350	40	142	75	71,00
QLMAPA050	505	50	161	87	79,70
QLMAPA063	570	63	170	108	79,50

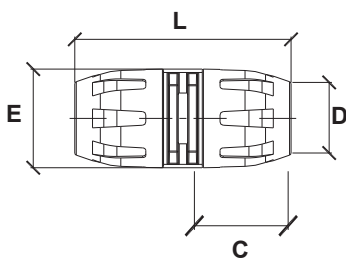

See video
16 ÷ 63 mm

QLMASPA	Sliding Coupling				
Code	Gr	D	L	E	C
QLMASPA032	212	32	124	61	61,90
QLMASPA040	350	40	142	75	71,00
QLMASPA050	505	50	161	87	79,70
QLMASPA063	570	63	170	108	79,50

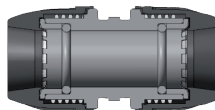
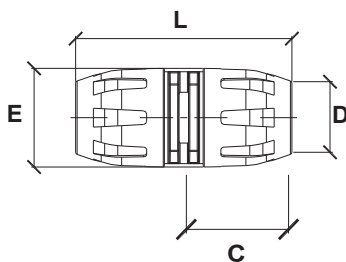

Legend

α	Angular
C	Socket depth
C1	Socket depth 1
D	Socket diameter
D1	Socket diameter 1
Dp	Hollow mill driving diameter
Dpt	Largeness
d	Thread diameter
d1	Thread diameter 1
d2	Thread diameter 2
d3	Thread diameter 3
E	Overall outside diameter ring nut
E1	Overall outside diameter ring nut 1
Gr	Weight in grams
H	Height
On	holes number
L	Length
L1	Length 1
L2	Length 2
L Axial	Axial Length / Wheelbase
l	Misalignment
l1	Misalignment 1
r	Curvature radius (max)

QUICK LINE SYSTEM TECHNICAL SCHEDULE

QLGO90PA		90° Elbow				
Code	Gr	D	L	E	C	
QLGO90PA016	70	16	72	37	38,80	
QLGO90PA020	100	20	86	45	49,80	
QLGO90PA025	140	25	95	51	54,80	
QLGO90PA032	240	32	122	61	61,90	
QLGO90PA040	390	40	130	75	71,00	
QLGO90PA050	580	50	152	87	79,70	
QLGO90PA063	800	63	165	108	79,50	

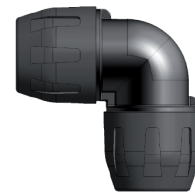
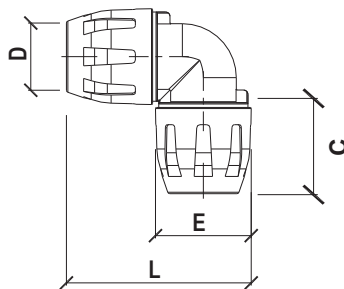

QLGO45PA		45° Elbow				
Code	Gr	D	L	H	E	C
QLGO45PA020	100	20	104	72	45	49,80
QLGO45PA025	145	25	115	81	51	54,80
QLGO45PA032	235	32	137	97	61	61,90
QLGO45PA040	375	40	160	115	75	71,00
QLGO45PA050	540	50	185	134	87	79,70
QLGO45PA063	770	63	210	140	108	79,50

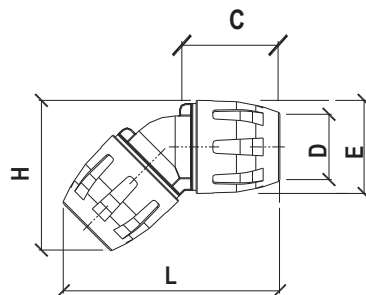



See video
16 ÷ 63 mm

QLTEPA	90° Tee					
Code	Gr	D	L	E	H	C
QLTEPA016	90	16	109	37	73	38,80
QLTEPA020	160	20	127	45	86	49,80
QLTEPA025	210	25	140	51	95	54,80
QLTEPA032	360	32	170	61	122	61,90
QLTEPA040	565	40	185	75	130	71,00
QLTEPA050	850	50	216	87	152	79,70
QLTEPA063	1200	63	235	108	180	79,50

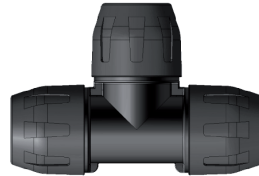
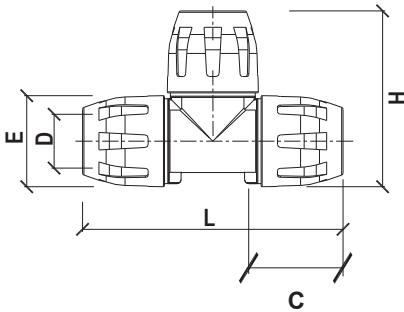

QLTRPA	Reducing Tee								
Codice	Gr	D	D1	L	E	E1	H	C	C1
QLTRPA020016	150	20	16	127	45	38	80	48	49,80
QLTRPA025016	200	25	16	140	52	38	88	52	49,80
QLTRPA025020	210	25	20	140	52	45	98	52	54,80
QLTRPA032020	340	32	20	170	62	45	111	62	61,90
QLTRPA032025	340	32	25	170	62	52	113	62	61,90
QLTRPA040020	494	40	20	186	76	45	123	70	71,00
QLTRPA040025	510	40	25	185	76	52	128	70	71,00
QLTRPA040032	540	40	32	185	76	62	131	70	71,00
QLTRPA050020	738	50	20	220	88	45	137	81	79,70
QLTRPA050025	735	50	25	220	88	52	138	81	79,70
QLTRPA050032	760	50	32	220	88	62	147	79	79,70
QLTRPA050040	820	50	40	220	88	76	150	79	79,70
QLTRPA063020	1027	63	20	235	108	45	153	80	79,50
QLTRPA063025	1041	63	25	235	108	52	153	80	79,5
QLTRPA063040	820	63	40	235	108	76	160	80	79,50
QLTRPA063050	1120	63	50	235	108	87	168	80	79,50

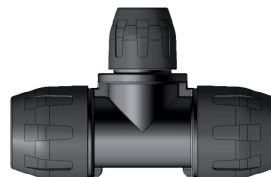
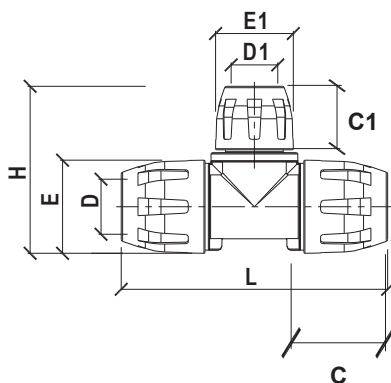

Legend

α	Angular
C	Socket depth
C1	Socket depth 1
D	Socket diameter
D1	Socket diameter 1
Dp	Hollow mill driving diameter
Dpt	Largeness
d	Thread diameter
d1	Thread diameter 1
d2	Thread diameter 2
d3	Thread diameter 3
E	Overall outside diameter ring nut
E1	Overall outside diameter ring nut 1
Gr	Weight in grams
H	Height
On	holes number
L	Length
L1	Length 1
L2	Length 2
L Axial	Axial Length / Wheelbase
I	Misalignment
I1	Misalignment 1
r	Curvature radius (max)

QLTPPA		90° threaded Tee					
Code	Gr	D	d	L	E	H	C
QLTPPA020048	160	20	1/2"	127	45	75	49,80
QLTPPA025048	210	25	1/2"	140	51	80	54,80

NPT thread available

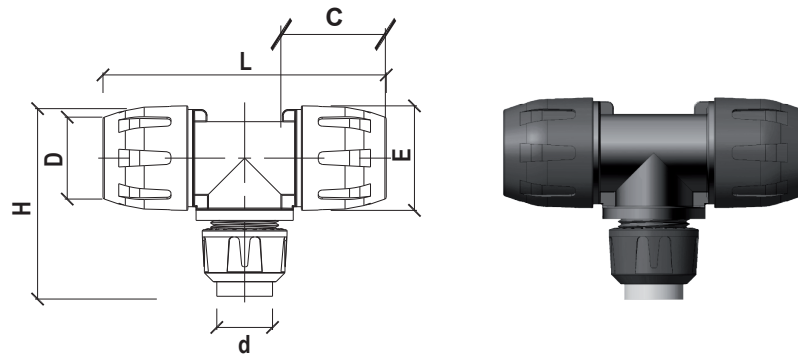

QLCAPA		End Cap			
Code	Gr	D	L	E	C
QLCAPA016	30	16	50	37	38,80
QLCAPA020	58	20	54	45	49,80
QLCAPA025	75	25	60	51	54,80
QLCAPA032	126	32	71	61	61,90
QLCAPA040	200	40	78	75	71,00
QLCAPA050	298	50	85	87	79,70
QLCAPA063	350	63	90	108	79,50

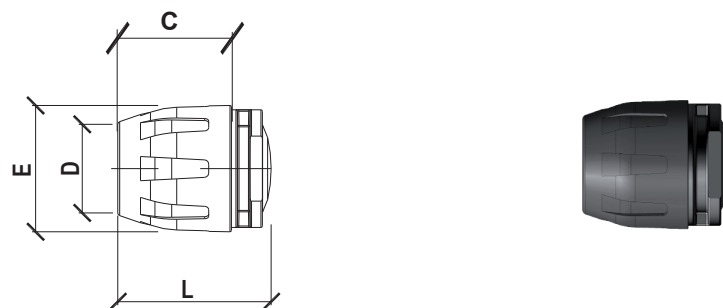

P
O
L
Y
M
E
R



See video
16 ÷ 63 mm

QLRIDPA	Reduction								
	Code	Gr	D	D1	L	E	E1	C	C1
QLRIDPA020016	100	20	16	X	45	37	49,80	38,80	
QLRIDPA025020	120	25	20	101	51	45	54,80	49,80	
QLRIDPA032025	178	32	25	115	61	51	61,90	54,80	
QLRIDPA040025	230	40	25	125	75	61	71,00	54,80	
QLRIDPA040032	290	40	32	133	75	51	71,00	61,90	
QLRIDPA050040	450	50	40	151	87	75	79,70	71,00	
QLRIDPA063040	710	63	40	X	108	75	79,50	71,00	
QLRIDPA063050	710	63	50	X	108	87	79,50	79,70	

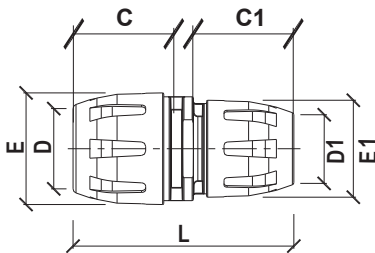

QLGO90PM	90° Elbow, male thread						
	Code	Gr.	D	d	L	E	C
QLGO90PM020048	68	20	1/2"	78	45	49,80	
QLGO90PM025048	95	25	1/2"	87	51	54,80	
QLGO90PM025068	95	25	3/4"	87	51	54,80	

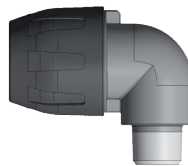
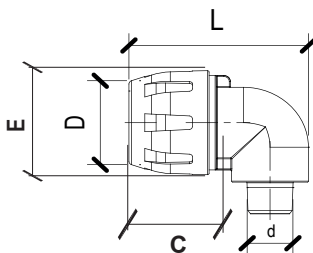

Legend

α	Angular
C	Socket depth
C1	Socket depth 1
D	Socket diameter
D1	Socket diameter 1
Dp	Hollow mill driving diameter
Dpt	Largeness
d	Thread diameter
d1	Thread diameter 1
d2	Thread diameter 2
d3	Thread diameter 3
E	Overall outside diameter ring nut
E1	Overall outside diameter ring nut 1
Gr	Weight in grams
H	Height
On	holes number
L	Length
L1	Length 1
L2	Length 2
L Axial	Axial Length / Wheelbase
I	Misalignment
I1	Misalignment 1
r	Curvature radius (max)

QUICK LINE SYSTEM TECHNICAL SCHEDULE

QLMNPA	Union, male threaded					
Code	Gr	D	d	L	E	C
QLMNPA016048	30	16	1/2"	64	37	38,80
QLMNPA020048	60	20	1/2"	68	45	49,80
QLMNPA020068	60	20	3/4"	68	45	49,80
QLMNPA025048	80	25	1/2"	71	51	54,80
QLMNPA025068	80	25	3/4"	73	51	54,80
QLMNPA025088	80	25	1"	76	51	54,80
QLMNPA032088	120	32	1"	85	61	61,90
QLMNPA032108	130	32	1.1/4"	87	61	61,90
QLMNPA040088	200	40	1"	96	75	71,00
QLMNPA040108	200	40	1.1/4"	97	75	71,00
QLMNPA040128	200	40	1.1/2"	98	75	71,00
QLMNPA050128	300	50	1.1/2"	108	87	79,70
QLMNPA050168	290	50	2"	111	87	79,70
QLMNPA063168	350	63	2"	115	108	79,50

NPT thread available

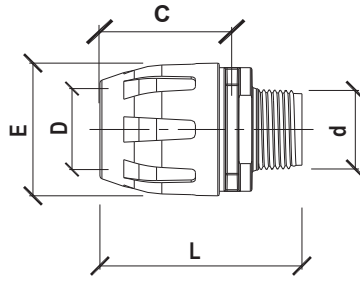

Quick Line valves

QLVAM	Quick Line male threaded connection ball valve						
Code	Gr.	D	d	L	H	E	C
QLVAM016048	0,220	16	1/2"	103	60	37	38,80

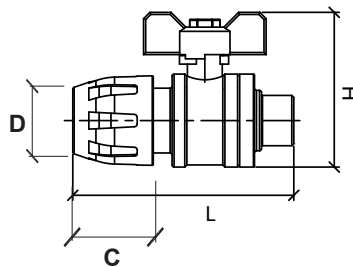
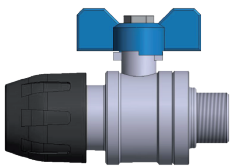

POLYMER



See video
16 ÷ 63 mm

QLVAF	Quick Line female threaded connection ball valve						
Code	Gr.	D	d	L	H	E	C
QLVAF016048	0,220	16	1/2"	103	60	37	38,80

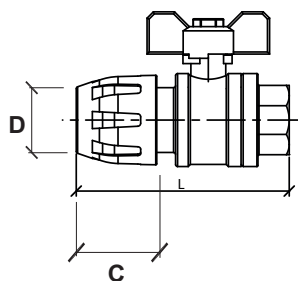
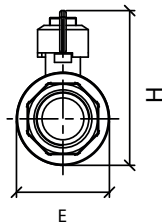
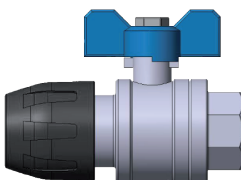

Legend

α	Angular
C	Socket depth
C1	Socket depth 1
D	Socket diameter
D1	Socket diameter 1
Dp	Hollow mill driving diameter
Dpt	Largeness
d	Thread diameter
d1	Thread diameter 1
d2	Thread diameter 2
d3	Thread diameter 3
E	Overall outside diameter ring nut
E1	Overall outside diameter ring nut 1
Gr	Weight in grams
H	Height
On	holes number
L	Length
L1	Length 1
L2	Length 2
L Axial	Axial Length / Wheelbase
I	Misalignment
I1	Misalignment 1
r	Curvature radius (max)

QUICK LINE SYSTEM TECHNICAL SCHEDULE

Quick Line Fittings diam 63 ÷ 110 mm

* Flange DN 50 threaded G 2"
 ** Flange DN 80 threaded G 3"
 *** Flange DN 100 threaded G 4"

QLMFLAL		Flanged Coupling					
Code	Gr.	D	E	L	H	L Axial	C
QLMFLAL063168 *	1269	63	97	165	125	125	95
QLMFLAL080248 **	1783	80	116	200	135	160	114

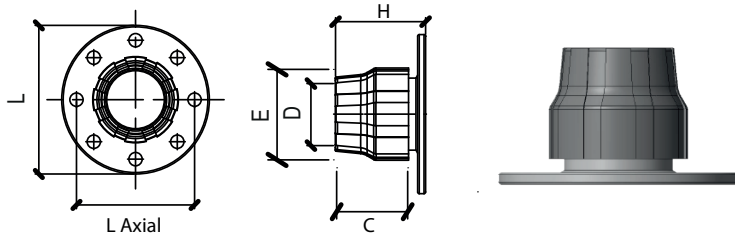

QLMFLAL		Flanged Coupling					
Code	Gr.	D	E	L	H	L Axial	C
QLMFLAL110328	2400	110	153	220	123	180	106

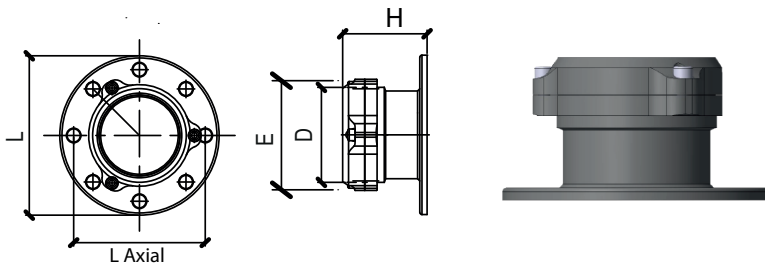

QLTFLAL		Flanged Tip				
Code	Gr.	D	L	H	L Axial	C
QLTFLAL80208 **	1823	80	227	172	160	114
QLTFLAL110248 ***	2610	110	227	180	180	106

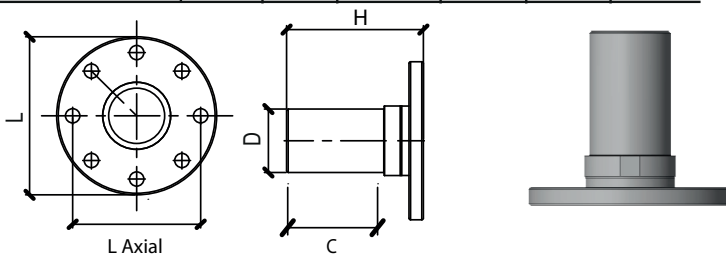

QLRIDTU		Reduction pipe, male/male connection			
Code	Gr.	D	D1	L	
QLRIDTU110050	2432,5	110	50	261	
QLRIDTU110063	2186,1	110	63	276	
QLRIDTU110080	2160,9	110	80	282	



Legend

α	Angular
C	Socket depth
C1	Socket depth 1
D	Socket diameter
D1	Socket diameter 1
Dp	Hollow mill driving diameter
Dpt	Largeness
d	Thread diameter
d1	Thread diameter 1
d2	Thread diameter 2
d3	Thread diameter 3
E	Overall outside diameter ring nut
E1	Overall outside diameter ring nut 1
Gr	Weight in grams
H	Height
On	holes number
L	Length
L1	Length 1
L2	Length 2
L Axial	Axial Length / Wheelbase
l	Misalignment
l1	Misalignment 1
r	Curvature radius (max)

POLYMER



See video
Quick branch plugs

DIRDERFF		Quick branch plug, f thread outlet (aluminium)						
Code	Gr	D	d	L	E	L1	Dp	L Axial
DIRDERFF025048	238	25	1/2"	113	45	52	16	24,5
DIRDERFF032048	217	32	1/2"	113	45	52	16	24,5
DIRDERFF040048	274	40	1/2"	125	45	52	20	29,6
DIRDERFF040068	302	40	3/4"	125	51	52	20	29,6
DIRDERFF050048	402	50	1/2"	145	45	60	20	31
DIRDERFF050068	487	50	3/4"	145	51	60	20	31
DIRDERFF063048	368	63	1/2"	145	45	60	20	43
DIRDERFF063068	396	63	3/4"	145	51	60	20	43
DIRDERFF063088	620	63	1"	148	61	60	20	43
DIRDERFF080048	1191	80	1/2"	220	45	63	20	71
DIRDERFF080068	1153	80	3/4"	220	51	63	20	71
DIRDERFF080088	1160	80	1"	220	61	63	20	71
DIRDERFF110068	900	110	3/4"	220	51	63	20	71
DIRDERFF110088	900	110	1"	220	61	63	20	71

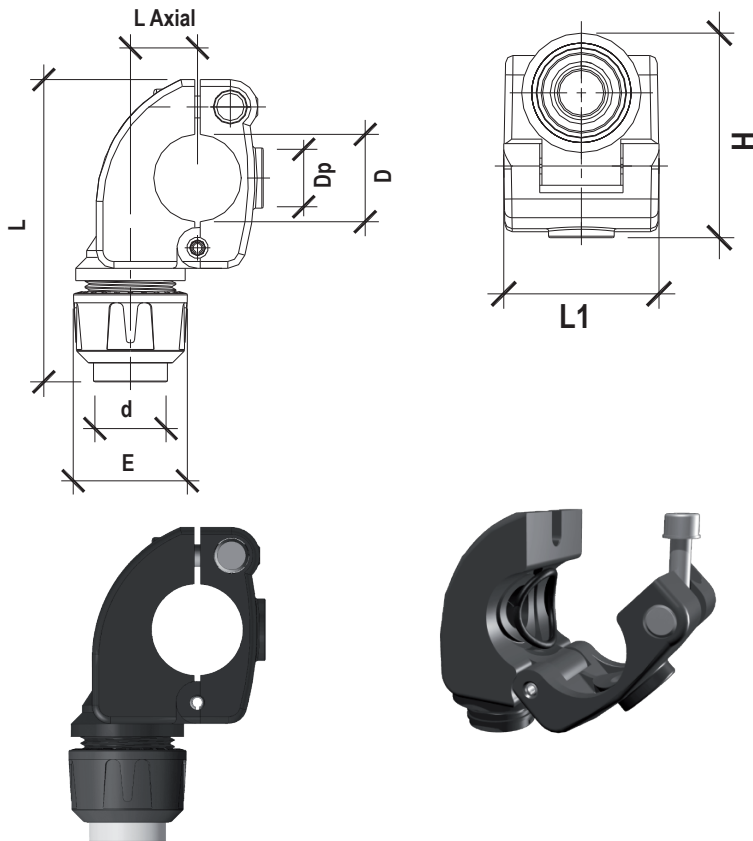

Legend

α	Angular
C	Socket depth
C1	Socket depth 1
D	Socket diameter
D1	Socket diameter 1
Dp	Hollow mill driving diameter
Dpt	Largeness
d	Thread diameter
d1	Thread diameter 1
d2	Thread diameter 2
d3	Thread diameter 3
E	Overall outside diameter ring nut
E1	Overall outside diameter ring nut 1
Gr	Weight in grams
H	Height
On	holes number
L	Length
L1	Length 1
L2	Length 2
L Axial	Axial Length / Wheelbase
l	Misalignment
l1	Misalignment 1
r	Curvature radius (max)

QUICK LINE SYSTEM TECHNICAL SCHEDULE

Quick Line Accessories

QLPUNM	Male threaded Quick Line Spigot (aluminium)			
Code	Gr.	D	d	L
QLPUNM016038	20	16	3/8"	76,5
QLPUNM020048	39	20	1/2"	94,5
QLPUNM020068	54	20	3/4"	96
QLPUNM025088	86	25	1"	108
QLPUNM032108	168	32	1.1/4"	125
QLPUNM040128	175	40	1.1/2"	136
QLPUNM050168	390	50	2"	148
QLPUNM063168	477	63	2"	158
QLPUNM080248	732	80	3"	171,5

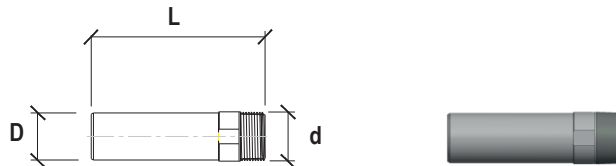

QLFLEX	Compensator hose, male connection					
Code	Gr	D	< r >		l1*	L
QLFLEX020	809	20	15	20	± 100	800
QLFLEX025	925	25	18	25	± 140	820
QLFLEX032	1200	32	23	32	± 180	960
QLFLEX040	1580	40	29	38	± 180	1200
QLFLEX050	3400	50	36	47	± 220	1430
QLFLEX063	4800	63	45	59	± 240	1650

* axial seismic movement

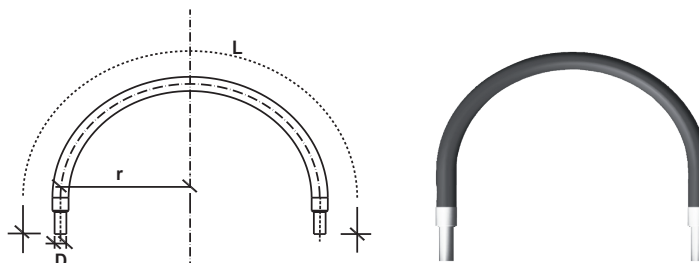

DIRFEM8CF		Bracket M8 thread insert pieces				
Code	Gr	D	L	H	F	Dpt
DIRFEM8016CF	9	16	31	35	9	30
DIRFEM8020CF	20	20	31	35	9	30
DIRFEM8025CF	30	25	38	35	9	30
DIRFEM8032CF	70	32	49	35	9	30
DIRFEM8040CF	80	40	60	70	9	40
DIRFEM8050CF	85	50	75	70	9	40
DIRFEM8063CF	110	63	94	70	9	40
DIRFEM8075CF	260	75	118	100	9	49
DIRFEM8080CF	250	80	120	100	9	49
DIRFEM8090CF	240	90	120	100	9	49
DIRFEM8110CF	330	110	163	100	9	49

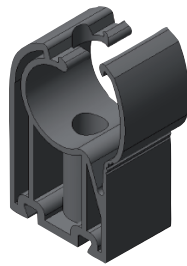
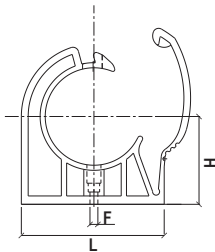

DIRSPE		Spacers				
Code	Gr	D	L	H	F	Dpt
DIRSPE020032	19	20-32	49	35	9	30
DIRSPE040063	55	40-63	94	30	9	40

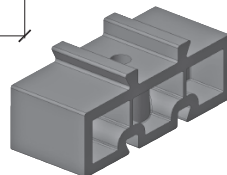
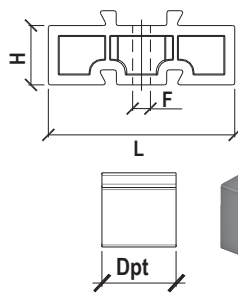
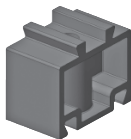
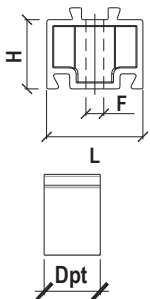

Legend

α	Angular
C	Socket depth
C1	Socket depth 1
D	Socket diameter
D1	Socket diameter 1
Dp	Hollow mill driving diameter
Dpt	Largeness
d	Thread diameter
d1	Thread diameter 1
d2	Thread diameter 2
d3	Thread diameter 3
E	Overall outside diameter ring nut
E1	Overall outside diameter ring nut 1
Gr	Weight in grams
H	Height
On	holes number
L	Length
L1	Length 1
L2	Length 2
L Axial	Axial Length / Wheelbase
l	Misalignment
l1	Misalignment 1
r	Curvature radius (max)

Quick Line Tools

QLCLE	Quick Line nut wrench for Aircom fittings	
Code	Gr.	D
QLCLE016020	0,065	16-20
QLCLE025032	0,090	25-32
QLCLE040050	0,090	40-50
QLCLE063	0,150	63

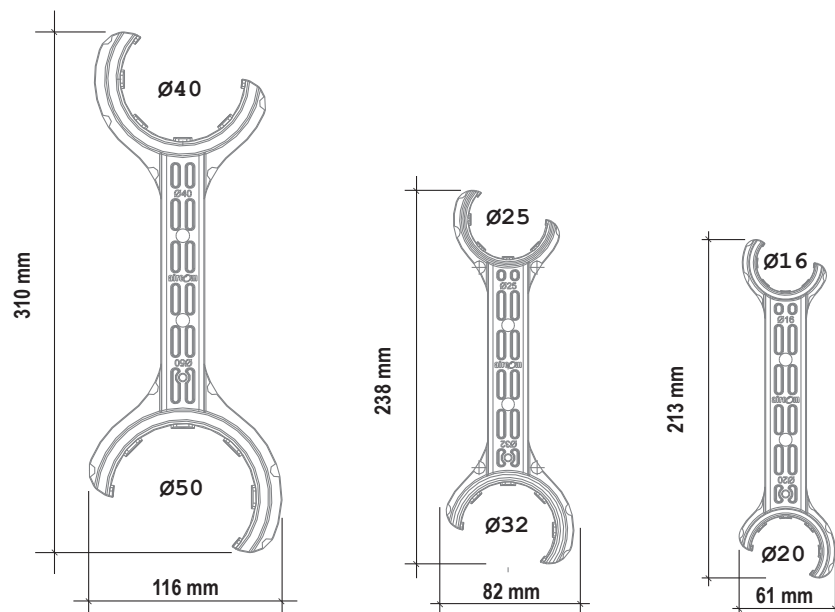

QLMIS		Pipe-fittings insertion meter D 16-80	
Code	Gr.	D	
QLMIS016080	84,7	16-80	

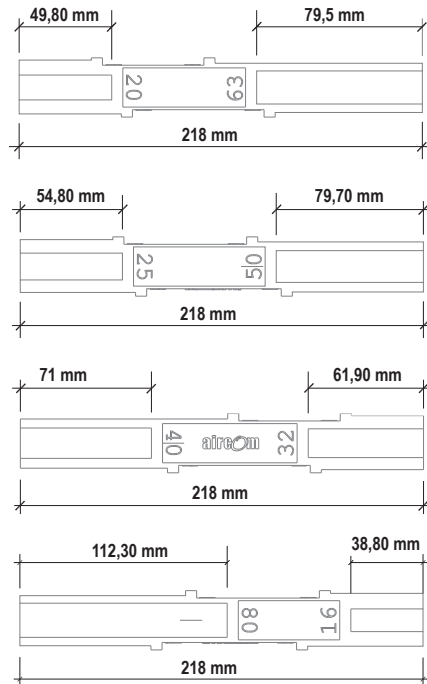

DIRSM		Deburbers and Reamers	
Code	Gr.	D	
DIRSM016050	558,70	16-50	
DIRSM063110	1747,50	63-110	



Legend

α	Angular
C	Socket depth
C1	Socket depth 1
D	Socket diameter
D1	Socket diameter 1
Dp	Hollow mill driving diameter
Dpt	Largeness
d	Thread diameter
d1	Thread diameter 1
d2	Thread diameter 2
d3	Thread diameter 3
E	Overall outside diameter ring nut
E1	Overall outside diameter ring nut 1
Gr	Weight in grams
H	Height
On	holes number
L	Length
L1	Length 1
L2	Length 2
L Axial	Axial Length / Wheelbase
l	Misalignment
l1	Misalignment 1
r	Curvature radius (max)