

Directional Controls

Wet Armature Solenoid Operated Directional Control Valves

Model DG4V-5, 20 Series

Typical Construction of a
Spring-Centered DC Valve with
Variable Speed Pilot Control passage

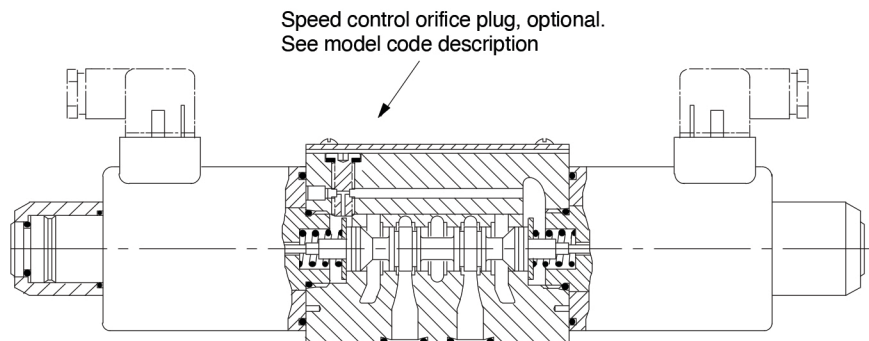

General Description

Max. pressure 315 bar (4500 psi)
Max. flow rates Up to 120 L/min
(32 USgpm),
dependent on spool
Mounting surface ISO 4401 size 05
NFFPA D02
DIN 24340 (NG10)

A range of four-port solenoid operated directional control valves with four-land spool design to facilitate provision of smooth, variable valve response speeds.

The range includes:

- AC and DC wet-armature solenoid options with ISO 4400 (DIN 43650) electrical connections and manual overrides.
- Variable speed changeover potential in all DC models; see "Response Times" section
- Many spool types; in spring-offset, spring-centered and detented arrangements.

5069.00/EN/0497/A

Functional Symbols

Double Solenoid Valves, Two-Position, Detented

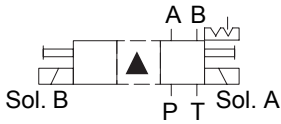

DG4V-5-*N valves



Double Solenoid Valves, Spring Centered

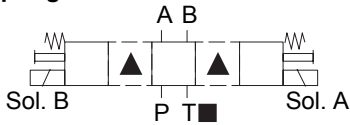

DG4V-5-*C valves

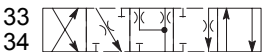
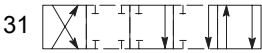
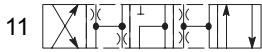
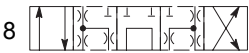
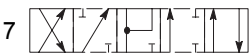
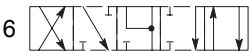
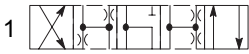
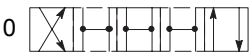

Single Solenoid Valves, Solenoid at Port A End

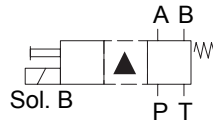

DG4V-5-*A valves



DG4V-5-*B valves

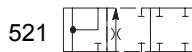
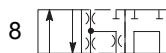

Single Solenoid Valves, Solenoid at Port B End

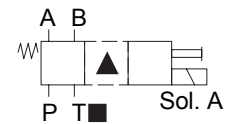

DG4V-5-*AL valves



DG4V-5-*BL valves

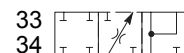
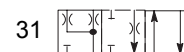
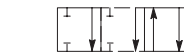
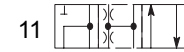
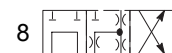
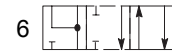
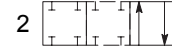
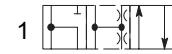
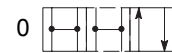

56

▲ Transient condition only.
■ Both ports T_A and T_B are available.

Model Code

(F13-) DG4V-5-*** *(L) (J) (-**)- (V) M- (S6)- U - ** 6- 20- J**

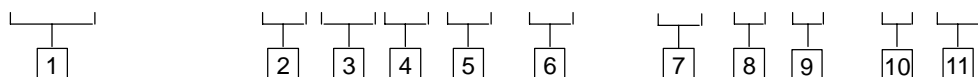

1 Prefix, fluid compatibility
 Blank = AC or DC-voltage models for petroleum oils, water-in-oil (invert) emulsions or phosphate esters.
 AC-voltage models for water glycols.
 F13 = DC-voltage models for water glycols.

2 Spool type
 See "Functional Symbols" section

3 Spool spring arrangement
 A = Spring-offset, end-to-end
 AL = As "A" but left-hand build
 B = Spring offset, end-to-center
 BL = As "B" but left-hand build
 C = Spring centered
 N = Two-position, detented
 See also "Functional Symbols" section

4 Spool design
 J = All DC valves except "0A" spool/spring arrangements.
 AC valves with "8B(L)" and "8C" spool/spring arrangements.
 Omit for "0A" DC-valves and all AC valves except "8B(L)" and "8C" spool/spring arrangements

5 Manual override option
 P = Standard overrides in both ends of single-solenoid valves
 H = Water-resistant override(s) in solenoid end(s) ▼
 H2 = Water-resistant overrides in both ends of single-solenoid valves
 Z = No overrides at either end
 Omit for standard plain override(s) in solenoid end(s) only ▼
 ▼ No override in non-solenoid end of single-solenoid valves.

6 Solenoid energization identity
 V = Solenoid "A" is at port A end and/or solenoid "B" is at port B end, independent of spool type
 Omit for US ANSI B93.9 standard requiring solenoid "A" to connect P to A when energized and/or solenoid "B" to connect P to B

7 Spool position indicator switch
 S6 - LVDT type DC switch with Pg7 connector plug

8 Electrical connection(s)
 U = ISO 4400 (DIN 43650) mounting(s) without plug(s)

9 Coil rating
 A = 110V AC 50
 C = 220V AC 50
 ED = 240V AC 50
 EK = 115V AC 60
 EH = 230V AC 60
 G = 12V DC
 H = 24V DC
 HL = 24V DC (32W)
 OJ = 48V DC
 P = 110V DC

10 Design number, 20 series
 Subject to change. Installation dimensions unaltered for design numbers 20 to 29 inclusive

11 Spool speed control
 J06 = 0,6 mm orifice
 J08 = 0,8 mm orifice
 J10 = 1,0 mm orifice
 J12 = 1,2 mm orifice
 J99 = no orifice. Must be specified where future fitting of orifice is required, see page A.11, "Spool Speed Control Orifice"

For Mounting Subplates and Fixing Bolt Kits
 See catalogs 2425 and 2314.

For Electrical Plug(s)
 See end of "Installation Dimensions" section.

Operating Data
Max. Pressures
 Ports P, A and B 315 bar (4500 psi)
 Ports T_A and T_B 120 bar (1750 psi) for AC sol.
 160 bar (2325 psi) for DC sol.

Control Data
 For coil ratings see [8] in "Model Code" section.

Power Consumption

AC Solenoids

	AC 50 Hz	AC 60 Hz
Inrush, max. ▲VA	700	750
Steady-state ▼VA	375	440
Holding VA	105	130

All above values are RMS
 ▲ Armature fully retracted, 1st half-cycle.
 ▼ At start of normal working stroke of valve spool. Previously called "Inrush".

DC Solenoids
 At rated voltage and wire temperature of 20°C (68°F):
 Type HL 32W
 Others 38-42W

Performance Data

Pressure Drops Typical with petroleum oil at 36 cSt (170 SUS) and a specific gravity of 0,87

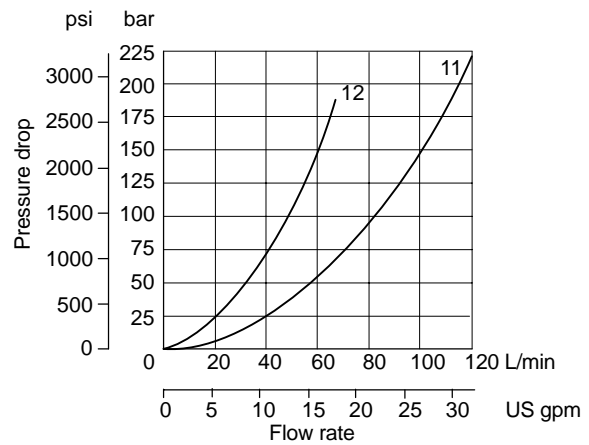
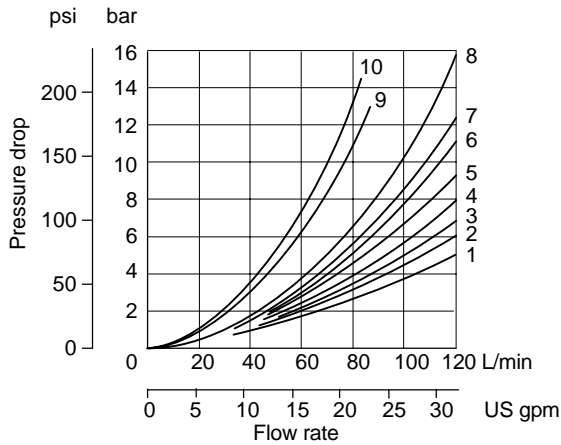

Spool/spring code	Spool positions covered	P to A	P to B	A to T	B to T	P to T	A to B or B to A
0A(L)	Both	2	2	4	5	–	–
0B(L) & 0C	De-energized	–	–	–	–	3▲	–
	Energized	1	1	6	7	–	–
1B(L) & 1C	De-energized	–	–	–	–	6▼	–
	Energized	1	2	6	4	–	–
2A(L)	Both	3	3	5	6	–	–
2B(L) & 2C	All	2	2	4	5	–	–
2N	Both	3	3	5	6	–	–
3B(L) & 3C	De-energized	–	–	5	–	–	–
	Energized	2	3	6	5	–	–
6B(L) & 6C	De-energized	–	–	5●	6▼	–	–
	Energized	3	3	6	7	–	–
6N	Both	4	4	4	5	–	–
7B(L) & 7C	De-energized	3●	3▼	–	–	–	5■
	Energized	2	2	5	6	–	–
8B(L) & 8C	All	2	2	7	8	8	–
11B(L) & 11C	De-energized	–	–	–	–	6●	–
	Energized	2	1	4	7	–	–
22A(L)	Both	3	3	–	–	–	–
23A(L)	Both	3	3	5	6	–	–
31B(L) & 31C	De-energized	–	–	–	6	–	–
	Energized	3	2	4	7	–	–
33B(L) & 33C	De-energized	–	–	12●	12▼	–	–
	Energized	2	2	5	6	–	–
34B(L) & 34C	De-energized	–	–	11●	11▼	–	–
	Energized	2	2	5	6	–	–
52BL & 52C	All	7●	8	4	–	–	9■
56BL & 56C	De-energized	–	–	8●	10▼	–	–
	Energized	7●	8	6	–	–	9■
521B & 521C	All	8	7▼	–	5	–	9■
561B & 561C	De-energized	–	–	10●	8▼	–	–
	Energized	8	7▼	–	7	–	9■

▲ A and B blocked ▼ A blocked ● B blocked ■ P blocked

Operating Data

Spool Position Indicator Models

Spool/spring arrangement types 0A (L), 2A(L), 22A(L)

DC model type "S6"



This product has been designed and tested to meet specific standards outlined in the European Electromagnetic Compatibility Directive (EMC) 89/336/EEC, amended by 91/263/EEC, 92/31/EEC and 93/68/EEC, article 5. For instructions on installation requirements to achieve effective protection levels see this leaflet and the Installation Wiring Practices for Vickers Electronic Products leaflet 2468. Wiring practices relevant to this Directive are indicated by

Electromagnetic Compatibility (EMC) .

Input:

Supply voltage	10 to 35V DC inclusive of a maximum 4V pk-to-pk ripple
Current, switch open	5 mA
Current, switch closed	255 mA

Output:

Voltage	1V below input at maximum load
Maximum continuous current	250 mA
Maximum load impedance	136Ω at maximum input volts
Maximum switching frequency	10 Hz

Plug connections:

Pin 1 (output 1)	Normally open (ie. not connected to pin 3)
Pin 2	Supply +ve
Pin 3	0V
Pin 4 (output 2)	Normally closed (ie. connected to pin 3)
Switching point	Within the spool spring offset condition ●
Connector	Pg7 plug (supplied with valve)
Protection	Overload and short-circuit protected; self re-setting. IEC 144 class IP65 with connector correctly fitted.

● Factory setting ensures this condition under all combinations of manufacturing tolerance and of temperature drift (see "Temperature Limits") .

Wiring Connections



Warning

All power must be switched off before connecting or disconnecting any plugs.

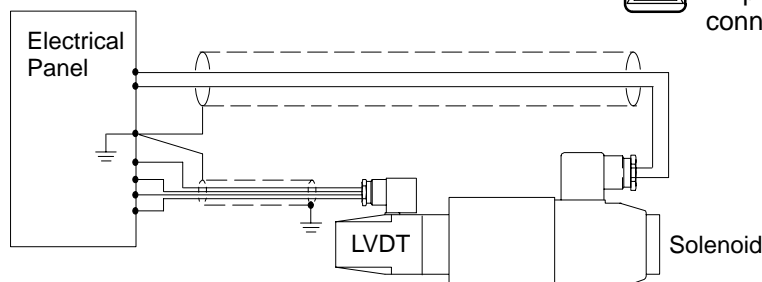

Customer's protective ground connection



WARNING: Electromagnetic Compatibility (EMC)

It is necessary to ensure that the unit is wired up in accordance with the connection arrangements shown above. For effective protection the user's electrical cabinet, the valve subplate or manifold and the cable screens should be connected to efficient ground points.

In all cases both valve and cable should be kept as far away as possible from any sources of electromagnetic radiation such as cables carrying heavy current, relays and certain kinds of portable radio transmitters, etc. Difficult environments could mean that extra screening may be necessary to avoid the interference.

Max. Flow Rates

Based on warm solenoid(s) operating at 10% below rated voltage.

Flow limits applicable to following usages:

1. All valves except those with types 22, 52, 56, 521 and 561 spools having simultaneous equal flow rates from P to A or B and from B or A to T.
2. Valves with type 22 spools having flow from P to A or B, the other being blocked. T is drained at all times.
3. Valves with types 52, 56, 521 and 561 spools having one service port connected to the full bore end of a 2:1 area ratio double-acting cylinder and the other service port to the annulus end.
4. Valves with type 23 spools having single flow from A or B to T, P and the other service port being blocked.

Consult Vickers with application details if any of the following are required:

- a) Single flow path, i.e. P to A, P to B, A to T or B to T.
- b) Substantially different simultaneous flow rates between P to A or B and B or A to T.
- c) Spools as in 3 above are to be used with cylinder ratios greater than about 3:1 at low flow rates or 2:1 at high flow rates.

AC Solenoid Valves

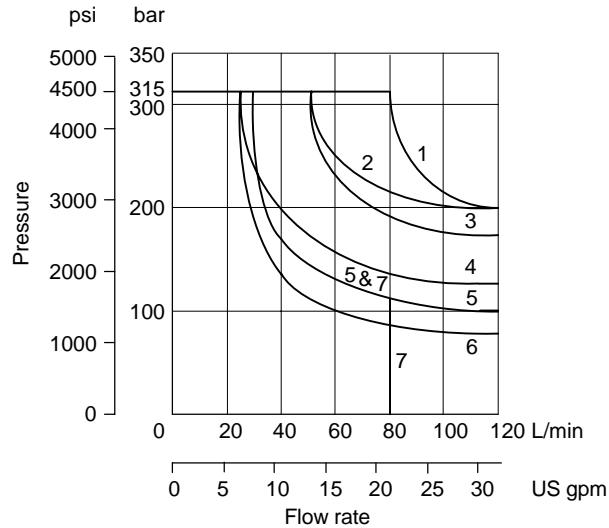

DC Solenoid Valves

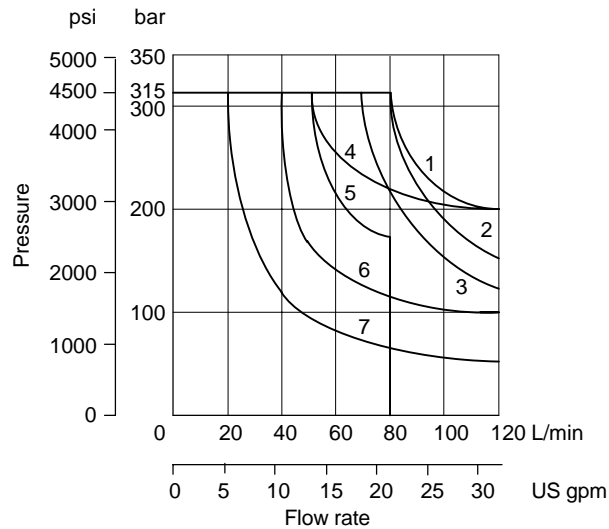

Spool/spring code	AC valve graph curve	DC valve graph curve
0A(L)	3	2
0B(L) & 0C	2	4
1B(L) & 1C	6	7
2A(L)	3	2
2B(L), 2C & 2N	1	1
3B(L), 3C, 6B(L) & 6C	4	6
6N	3	3
7B(L) & 7C	1	1
8B(L) & 8C	7	5
11B(L), 11C & 22A(L)	6	7
23A(L)	5	6
31B(L) & 31C	4	6
33B(L), 33C, 34B(L) & 34C	3	6
52B(L), 52C, 56BL, 56C, 521B, 521C, 561B & 561C	4	6

Response Times, Typical

Time taken from when signal is first applied at the solenoid until the spool completes its travel. Based on DG4V-5-2C at 60 L/min (16 USgpm) from P to A to B to T and at 160 bar (2320 psi) with petroleum oil at 36 cSt (168 SUS) and at 50°C (122°F):

- AC energizing 30 ms
- AC de-energizing 40 ms
- DC energizing 120 ms▲
- DC de-energizing 45 ms▲*

* *In pure switched conditions, devoid of the effects of any suppression diodes and full-wave rectifiers.*

▲ *DG4V-5-2CJ valves. Longer response times can be obtained by fitting an orifice plug in a special pilot port, standard in all bodies. An orifice kit 459065, containing a selection of plugs of differing orifice size, can be ordered separately. Ask your Vickers representative for details.*

Hydraulic Fluids

Water glycols can be used with F13-prefix DC-voltage models or with non-prefix AC-voltage models. Non-prefix DC-voltage models and all AC-voltage models can be used with anti-wear hydraulic oils, water-in-oil emulsions, phosphate esters (not alkyl based).

The extreme operating viscosity range is from 500 to 13 cSt (2300 to 70 SUS) but the recommended running range is 54 to 13 cSt (245 to 70 SUS).

For further information about fluids see catalog 920.

Temperature Limits

- Minimum ambient -20°C (-4°F)
- Maximum ambient:
 - AC 50 Hz valves 50°C (122°F)
 - AC 60 Hz valves 40°C (104°F)
 - DC valves 70°C (158°F)

Fluid temperatures

	Petroleum oil	Water-containing
Min.	-20°C (-4°F)	+10°C (+50°F)
Max.*	+70°C (+158°F)	+54°C (+130°F)

* *To obtain optimum service life from both fluid and hydraulic system, 65°C (150°F) normally is the maximum temperature except for water-containing fluids.*

For synthetic fluids consult manufacturer or Vickers where limits are outside those for petroleum oil.

Whatever the actual temperature range, ensure that viscosities stay within the limits specified in the "Hydraulic Fluids" section.

Solenoid Surface Temperatures

Typical maximums at 20°C (68°F) ambient:

- AC 50 Hz solenoids 80°C (176°F)
- AC 60 Hz solenoids 92°C (197°F)
- DC solenoids 78°C (172°F)

Contamination Control Requirements

Recommendations on contamination control methods and the selection of products to control fluid condition are included in Vickers publication 9132 or 561, "Vickers Guide to Systemic Contamination Control". The book also includes information on the Vickers concept of "ProActive Maintenance". The following recommendations are based on ISO cleanliness levels at 2 µm, 5 µm and 15 µm. For products in this catalog the recommended levels are:

- Up to 210 bar (3050 psi) 20/18/15
- Above 210 bar (3050 psi) 19/17/14

Mass, Approx. kg (lb)

- Single solenoid models, AC coils 4,0 (8.8)
- Single solenoid models, DC coils 4,8 (10.6)
- Double solenoid models, AC coils 4,5 (9.9)
- Double solenoid models, DC coils 6,3 (13.9)

Installation Dimensions in mm (inches)

AC Solenoid Models

3rd angle projection

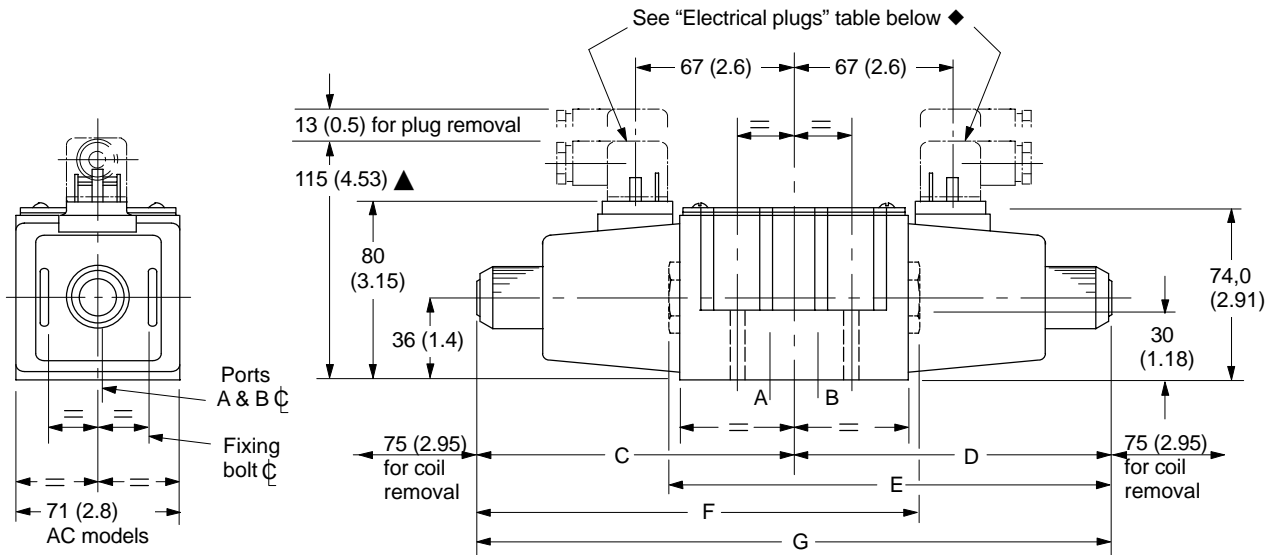
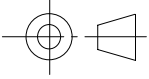

- ▲ May vary according to plug source.
- ◆ The cable entry can be repositioned at 90° intervals from the position shown. This is done by reassembling the contact holder into the appropriate position inside the plug housing.

Model	Solenoid at:	C	D	E	F	G
DG4V-5-*A(L)/B(L)-(-Z)-(V)M	Port A end Port B end	123 (4.84) -	- 123 (4.84)	- 182 (7.17)	182 (7.17) -	- -
DG4V-5-*A(L)/B(L)-H2-(V)M	Port A end Port B end	138 (5.43) -	- 138 (5.43)	- 223 (8.78)	223 (8.78) -	- -
DG4V-5-*A(L)/B(L)-P-(V)M	Port A end Port B end	123 (4.84) -	- 123 (4.84)	- 195 (7.68)	195 (7.68) -	- -
DG4V-5-*C/N(-Z)-(V)M	Both ends	123 (4.84)	123 (4.84)	-	-	246 (9.68)
DG4V-5-*C/N-H-(V)M	Both ends	138 (5.43)	138 (5.43)	-	-	276 (10.87)

DC Solenoid Models

3rd angle projection 

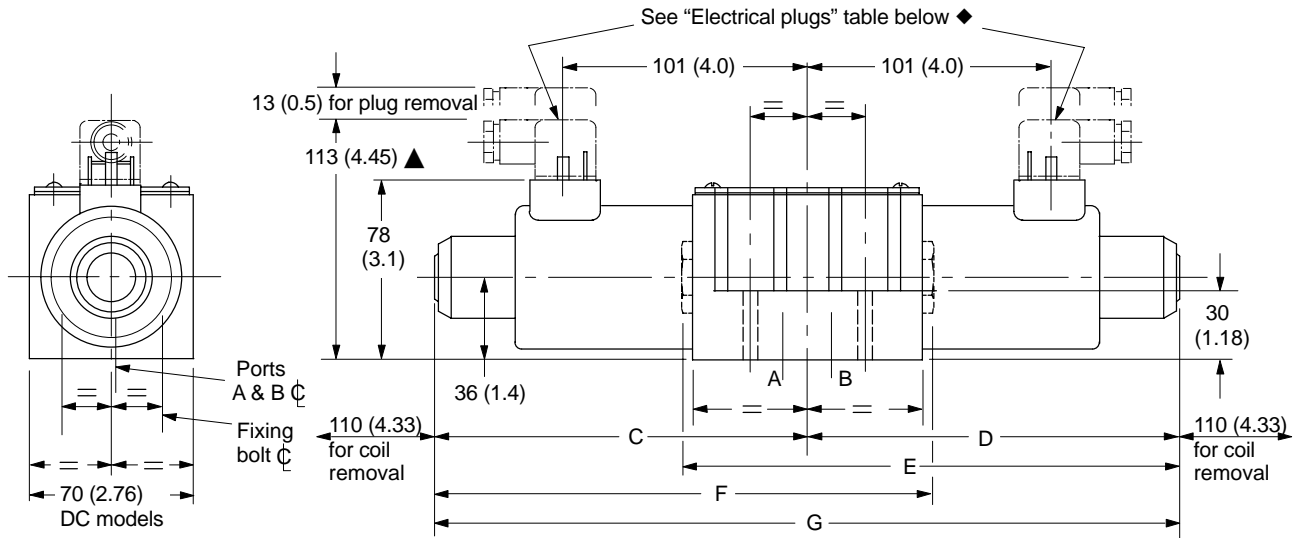

- ▲ May vary according to plug source.
- ◆ The cable entry can be repositioned at 90° intervals from the position shown. This is done by reassembling the contact holder into the appropriate position inside the plug housing.

Model	Solenoid at:	C	D	E	F	G
DG4V-5-*A(L)/B(L)-(-Z)-(V)M	Port A end Port B end	156 (6.14) -	- 156 (6.14)	- 215 (8.46)	215 (8.46) -	- -
DG4V-5-*A(L)/B(L)-H2-(V)M	Port A end Port B end	185 (7.28) -	- 185 (7.28)	- 270 (10.63)	270 (10.63) -	- -
DG4V-5-*A(L)/B(L)-P-(V)M	Port A end Port B end	156 (6.14) -	- 156 (6.14)	- 228 (8.98)	228 (8.98) -	- -
DG4V-5-*C/N(-Z)-(V)M	Both ends	156 (6.14)	156 (6.14)	-	-	312 (12.28)
DG4V-5-*C/N-H-(V)M	Both ends	185 (7.28)	185 (7.28)	-	-	370 (14.57)

Spool Position Indicator Switch Models

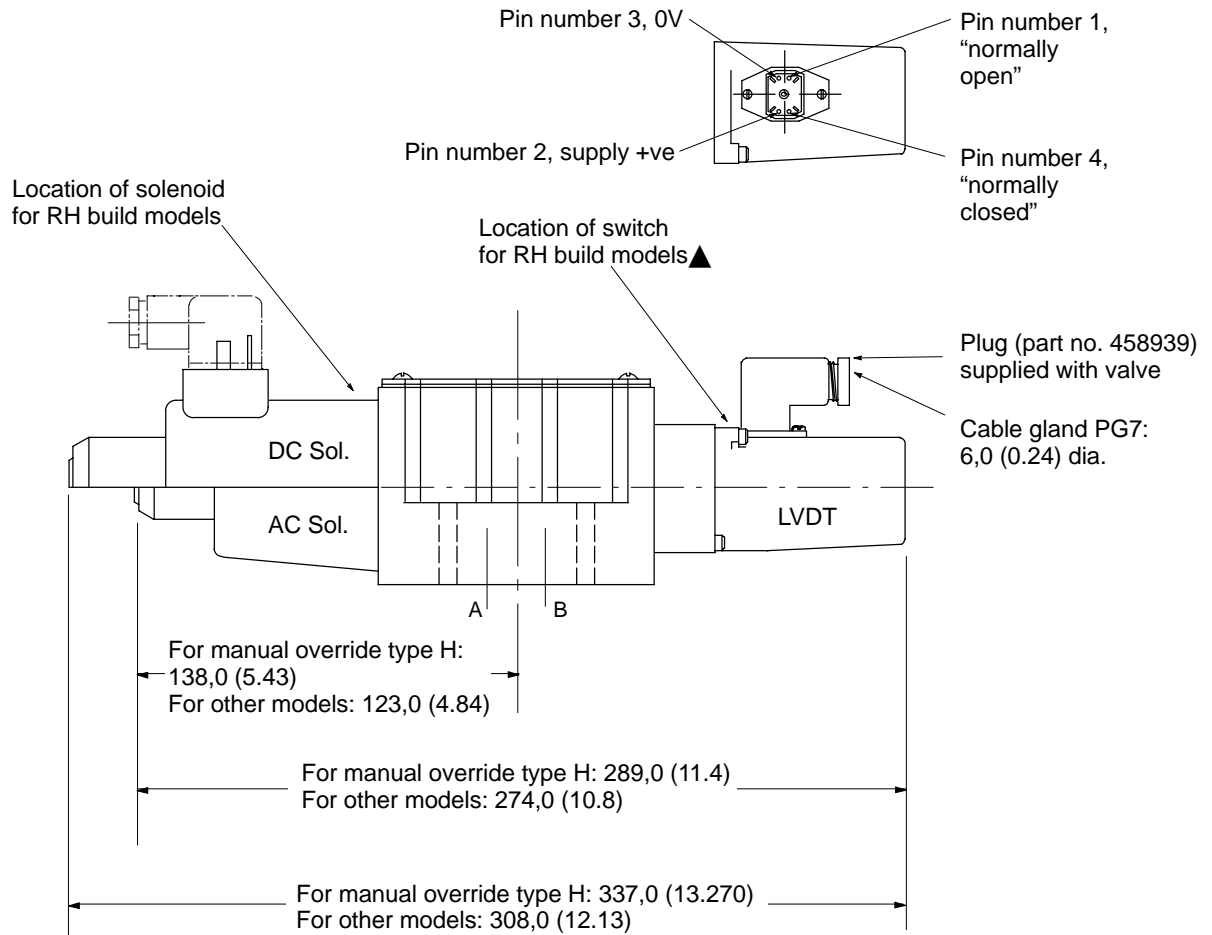
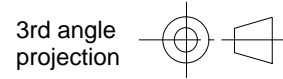

▲ For LH models ("L" in model code location 3) solenoid and switch locations are reversed

Wiring: See warning note on page A.5

Model (see also 5 in "Model Codes")	Spool types	Solenoid identity	
		Port A end	Port B end
DG4V-5-*A(J)/B(J)(-**-M	All except 8	B	–
DG4V-5-*A(J)/B(J)(-**-VM	All except 8	A	–
	8 only	–	B
DG4V-5-*AL(J)/BL(J)(-**-M	All except 8	–	A
DG4V-5-*AL(J)/BL(J)(-**-VM	All except 8	–	B
	8 only	A	–
DG4V-5-*C(J)/N(J)(-**-M	All except 8	B	A
DG4V-5-*C(J)/N(J)(-**-VM	All spools	A	B

Electrical plug(s) (without indicator light) to DIN 43650.

Must be ordered separately by part number(s).

Part No.	Color	Solenoid /LVDT identity	Cable gland
710775	Black	B	Pg11 Ø6-10 mm
710776	Gray	A	Pg11 Ø6-10 mm
458939	Gray	LVDT	Pg7 Ø3,5-6 mm

Spool Speed Control Orifice

For fine tuning of valve spool speed.

Only applicable to valves already fitted with an orifice or blank plug, see model code, page A.3.



Warning - Changing procedure

Before breaking a circuit connection make certain that power is off and system pressure has been released. Lower all vertical cylinders, discharge accumulators and block any load whose movement could generate pressure. Plug all removed units and cap all lines to prevent entry of dirt into the system.

Orifice Kit

Orifice kits must be ordered separately, part number 02-350116.

Kit comprises 1 off each of the following:

0,6 mm dia

0,8 mm dia

1,0 mm dia

1,2 mm dia

Blank

SystemStak™ Valves

ISO 4401 -05 size, 315 bar (4500 psi) and 120 l/min (32 USgpm) maximum ratings

Pressure relief and reducing, sequence, counterbalance, and flow control functions



Table of Contents

Introduction	1
DGMC-5 Single Relief DGMC2-5 Dual and Crossport Pilot Operated Relief Valves	3
DGMX2 Pressure Reducing/Relieving Valves	13
DGMR1 Sequence Valve	17
DGMR Counterbalance Valves	20
DGMFN Flow Control Valves	24
DGMPC Pilot Operated Check Valves	30
DGMDC Direct Check Valves	33
Knob Adjusters	37
Mounting Surface	38
DGM**-5	
DGM**-5N	
DGM**-5P	
Bolt Extender Kits	39
Subplates and Blanking Plate	40
Application Data	43
Fluid Cleanliness, Fluid Viscosity, Fluids and Seals	

Introduction

General Description

Vickers SystemStak™ valves make compact hydraulic systems in which modular valves are “sandwich” mounted between a directional valve and a standard mounting surface. Compact design improves system response by elimination of external fluid conductors, thereby resulting in elimination of resonant sounds which are noisy and lead to leakage. The design of these valves is well proven and offers opportunities for achieving small control assemblies, especially when the valves are used with multi-station manifolds.

Three mounting surfaces are available for interfacing with directional valves and are coded “5”, “5N”, or “5P” in the model numbers of Vickers SystemStak valves. The “5” interface accepts Vickers DG4S4 directional valves and other directional valves with a standard ISO 4401-05, NFPA-D05, ANSI/B93.7M size D05 or CETOP-5 port pattern. “5N” and “5P” NFPA-D05 interfaces accept

the Vickers directional valves listed on page 38.

Each valve “stak” can be configured to provide the specific combination of functions required to meet the system’s needs.

SystemStak valves are divided into two groups:

1. Valves acting in the pressure and/or tank lines (“P” and/or “T”)

DGMC	Relief valve
DGMDC	Direct check
DGMFN	Flow control
DGMR1	Sequence valve
DGMX2	Pressure reducing

The general rule for this group is that the DGMC relief valve be placed nearest the subplate or manifold.

The DGMDC direct check valve should be placed nearest the directional control valve.

The DGMR1 sequence valve should be the farthest valve from the directional valve. The DGMR1 must be mounted directly to a subplate or manifold with a drain port, to externally drain the DGMR1 at the mounting face.

2. Valves acting in the service lines (“A” and/or “B”)

DGMC	Relief valve
DGMC2	Dual relief valve
DGMDC	Direct check
DGMPC	Pilot operated check
DGMFN	Flow control
DGMR	Counterbalance

The general rule for this group is that the DGMC system relief valve be the farthest valve from the directional valve.

When using a DGMPC with a DGMFN (meter-out), the DGMPC should be nearest the directional valve.

Features and Benefits

● Reduced space requirements

Stackable SystemStak valves, used with ISO 4401-05, CETOP 5 (NFPA-D05) directional controls, provide compact cost-effective control of actuator direction, speed and force.

● Reduced installed cost

SystemStak valves eliminate all intervalve piping and connections, thereby reducing the number of potential leakage points. Installed cost is less than when using conventional subplate- or line-mounted valves.

● Versatile & easy to install

SystemStak valves have all the internal passages necessary to serve the directional valve mounted above them. Any directional valve with a standard ISO 4401-05, NFPA-D05, ANSI/B93.7M size D05 or CETOP-5 port pattern can be used with ISO 4401-05 SystemStak valves.

Vickers bolt-extender kits simplify valve installation by permitting each valve body to be separately and quickly installed, and correctly torqued down. The kits also allow the directional valve to be removed for service or replacement without disturbing the stack.

● Rugged & reliable

Internal working parts are produced from hardened steel, and reside in a continuous-cast ductile (spheroidal graphite) iron body. Excellent reliability is ensured, even in high pressure applications. Working parts are serviceable without removing valves from the stack.

Easy to Understand, Easy to Design

SystemStak circuitry is best shown using slightly different symbols than those for traditional valve configurations. Each SystemStak symbol has the same basic form and size as shown in Figure 1.

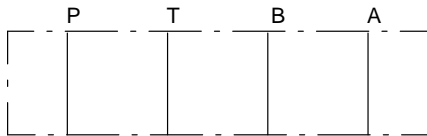

Figure 1.

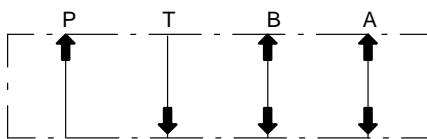

Figure 2.

For ease of understanding, remember the directions of flow for each line, and that all four flow paths pass through each valve (see Figure 2). For clarity, directional valves are drawn vertically in SystemStak circuit diagrams (see Figure 3.)

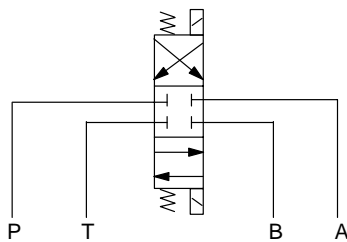

Figure 3.

Each station (valve stack) is a combination of functions. When designing and assembling SystemStak valves, care must be taken to ensure that they interact as required by stacking the functions in the correct sequence (see Figure 4). Direct check valves should be placed closest to the directional valve. Relief valves should normally be positioned next to the mounting surface (i.e. at the bottom of the stack). When both a flow control and a pilot operated check valve is required, it is recommended that the flow control valve be between the check valve and the actuator to prevent check valve chatter.

A combination of directional valve, SystemStak valve(s) and subplate/manifold block (Figure 5 single station subplate and Figure 6 multi station manifold) completes the assembly.

Figure 7 represents a complete SystemStak system, showing typical use of functions available from this range. The circuit diagram also shows the use of a tapping plate for accessing line pressure readings, and a blanking plate to close off an unused station of a multi-station manifold.

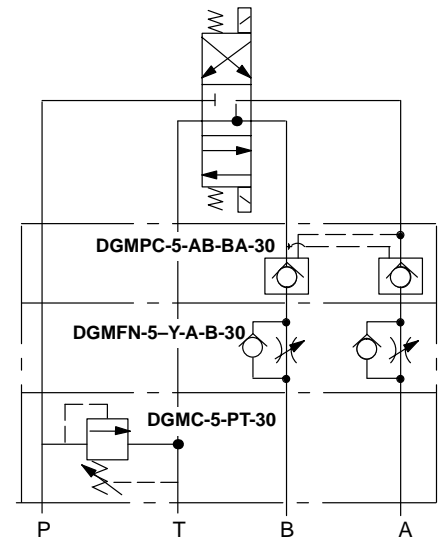

Figure 4.

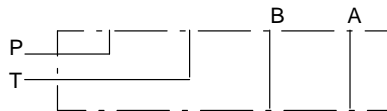

Figure 5.

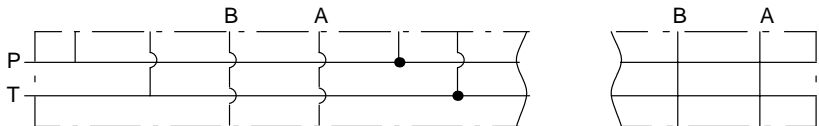

Figure 6.

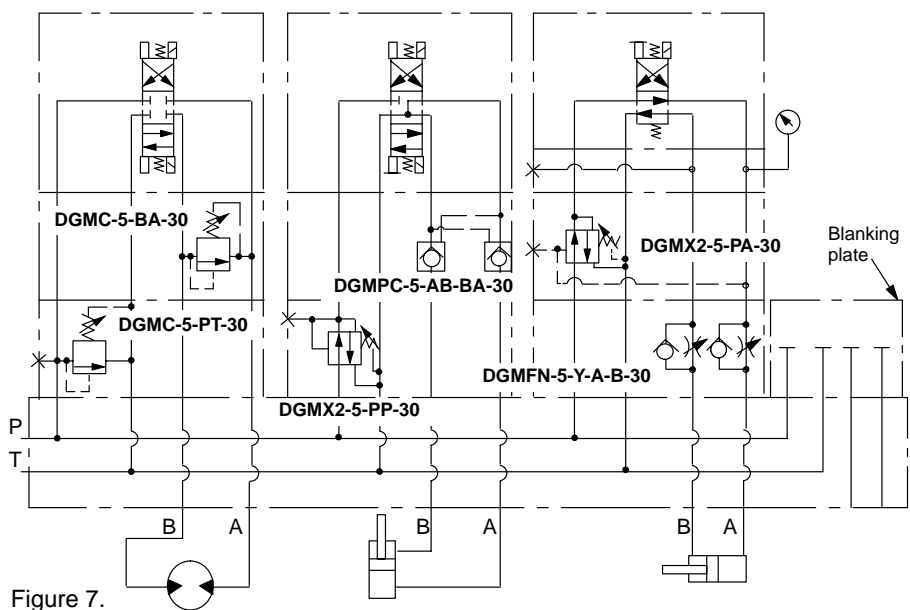

Figure 7.

DGMC/DGMC2 Pilot Operated Relief Valves

General Description

These two-stage valves limit system pressure by directing flow to tank or the opposite cylinder port (A-B/B-A crossport types) when system pressure reaches the valve setting.

Pressure control may be obtained in "A", "B", "A" and "B", or "P" port, and pilot flow may be internally or externally drained, depending on model type.

Any pressure in the line to which these valves are drained is additive to the valve pressure setting.

The valve pressure setting is adjustable by means of either an adjusting screw and locknut, a hand-knob adjuster, or a micrometer knob with keylock.

External remote control/vent connections are available on all models except crossport relief. If required on crossport models, contact your Vickers representative.

Model Code

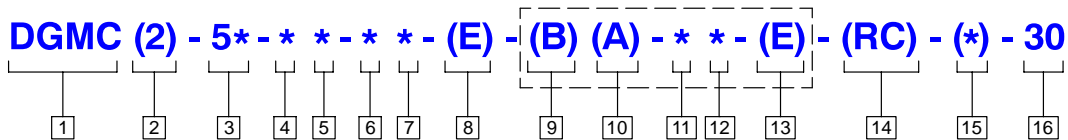

1 Valve function

Manifold or subplate mounted pressure relief valve.

2 Valve type

2 - Dual relief cavities
Blank - Single relief

3 Interface

5 - ISO 4401-AC-05-4-A, CETOP RP35H ANSI/NFPA D05
5N - NFPA D05 (Alt. A)
5P - NFPA D05 (Alt. B)

4 Port operated upon

A - "A" cylinder port (single, dual or crossport types)
B - "B" cylinder port (single type only)
P - Pressure port (single type only)

5 Port drained into

A - "A" cylinder port
B - "B" cylinder port (crossport type only)
T - Tank port (single or dual types)

6 Pressure range

A - 4 to 50 bar (60 to 725 psi)
B - 4 to 100 bar (60 to 1450 psi)
F - 4 to 200 bar (60 to 2900 psi)
G - 4 to 315 bar (60 to 4500 psi)

7 Adjustment device

H - Knob adjuster
K - Micrometer knob with keylock
W - Screw with locknut

8 External drain

E - External drain
Omit for internal drain models.

9 P port acted upon

B - "B" cylinder port (dual or crossport type)
Omit for single type.

10 Port drained into

A - "A" cylinder port (crossport type only)
T - Tank port (dual type only)

11 Pressure range

Omit for single type.
A - 4 to 50 bar (60 to 725 psi)
B - 4 to 100 bar (60 to 1450 psi)
F - 4 to 200 bar (60 to 2900 psi)
G - 4 to 315 bar (60 to 4500 psi)

12 Adjustment device

Omit for single relief models.
H - Knob adjuster
K - Micrometer knob with keylock
W - Screw with locknut

13 External drain

E - External drain same as position 8
Omit for single relief models.

14 Remote control port

RC - Remote control port
Not available on crossport models.

15 Gage port & thread type

Gage port for P-T models only; optional remote control (RC) and external drain (E) ports as applicable. Omit for crossport models
B - G 1/8" (1/8" BSPF)
S - SAE-4 O-ring boss port (0.4375-20 UNF-2B thread)

16 Design number - 30 series

Subject to change. Installation dimensions unaltered for design numbers 30 to 39 inclusive.

Functional Symbols

DGMC2-5-AT-**-BT-**-30

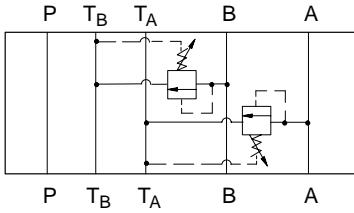

DGMC-5-AT-**-30

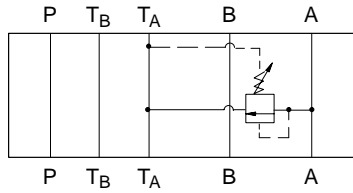

DGMC-5-BT-**-E-**-30

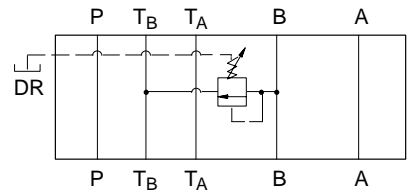

DGMC2-5-AT-**-BT-**-RC-**-30

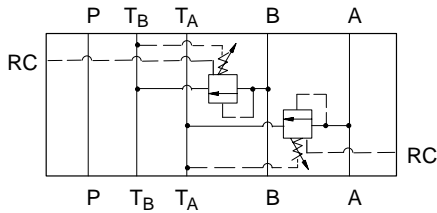

DGMC-5-AT-**-RC-**-30

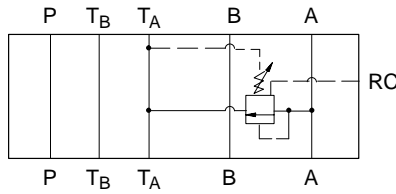

DGMC-5-BT-**-E-**-RC-**-30

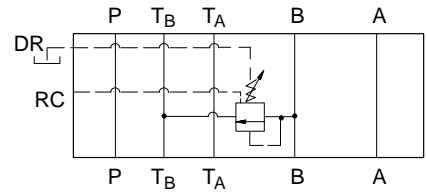

DGMC2-5-AT-**-E-BT-**-E-**-30

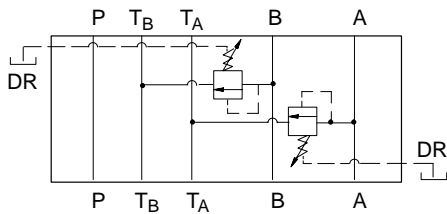

DGMC-5-AT-**-E-**-30

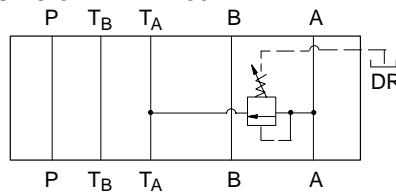

DGMC-5-PT-**-30

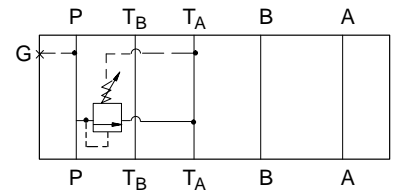

DGMC2-5-AT-**-E-BT-**-E-**-RC-**-30

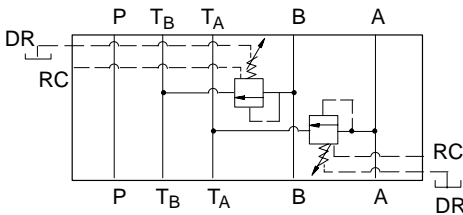

DGMC-5-AT-**-E-**-RC-**-30

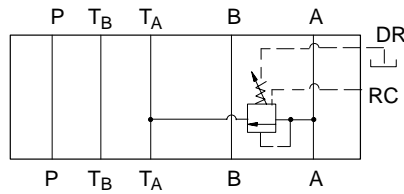

DGMC-5-PT-**-RC-**-30

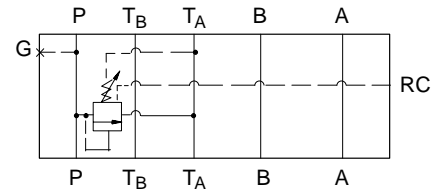

DGMC2-5-AB-**-BA-**-30

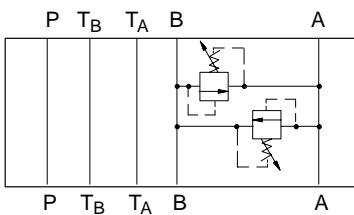

DGMC-5-BT-**-30

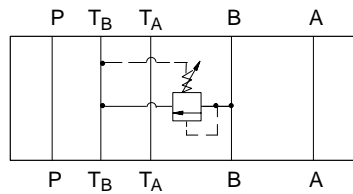

DGMC-5-PT-**-E-**-30

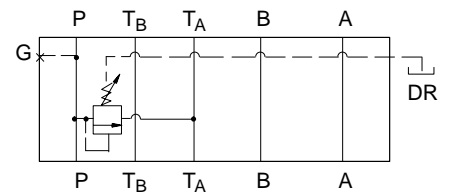

DGMC2-5-AB-**-E-BA-**-E-**-30

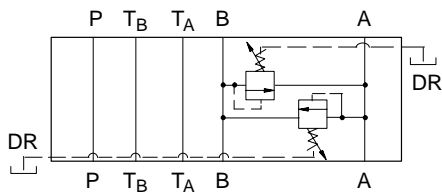

DGMC-5-BT-**-RC-**-30

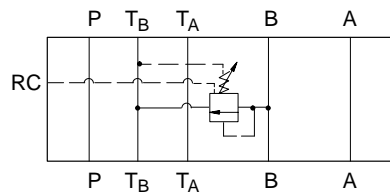

DGMC-5-PT-**-E-**-RC-**-30

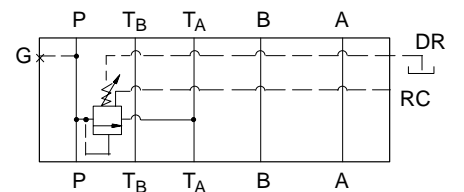

DGMC2-5N-AT-**-BT-**-30

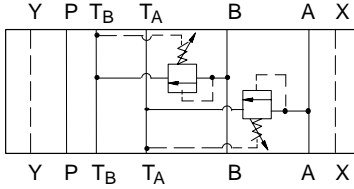

DGMC-5N-AT-**-30

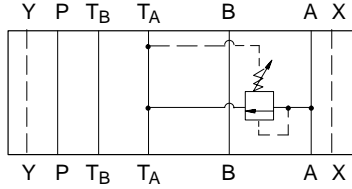

DGMC-5N-BT-**-E-RC-**-30

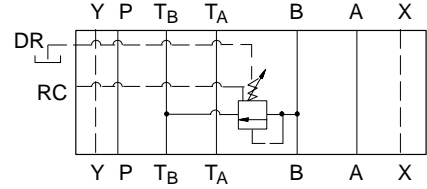

DGMC2-5N-AT-**-BT-**-RC-**-30

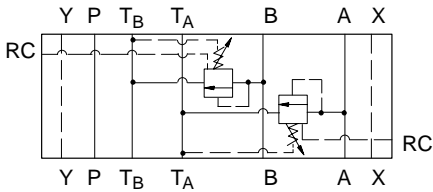

DGMC-5N-AT-**-RC-**-30

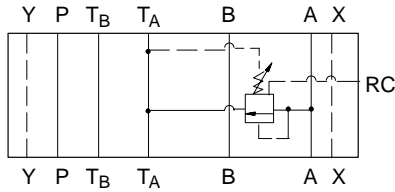

DGMC-5N-BT-**-E-**-30

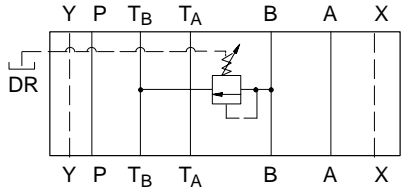

DGMC2-5N-AT-**-E-BT-**-E-**-30

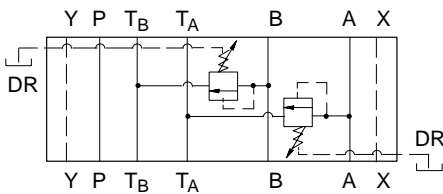

DGMC-5N-AT-**-E-**-30

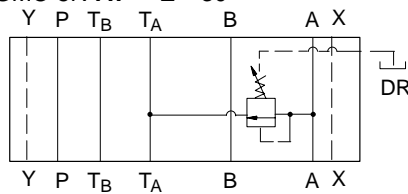

DGMC-5N-PT-**-30

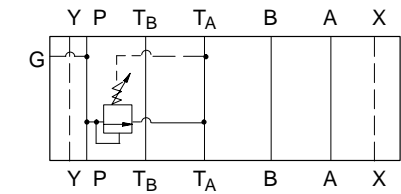

DGMC2-5N-AT-**-E-BT-**-E-RC-**-30

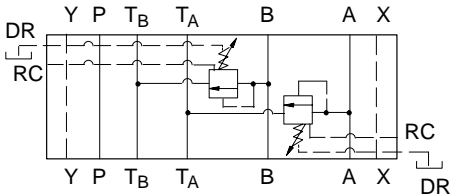

DGMC-5N-AT-**-E-RC-**-30

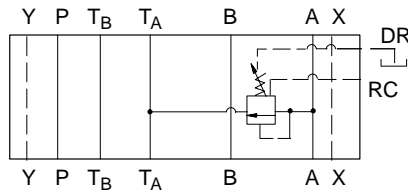

DGMC-5N-PT-**-RC-**-30

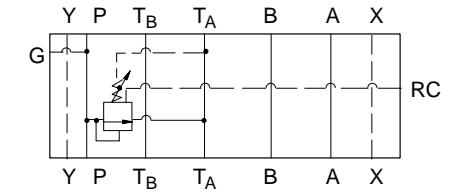

DGMC2-5N-AB-**-BA-**-30

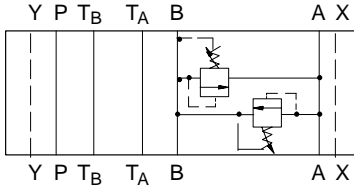

DGMC-5N-BT-**-30

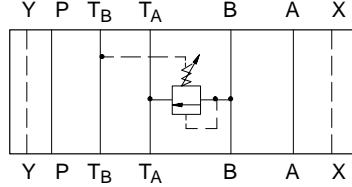

DGMC-5N-PT-**-E-**-30

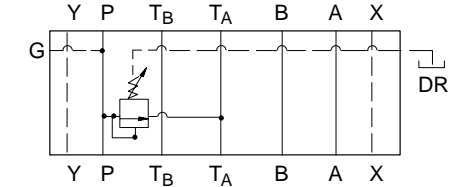

DGMC-5N-BT-**-RC-**-30

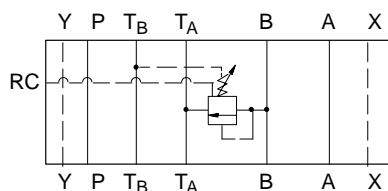

DGMC-5N-PT-**-E-RC-**-30

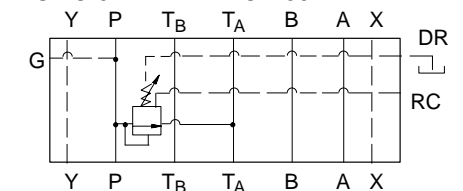

DGMC2-5P-AT-**-BT-**-30

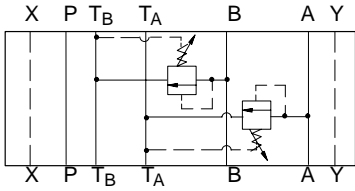

DGMC-5P-AT-**-30

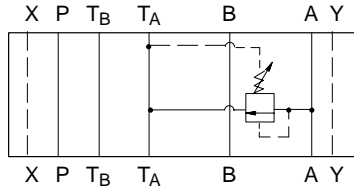

DGMC-5P-BT-**-E-RC-**-30

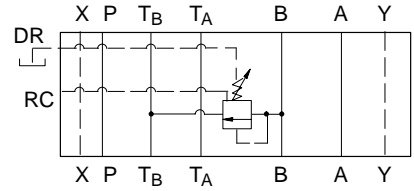

DGMC2-5P-AT-**-BT-**-RC-**-30

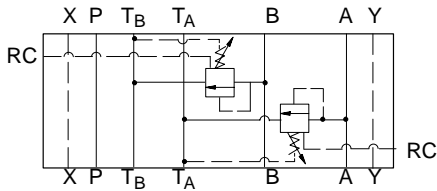

DGMC-5P-AT-**-RC-**-30

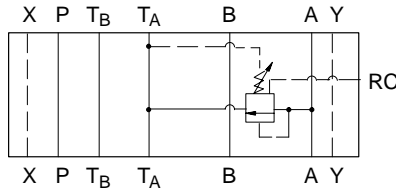

DGMC-5P-BT-**-E-**-30

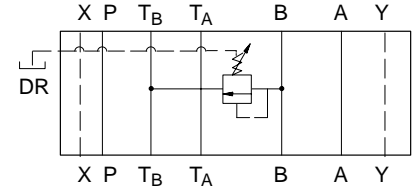

DGMC2-5P-AT-**-E-BT-**-E-**-30

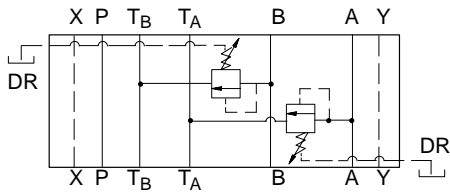

DGMC-5P-AT-**-E-**-30

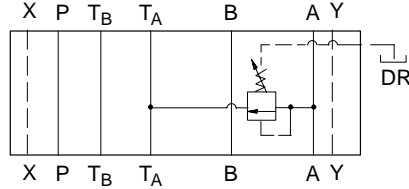

DGMC-5P-PT-**-30

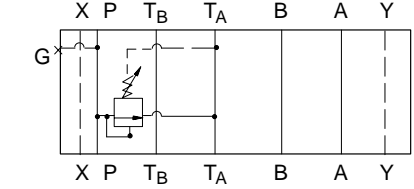

DGMC2-5P-AT-**-E-BT-**-E-RC-**-30

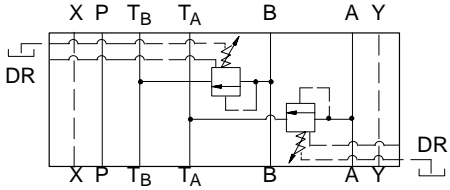

DGMC-5P-AT-**-E-RC-**-30

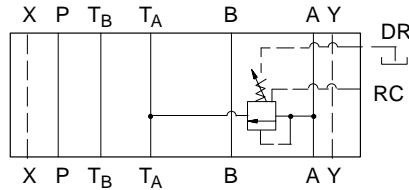

DGMC-5P-PT-**-RC-**-30

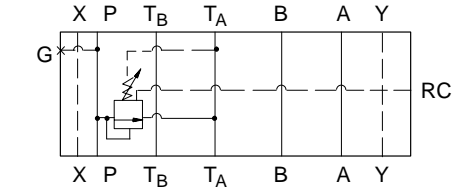

DGMC2-5P-AB-**-BA-**-30

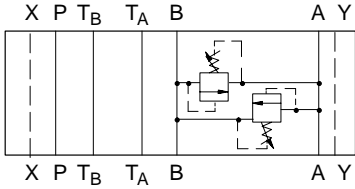

DGMC-5P-BT-**-30

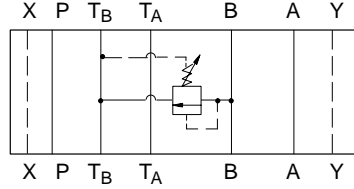

DGMC-5P-PT-**-E-**-30

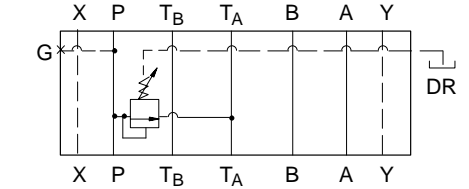

DGMC-5P-BT-**-RC-**-30

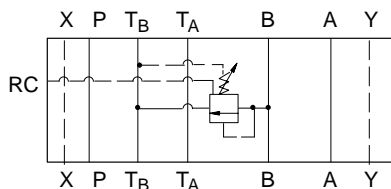

DGMC-5P-PT-**-E-RC-**-30

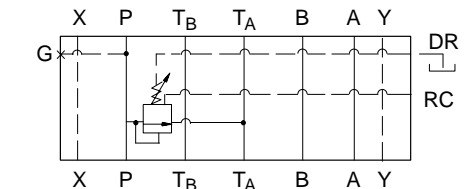

Operating Data

Basic Characteristics

Maximum flow: 120 l/min (32 USgpm)
 Pilot flow: @ 50° C (120° F) and 315 bar (4500 psi) 400–700 ml/min (24 in³/min-43 in³/min)
 Maximum operating pressure: 315 bar (4500 psi)
 Response time: For conditions of 5 liters (300 in³) of oil under compression and a flow rate of 120 l/min (32 USgpm) typical response is: .

Initial pressure	Final pressure	Response time
17 bar (250 psi)	35 bar (500 psi)	95 ms
35 bar (500 psi)	140 bar (2000 psi)	110 ms
35 bar (500 psi)	315 bar (4500 psi)	150 ms

Pressure overshoot: 31 bar (450 psi)
 Operating temperature: -0° to 80° C (32° to 180° F)
 Weights: DGMC 2,9 kg (6.5 lbs)
 DGMC2 3,6 kg (7.9 lbs)

DGMC-5 and DGMC2-5 Insertion Loss

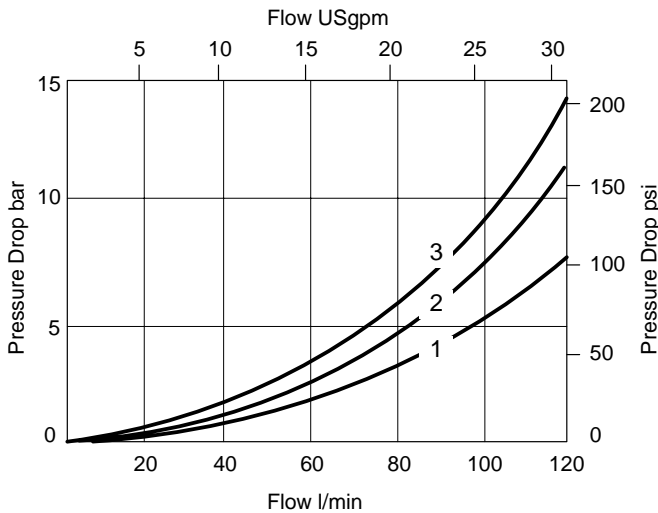

Insertion Loss

Total change in pressure drop from through ports “P” “B”, “A” and “T” caused by the addition of the SystemStak valve to a hydraulic circuit. Insertion loss curves (see top left):

1. DGMC2-5-AT-**-*(E)-BT-**-*(E)-(RC)*-30
 DGMC-5-AT-**-*(E)-(RC)*-30
 DGMC-5-BT-**-*(E)(RC)*-30
2. DGMC-5-PT-**-*(E)-(RC)*-30
3. DGMC2-5-AB-**-BA-**-30

DGMC-5 and DGMC2-5 Pressure Override

The pressure override chart (below) shows typical override of different adjustment ranges at maximum settings.

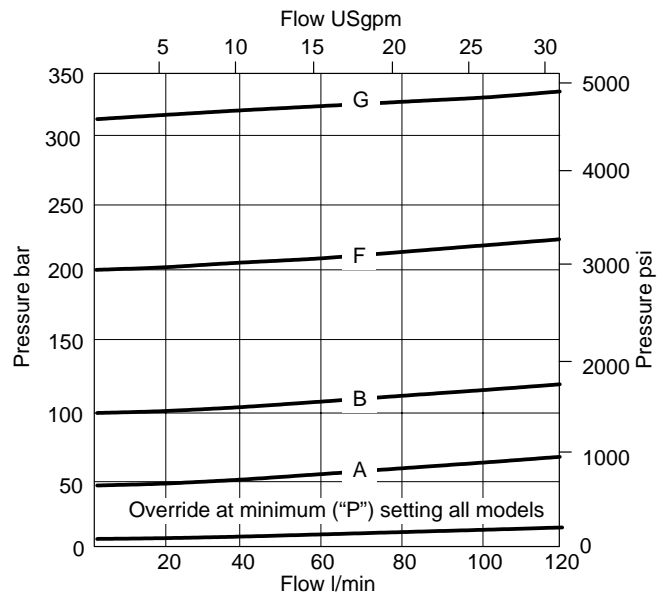

DGMC-5 and DGMC2-5 Vented Pressure (RC models only)

(Not applicable for crossport models)

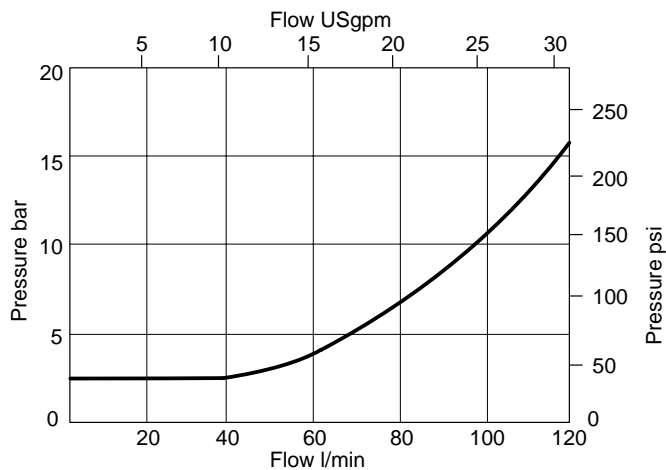

The vented pressure chart (above) indicates flow from control port to discharge port over relief element.

Installation Dimensions

DGMC-5-PT Single Relief

mm (inches)

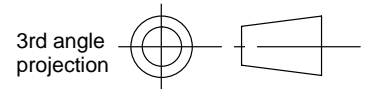

See page 37 for optional adjustment devices.
See page 38 for interface dimensions.

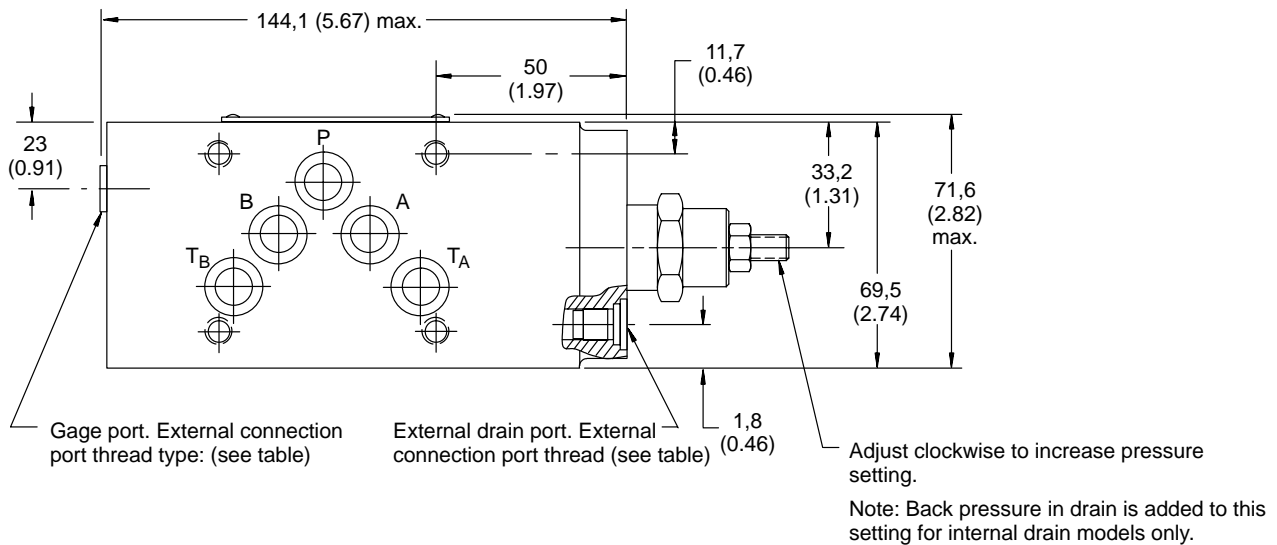
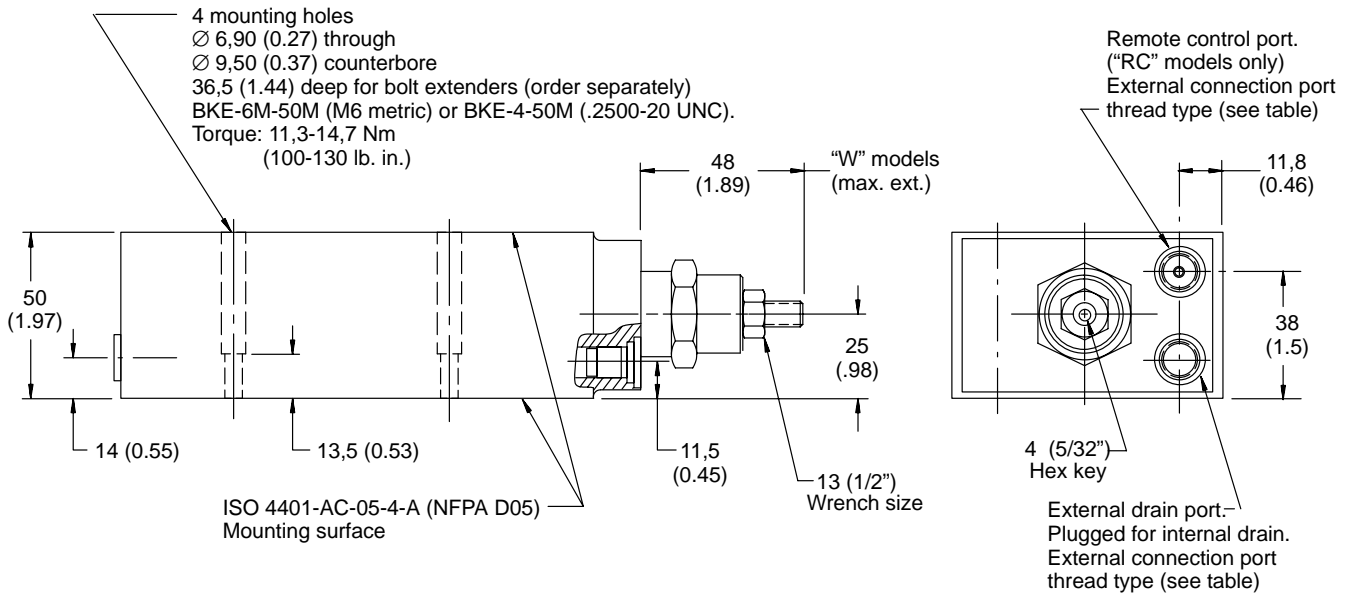

External connection port threads

"S" models - SAE-4 O-ring boss port
 (0.4375-20 UNF-2B thread).

"B" models - G 1/8 (1/8 BSPF)

DGMC-5-BT Single Relief

mm (inches)

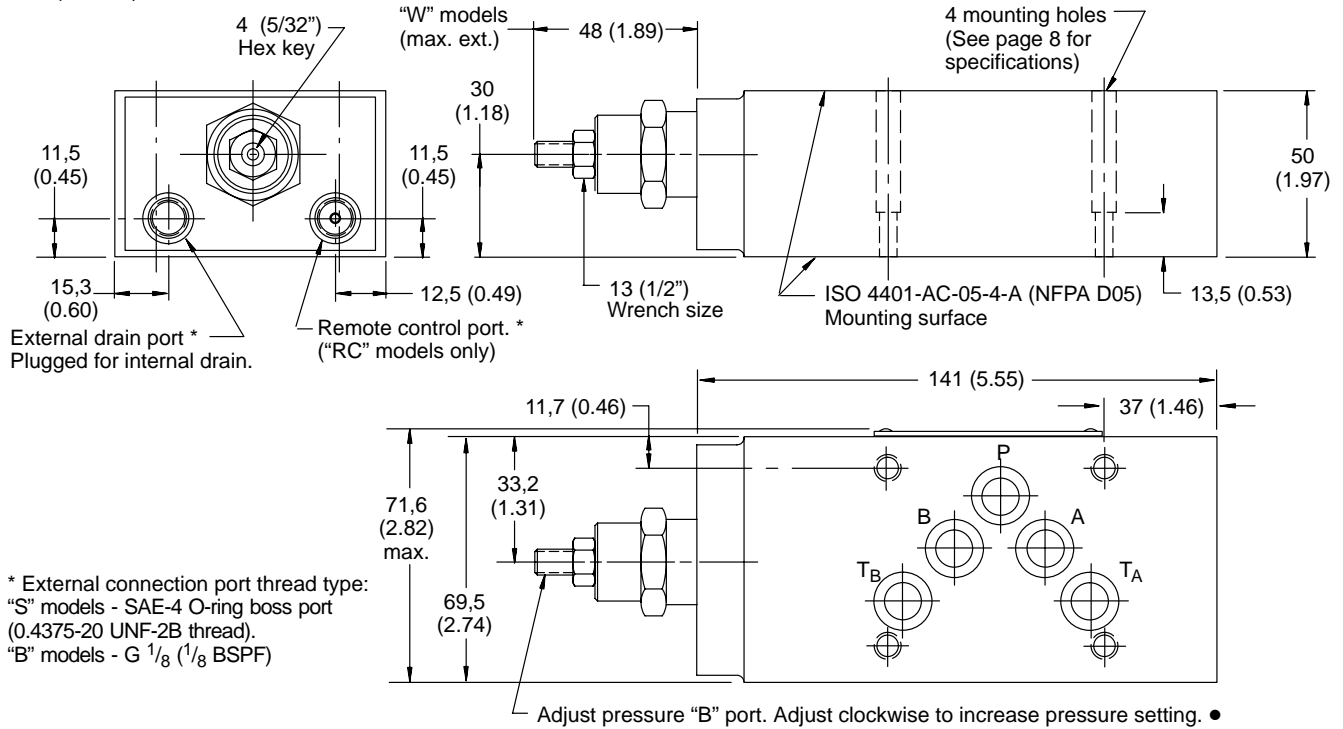

* External connection port thread type:
 "S" models - SAE-4 O-ring boss port
 (0.4375-20 UNF-2B thread).
 "B" models - G 1/8 (1/8 BSPF)

See page 37 for optional adjustment devices.

See page 38 for interface dimensions.

● Back pressure in drain is added to this setting for internal drain models only.

DGMC-5-AT Single Relief

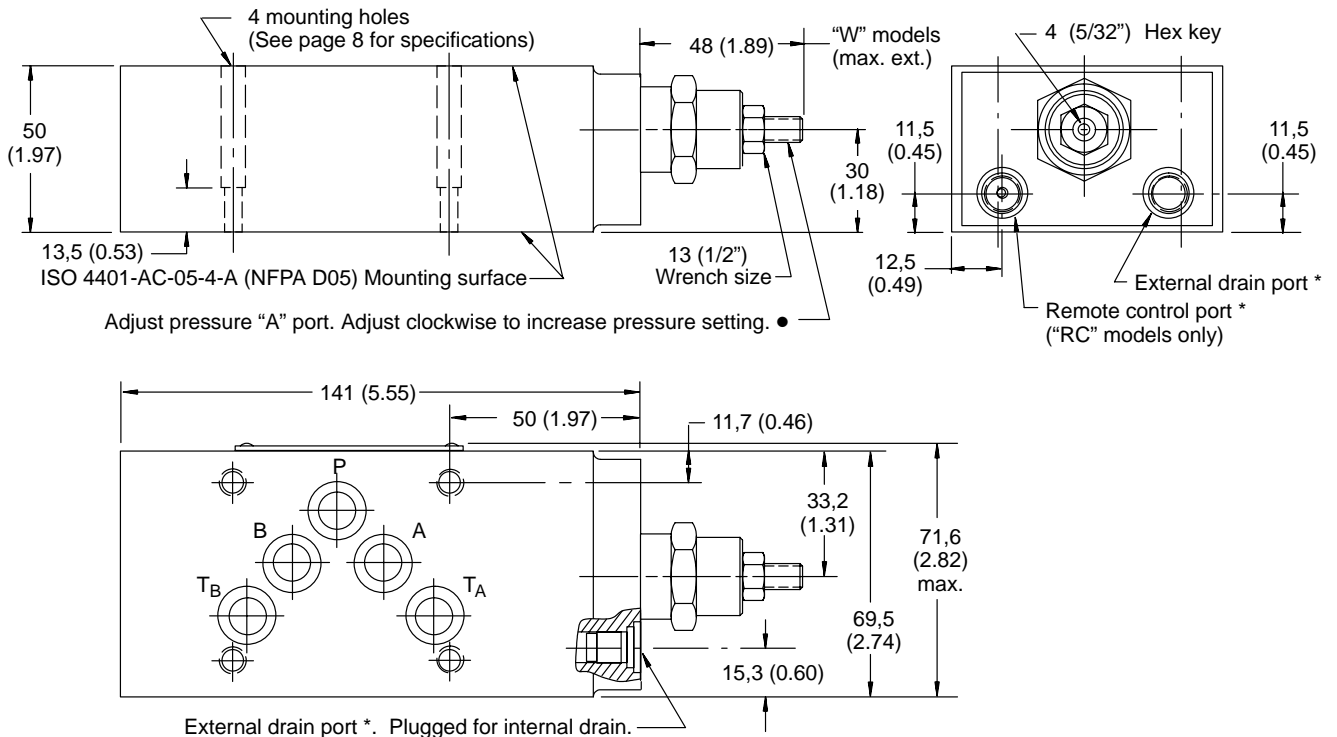

DGMC2-5-AT-**-BT-**-30

Dual Relief

mm (inches)

See page 37 for optional adjustment devices.

See page 38 for interface dimensions.

4 mounting holes
 Ø 6,9 (0.27) through
 Ø 9,50 (0.37) counterbore
 36,5 (1.44) deep
 for bolt extenders
 (order separately)
 BKE-6M-50M (M6 metric) or
 BKE-4-50M (.2500-20 UNC).
 Torque: 11,3-14,7 Nm
 (100-130 lb. in.)

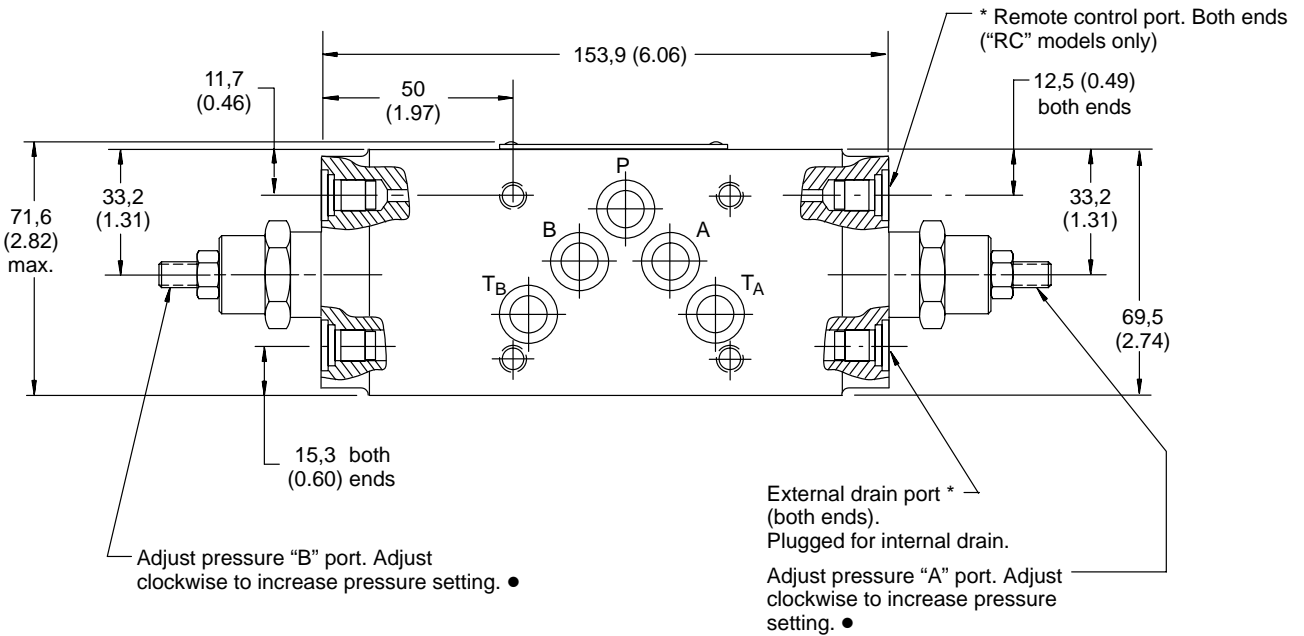
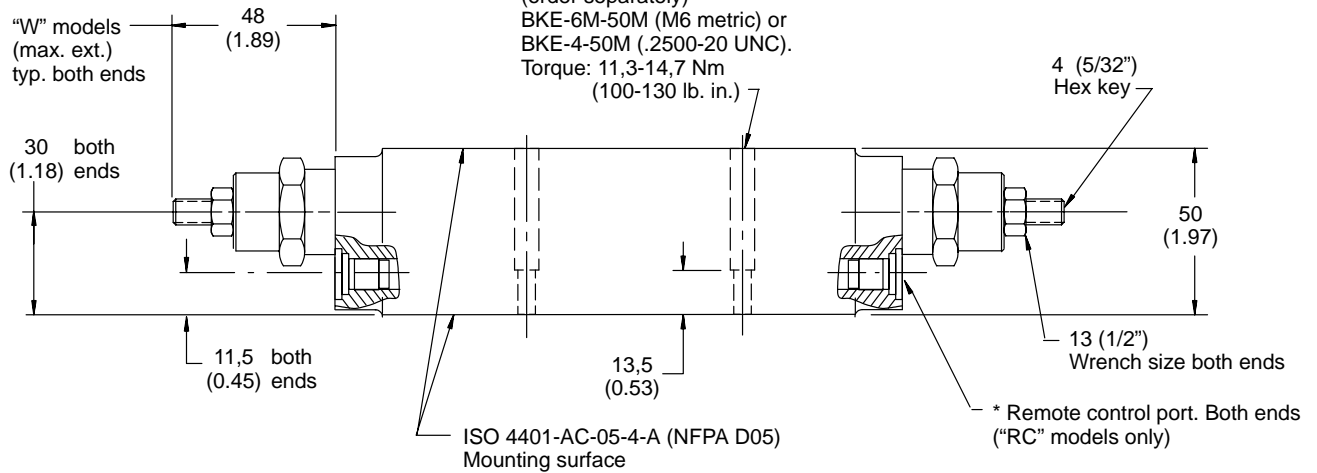

* External connection port thread type:
 "S" models - SAE-4 O-ring boss port
 (0.4375-20 UNF-2B thread).
 "B" models - G 1/8 (1/8 BSPF)
 [15] in model code

● Back pressure in drain is added to this setting for internal drain models only.

DGMC2-5-AB-**-BA-**-30

Dual Crossport Relief

mm (inches)

See page 37 for optional adjustment devices.
See page 38 for interface dimensions.

4 mounting holes
 \varnothing 6,90 (0.27) through.
 \varnothing 9,50 (0.37) counterbore
 46,5 (1.83) deep
 for bolt extenders
 (order separately)
 BKE-6M-60M (M6 metric) or
 BKE-4-60M (.2500-20 UNC).
 Torque: 11,3-14,7 Nm
 (100-130 lb. in.)

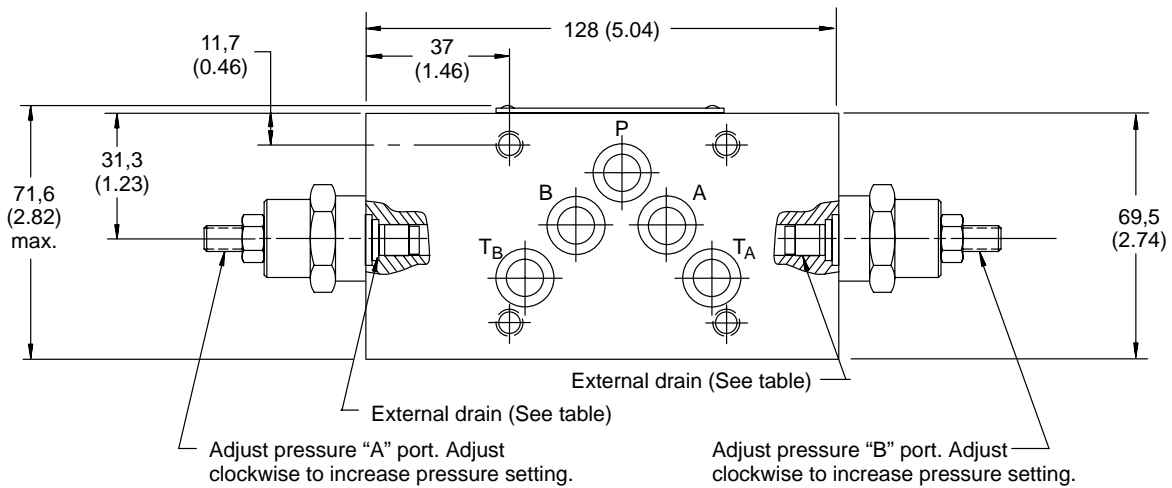
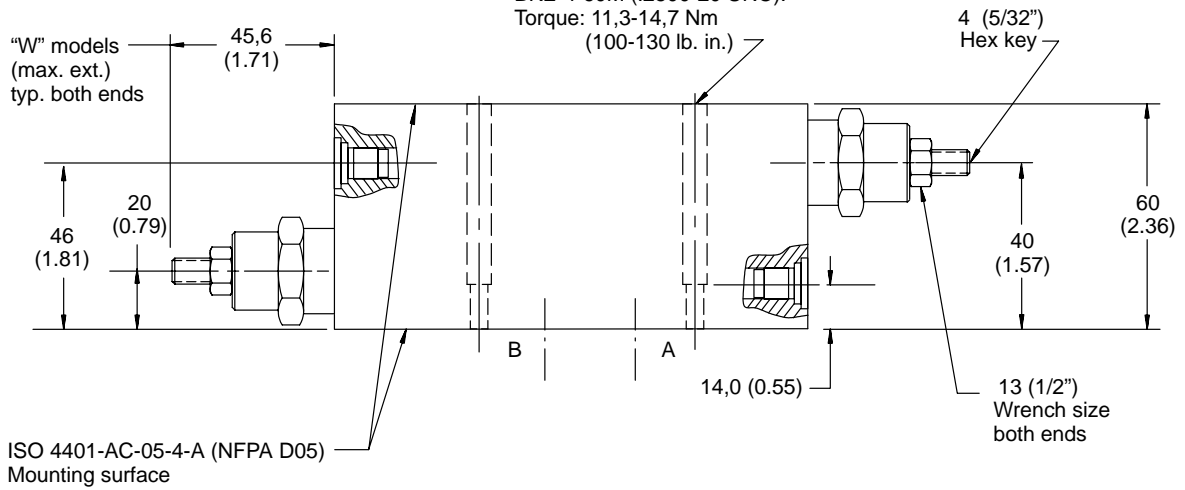

External drain port threads

"S" models - SAE-4 O-ring boss port
 (0.4375-20 UNF-2B thread).

"B" models - G 1/8 (1/8 BSPF)

DGMC-5-AB--*(E)-*-30**
Single Crossport Relief

mm (inches)

See page 37 for optional adjustment devices.
 See page 38 for interface dimensions.

4 mounting holes
 Ø 6,90 (0.27) through.
 Ø 9,50 (0.37) counterbore
 46,5 (1.83) deep
 for bolt extenders
 (order separately)
 BKE-6M-60M (M6 metric) or
 BKE-4-60M (.2500-20 UNC).
 Torque: 11,3-14,7 Nm
 (100-130 lb. in.)

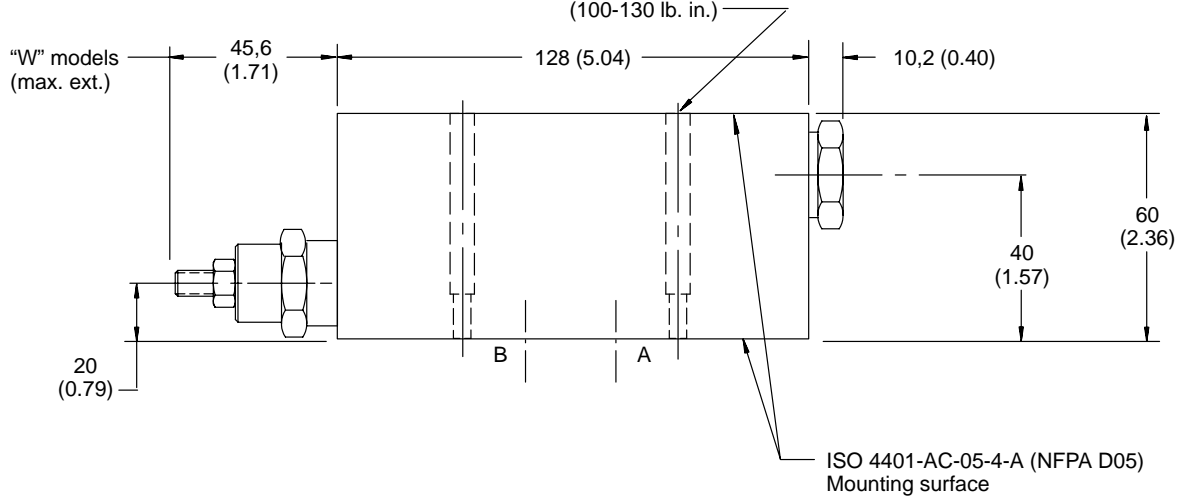

DGMC-5-BA--*(E)-*-30**
Single Crossport Relief

mm (inches)

4 mounting holes
 (See above for specifications)

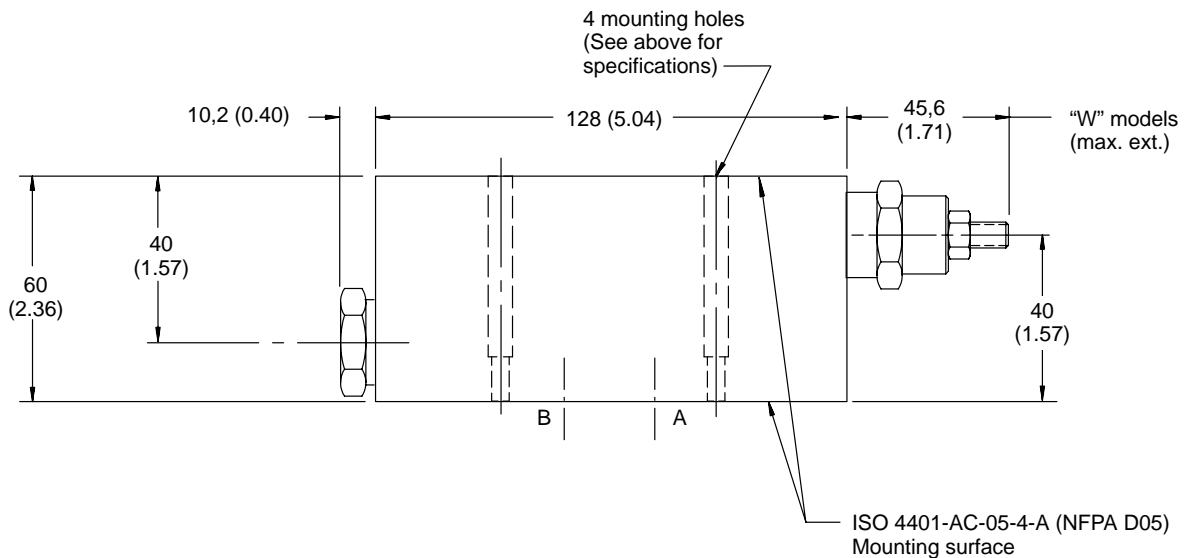

[Click here for optional adjustment devices.](#)

[Click here for interface dimensions.](#)

DGMX2 Pressure Reducing/Relieving Valves

General Description

These two-stage spool valves maintain a reduced outlet pressure against variations in inlet pressure.

These valves are able to act as relief valves (at 50% of maximum flow) to prevent excess pressure being developed when an actuator is subject to a reactive load. Relief flow is directed to the "T_B" port. *Therefore, for the relief function to operate, all components above this DGMX2 module must contain the "T_B" port, and the directional valve must have the "T_B" bypass feature.*

Pilot control may be from the "P", "A", or "B" port. Pilot drain flow may be directed

internally to tank port "T_A", or externally out of the valve body.

Any pressure in the line to which these valves are drained is additive to the valve pressure setting.

The valve pressure setting is adjustable by means of either an adjusting screw containing an internal hex, a hand-adjust knob, or a micrometer knob with keylock.

Different spring ratings cover an overall pressure range from 2 to 315 bar (30-4500 psi).

The metering spool element in this design is always positioned in the "P"

line (see symbols on page14). The connection of the pilot control line determines at which port the reduced pressure is obtained. For example:

- "PP" pilot for reduced pressure in "P" port
- "PA" pilot for reduced pressure in "A" port
- "PB" pilot for reduced pressure in "B" port

The "A" and "B" line models provide for reduced pressure when "P" is connected to "A" or "B". It allows free flow through the service port when connected to "T" (all via a four-way directional valve).

Model Code

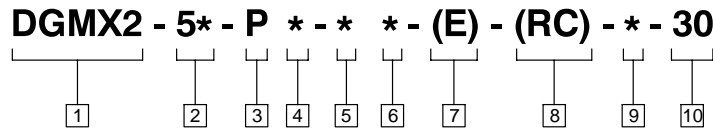

1 Valve function

Manifold or subplate mounted reducing/relieving valve.

2 Interface

5 - ISO 4401-AC-05-4-A, CETOP 5
RP35A size 5 ANSI/NFPA D05
5N - NFPA D05 (Alt. A)
5P - NFPA D05 (Alt. B)

3 Port operated upon

P - Pressure port

4 Pilot control

A - Cylinder port A
B - Cylinder port B
P - Pressure port

5 Pressure range

A - 2,0 to 50 bar (30 to 725 psi)
B - 8,5 to 100 bar (125 to 1450 psi)
F - 8,5 to 200 bar (125 to 2900 psi)
G - 8,5 to 315 bar (125 to 4500 psi)

6 Adjustment device

H - Knob adjuster
K - Micrometer knob with keylock
W - Screw with locknut

7 External drain

E - External drain
Omit for internal drain models.

8 Remote control

Omit if not required.

9 Gage port & thread type

Gage port (all models),
external drain (E)
B - G 1/8" (1/8" BSPF)
S - SAE-4 O-ring boss port
(0.4375-20 UNF-2B thread)

10 Design number - 30 series

Subject to change. Installation dimensions unaltered for design numbers 30 to 39 inclusive.

Operating Data

Basic Characteristics

Maximum flow: 120 l/min (32 USgpm)
 Pilot flow rate @ 50° C (120° F) and 315 bar (4500 psi): 290 - 420 ml/min (18-26 in³/min)
 Leakage flow rate @ 50° C (120° F) and 315 bar (4500 psi): . . . 80-200 ml/min (15-12 in³/min)
 (Leakage to "Tb" around spool land
 @315 bar (4500 psi) reduced pressure)
 Maximum operating pressure: "A" models - 70 bar (1000 psi) * (inlet pressure) 50 bar (725 psi)
 (reduced pressure)
 "B", "F" & "G" models - 315 bar (4500 psi)
 Weight: 3,5 kg (7.7 lbs)

* Slightly higher pressure override characteristics between 70 bar (1000 psi) and 315 bar (4500 psi) inlet.

DGMX2 Insertion Losses

These curves show the typical pressure drop for each flow path in the valve. The "P" port pressure drop is the pressure drop for flow across the reducing valve spool in the fully open condition. The total insertion loss for the valve must be calculated by summing the losses through each of the four flow paths.

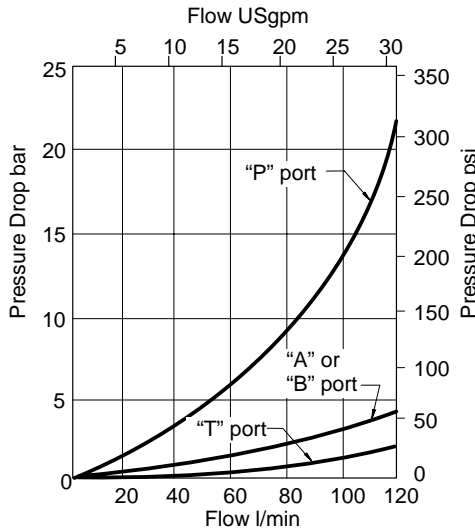

DGMX2 Pressure Override

These curves show the typical roll off or underide of the different pressure ranges at maximum settings. Also shown is the typical override of the relieving feature which prevents undesirable pressure rise in the reduced pressure port.

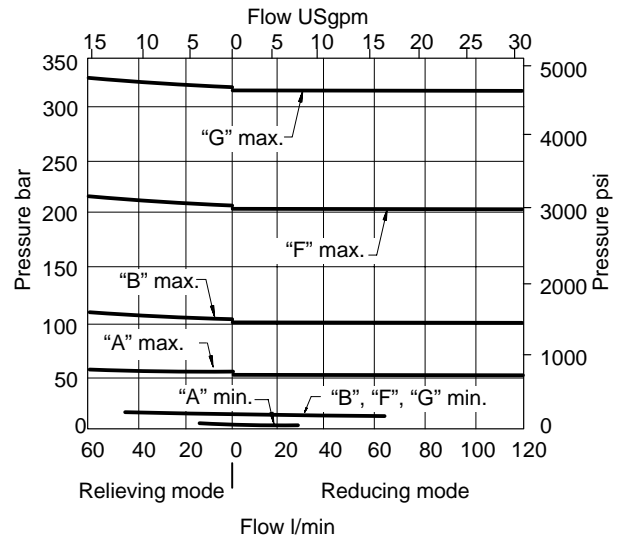

DGMX2 Minimum Reduced Pressure

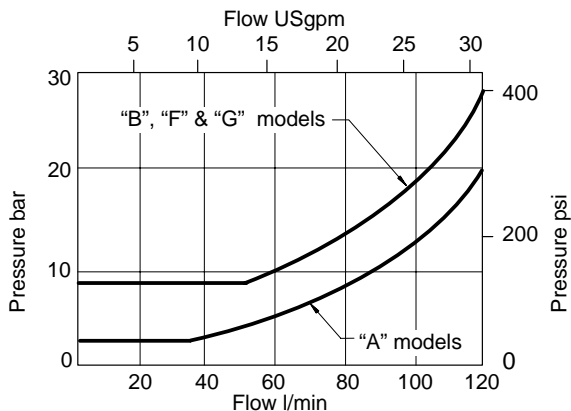

The curves (left) show the minimum reduced pressure settings allowable for a given flow rate. The minimum pressure setting applies regardless of inlet pressure. Operation of the valve below minimum settings may cause erratic valve operation due to insufficient spring force to counter flow forces acting on the spool.

Installation Dimensions

DGMX2-5-PA/PB/PP Reducing/Relieving Valves

mm (inches)

See page 37 for optional adjustment devices.
See page 38 for interface dimensions.

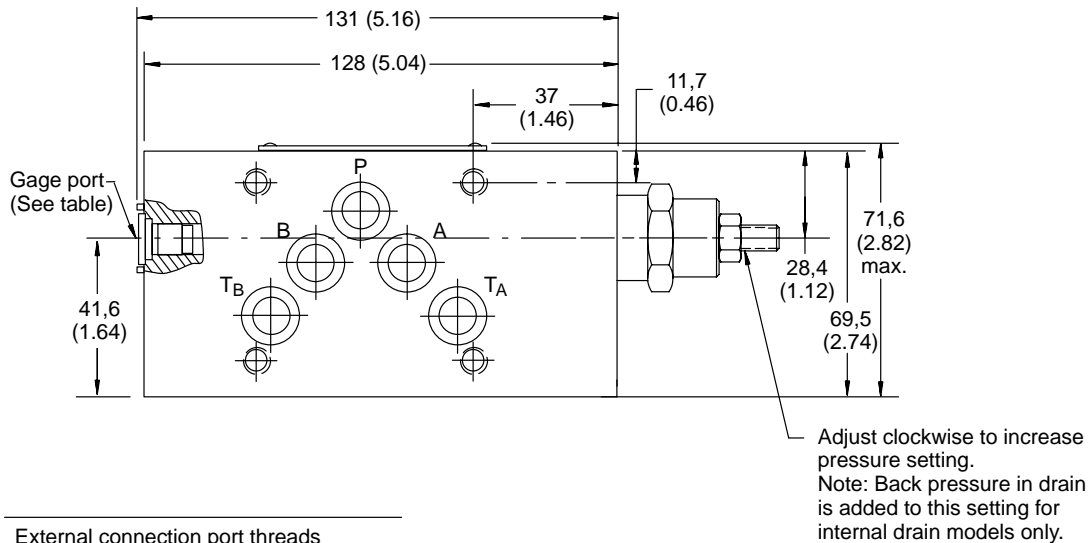
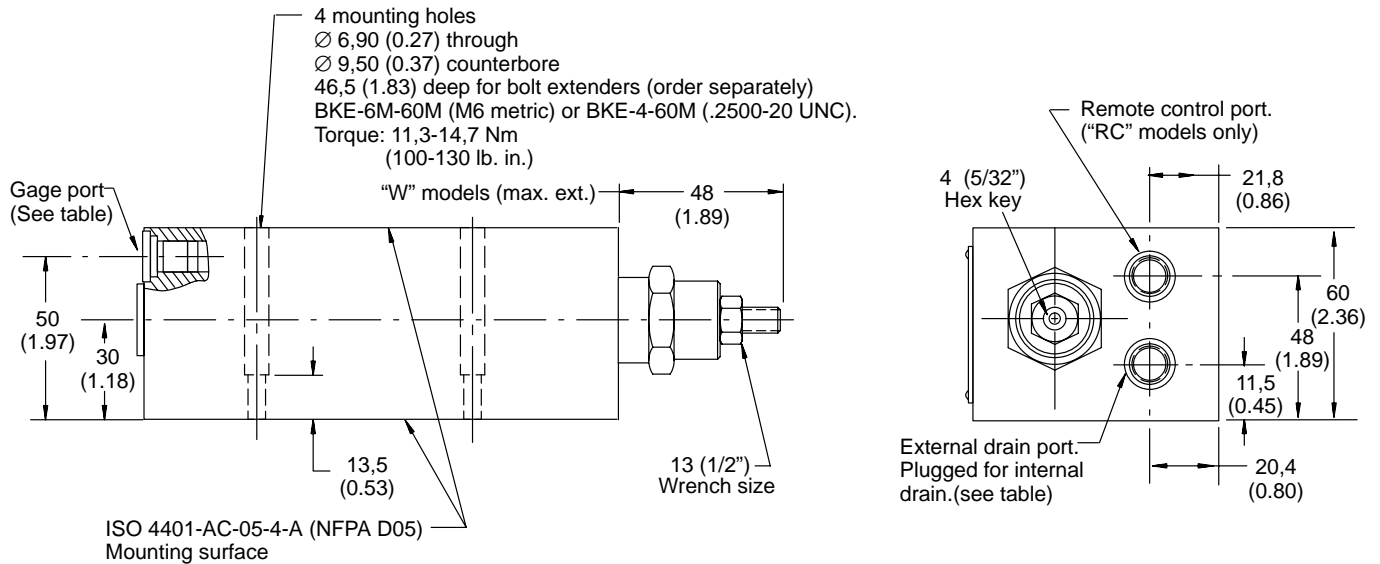
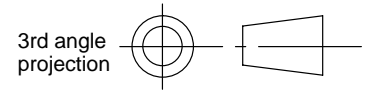

External connection port threads

"S" models - SAE-4 O-ring boss port
(0.4375-20 UNF-2B thread).

"B" models - G 1/8 (1/8 BSPF)

DGMR1 Internal Pilot Operated Sequence Valves

General Description

These two-stage pressure operated valves are normally closed to flow through the main spool flow path. When system pressure reaches or exceeds the valve setting, the main spool flow path opens. Pilot flow may be externally or internally drained to tank.

Any pressure in the line to which these valves are drained is additive to the valve pressure setting.

The valve pressure setting is adjustable by means of either an adjustable screw

containing an internal hex, a hand-adjust knob, or a micrometer knob with keylock. Different spring ratings cover an overall pressure range from 5 to 315 bar (75-4500 psi).

Model Code

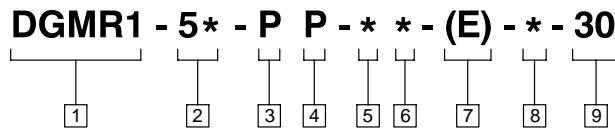

1 Valve function

Manifold or subplate mounted sequence valve.

2 Interface

5 - ISO 4401-AC-05-4-A, CETOP RP35H Size 5 ANSI/NFPA D05
 5N - NFPA-D05 (Alt A)
 5P - NFPA-D05 (Alt B)

3 Port operated upon

P - Pressure port

4 Pilot control

P - Pressure port

5 Pressure range

A - 5 to 50 bar (75 to 725 psi)
 B - 5 to 100 bar (75 to 1450 psi)
 F - 5 to 200 bar (75 to 2900 psi)
 G - 5 to 315 bar (75 to 4500 psi)

6 Adjustment device

H - Knob adjuster
 K - Micrometer knob with keylock
 W - Screw with locknut

7 External drain

E - External drain
 Omit for internal drain models.

8 Gage port & thread type

Gage port (all models), external drain (E) (optional).
 B - G 1/8" (1/8" BSPF)
 S - SAE-4 O-ring boss port (0.4375-20 UNF-2B thread)

9 Design number - 30 series

Subject to change. Installation dimensions unaltered for design numbers 30 to 39 inclusive.

Functional Symbols

DGMR1-5-PP-**-*-30

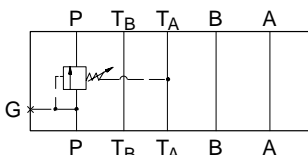

DGMR1-5-PP-**-E-**-30

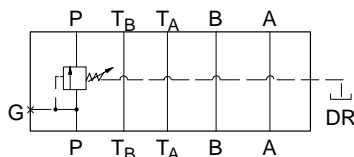

DGMR1-5N-PP-**-*-30

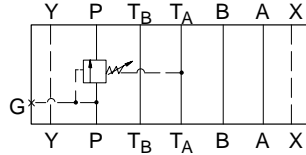

DGMR1-5N-PP-**-E-**-30

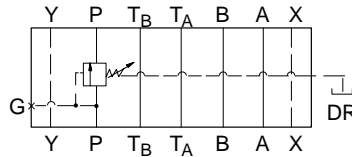

DGMR1-5P-PP-**-*-30

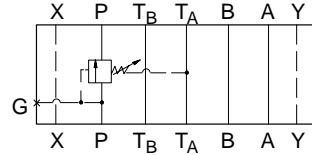

DGMR1-5P-PP-**-E-**-30

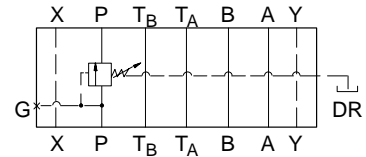

Operating Data

Basic Characteristics

Maximum flow:	120 l/min (32 USgpm)
Pilot flow @ 50° C (120° F) and 315 bar (4500 psi):	400-500 ml/min (24-31 in ³ /min)
Leakage flow rate @ 50° C (120° F) and 315 bar (4500 psi):	80-200 ml/min (5-12 in ³ /min)
Maximum operating pressure:	315 bar (4500 psi)
Operating temperature:	-0° to 80° C (32° to 180° F)
Weight:	3,5 kg (7.7 lbs.)

Insertion Losses

These curves show the typical pressure drop for each flow path in the valve. The "P" port pressure drop is the pressure drop for flow across the sequence valve spool in the fully open position.

The total insertion loss for the valve must be calculated by summing the losses through each of the four flow paths.

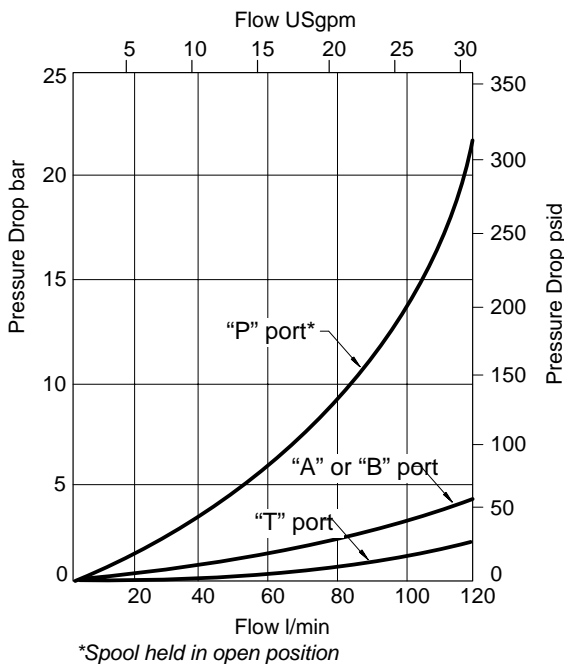

Pressure Override

Typical pressure override of the different pressure ranges at minimum and maximum settings.

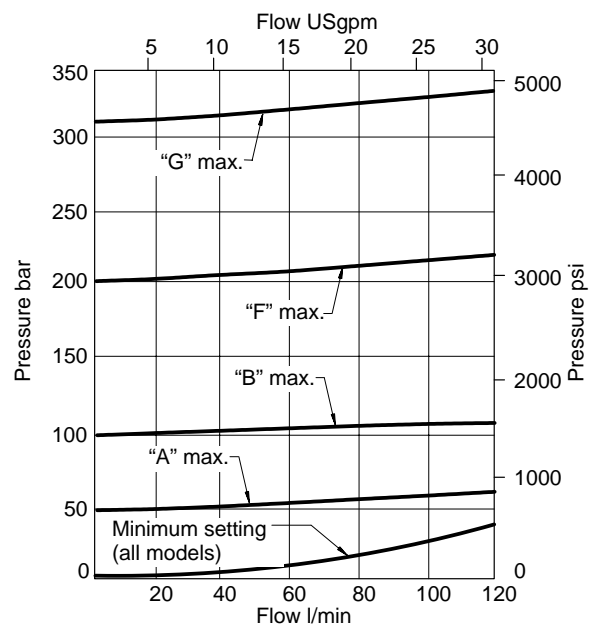

Installation Dimensions

DGMR1-5-PP-**-30

Sequence Valve

mm (inches)



See page 37 for optional adjustment devices.
See page 38 for interface dimensions.

4 mounting holes
 \varnothing 6,9 (0.27) through
 \varnothing 9,50 (0.37) counterbore
 46,5 (1.83) deep
 for bolt extenders
 (order separately)
 BKE-6M-60M (M6 metric) or
 BKE-4-60M (.2500-20 UNC).
 Torque: 11,3-14,7 Nm
 (100-130 lb. in.)

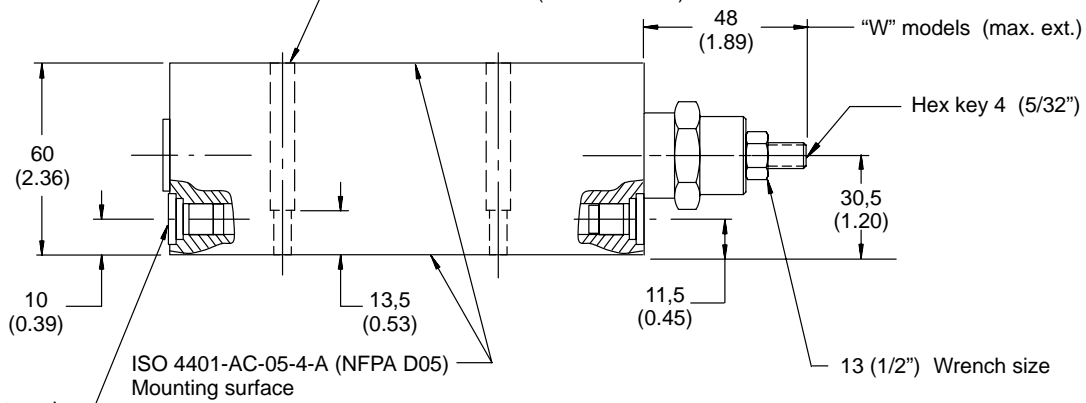

* Gage port. External connection port thread

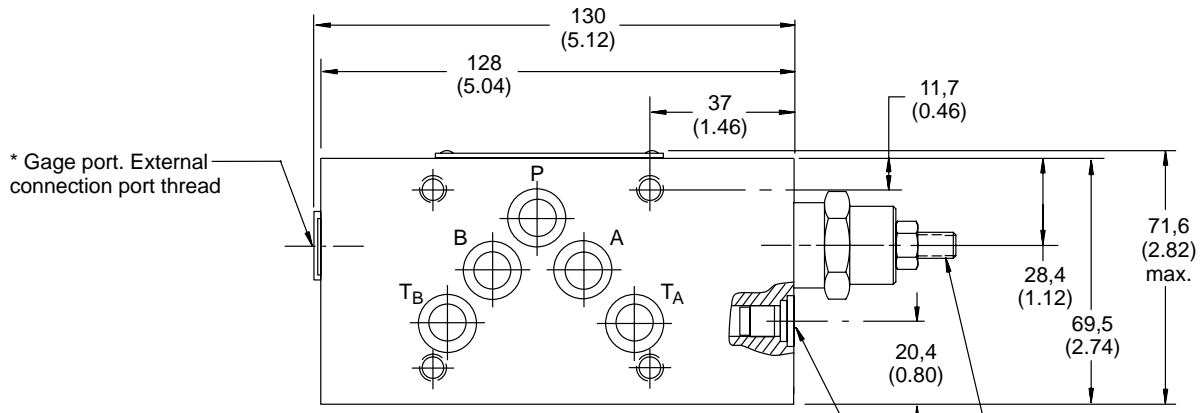

Adjust clockwise to increase pressure setting.
 Note: Back pressure in drain is added to this setting for internal drain models only.

- *External drain and gage port threads
- "S" models - SAE-4 O-ring boss port (0.4375-20 UNF-2B thread).
- "B" models - G 1/8 (1/8 BSPF)

DGMR Counterbalance Valves

General Description

Vickers SystemStak counterbalance valves provide continuous protection from pump cavitation and prevent an actuator from running ahead of the pump supply.

These valves also provide thermal relief protection in closed systems.

NOTE

Counterbalance valves adjust in the opposite direction of other pressure control valves. Turning the adjuster counterclockwise increases the valve setting. Turning the adjustment clockwise lowers the pressure setting, releasing the load.

Drain

Any pressure in the line to which these valves are drained is additive to the valve pressure setting.

Pilot pressure Calculation

To open the counterbalance valve by remote control (referring to functional symbols below):

$$\text{For 4:1 ratio (typically for cylinder load control), nominal pilot pressure at Port B =} \\ \frac{\text{Cracking pressure} + (5 \times \text{Port A}_1 \text{ pressure}) - \text{Port A pressure}}{4}$$

$$\text{For 10:1 ratio (typically for hydraulic motor control), nominal pilot pressure at Port B =} \\ \frac{\text{Cracking pressure} + (11 \times \text{Port A}_1 \text{ pressure}) - \text{Port A pressure}}{10}$$

Functional Symbols

DGMR-5-A*-FW-B*-FW-30

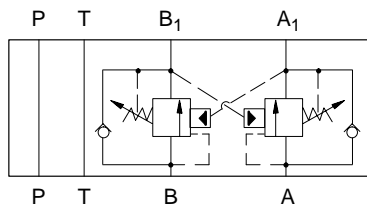

DGMR-5-A*-FW-30

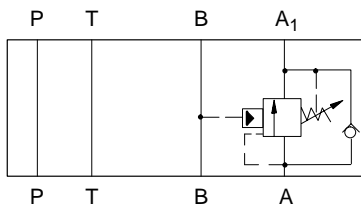

DGMR-5-B*-FW-30

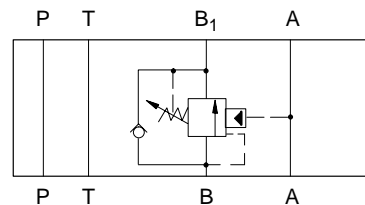

Model Code

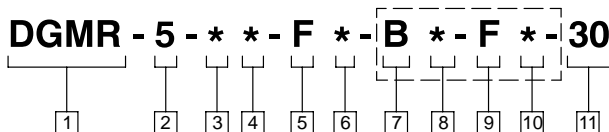

1 Valve function

Manifold or subplate mounted counterbalance valve.

2 Interface

5 - ISO 4401-AC-05-4-A, CETOP 5
RP35H, Size 5 ANSI/NFPA D05

3 Port operated upon

A - Counterbalance in A, piloted from B
B - Counterbalance in B, piloted from A

4 Pilot ratio

1 - 4:1
2 - 10:1

5 Pressure range

F - 60 to 210 bar (900 to 3000 psi)

6 Adjustment device

H - Knob adjuster
C - Cap over screw
W - Screw with locknut

7 Port acted upon

(Omit for single type.)
B - Counterbalance in B, piloted from A

8 Pilot ratio

(Omit for single type.)
1 - 4:1
2 - 10:1

9 Pressure range

(Omit for single type.)

F - 60 to 210 bar (900 to 3000 psi)

10 Adjustment device

(Omit for single type.)

H - Knob adjuster
C - Cap over screw
W - Screw with locknut

11 Design number - 30 series

Subject to change. Installation dimensions unaltered for design numbers 30 to 39 inclusive.

Operating Data

Basic Characteristics

Maximum operating pressure:	315 bar (4500 psi)
Maximum flow rate:	120 l/min (32 USgpm)
Load holding leakage @70% of pressure setting	0.35 ml/min.
Cracking Pressure Adjustment Range:	60-210 bar (900-3000 psi)
Pilot Ratios:	4:1, 10:1
Leakage:	5 drops/min, Port A to Port A ₁ at 70% of crack setting.
Temperature Range:	-40° to 80° C (-40° to 180° F)
Weight:	4,5 kg (10 lbs)

DGMR Performance Curves

Insertion Losses

These curves show the typical pressure drop for each flow path in the valve for fluid viscosity range 21-32 cSt (100-150 SSU).

The total insertion loss for the valve is calculated by summing the losses through each of the four flow paths.

- 1 "P" port for all models.
"A" port of DGMR-5-B*-30
"B" port of DGMR-5-A*-30
- 2 "T" port for all models.
- 3 Free flow through service port of counterbalance.
- 4 Piloted port open through service port of counterbalance.

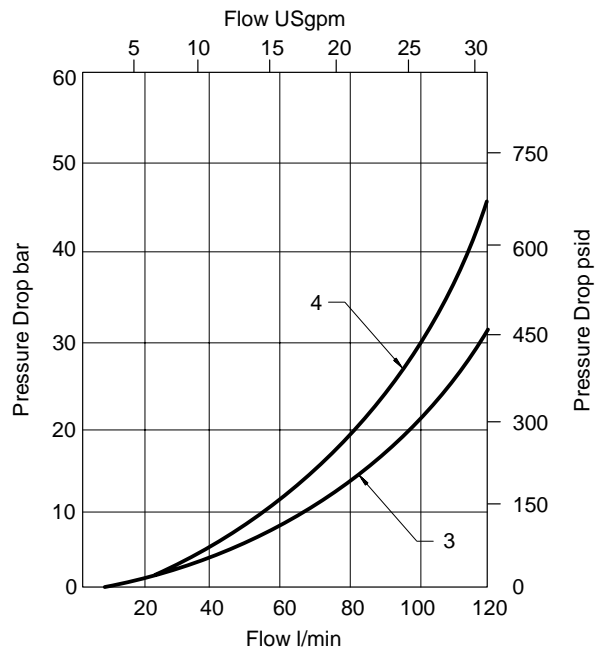
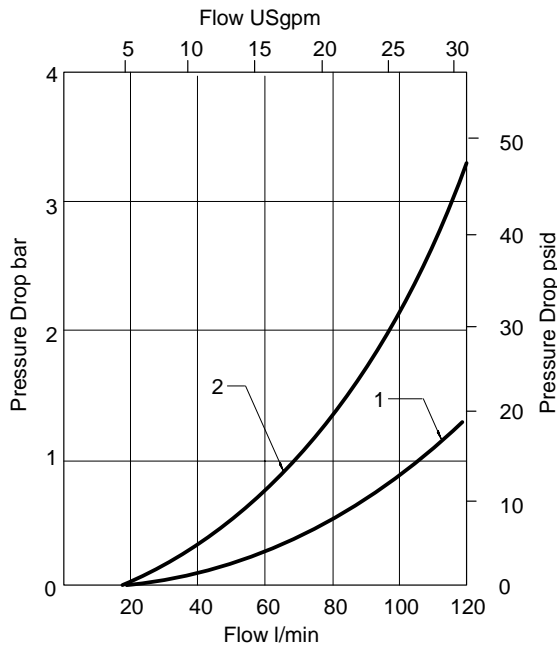

Installation Dimensions

DGMR-5-A*-FW-B*-FW-30 Dual Counterbalance on A & B Ports

mm (inches)

See page 37 for optional adjustment devices.
See page 38 for interface dimensions.

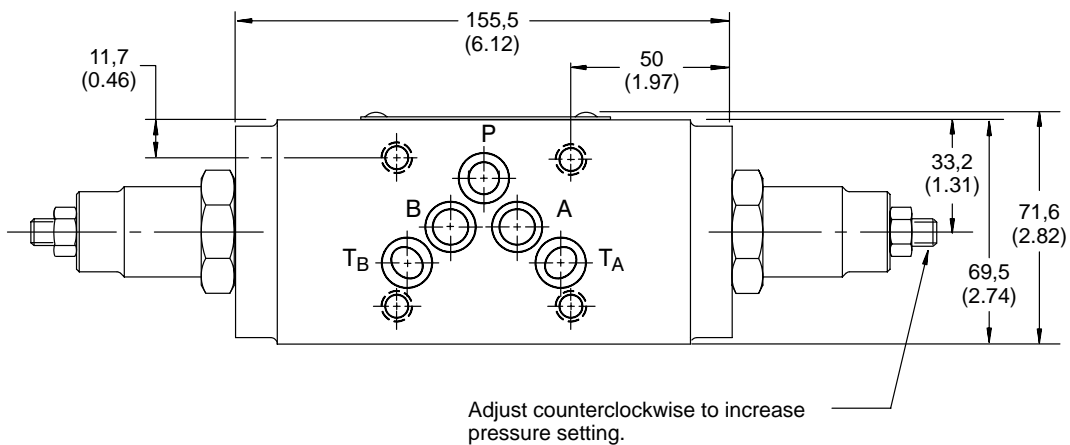
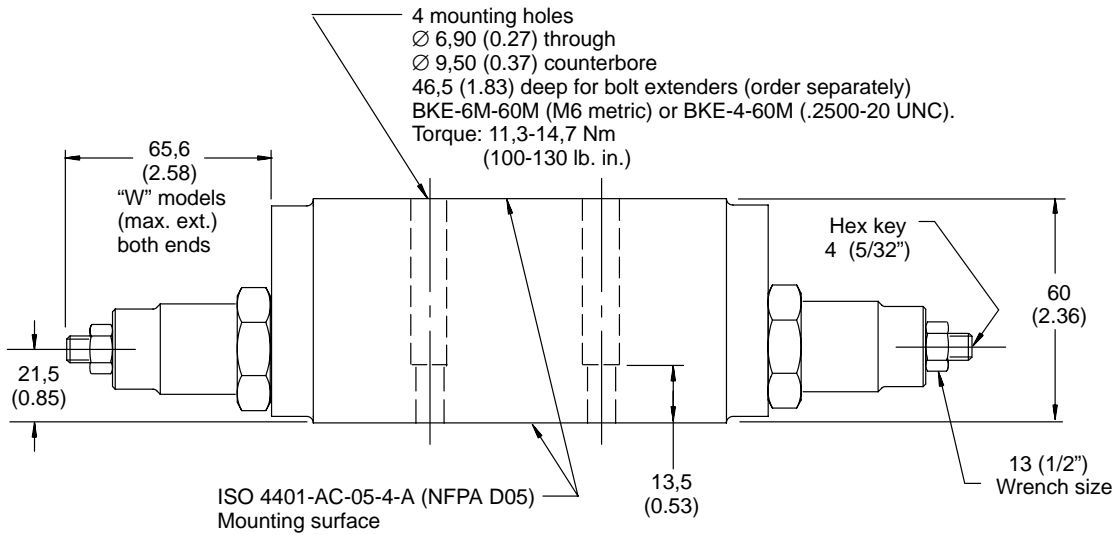
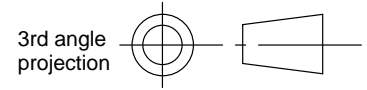

DGMR-5-A*-FW-30
Counterbalance Port A,
Piloted from B
 mm (inches)

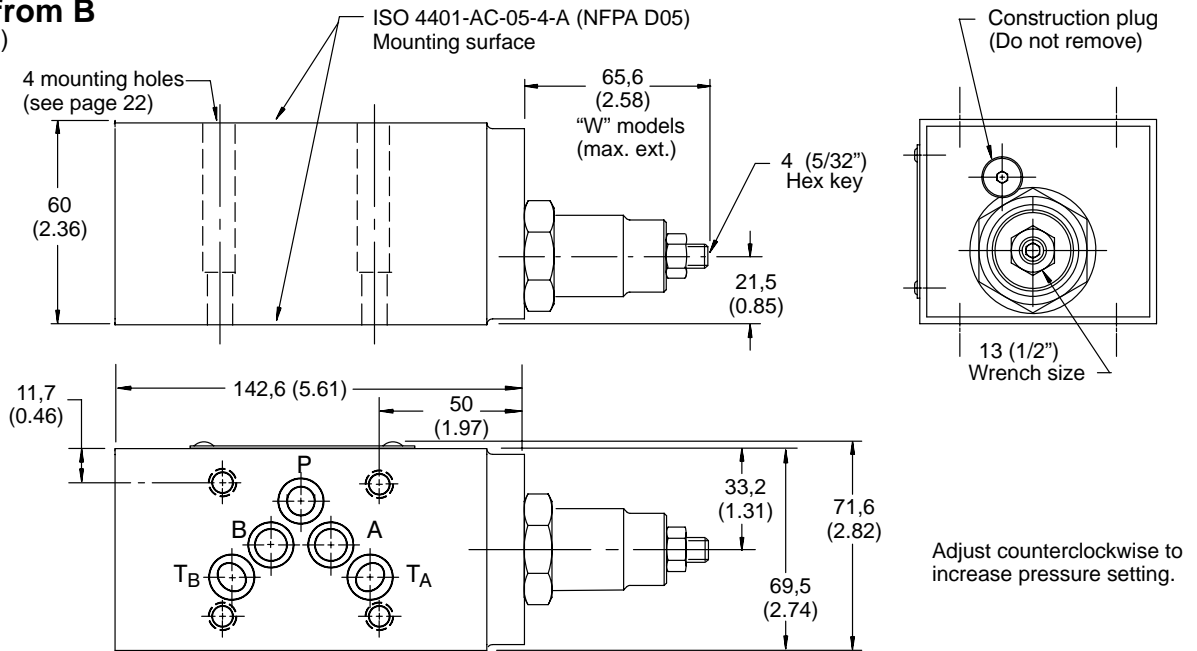

See page 37 for optional adjustment devices.
 See page 38 for interface dimensions.

DGMR-5-B*-FW-30
Counterbalance Port B,
Piloted from A

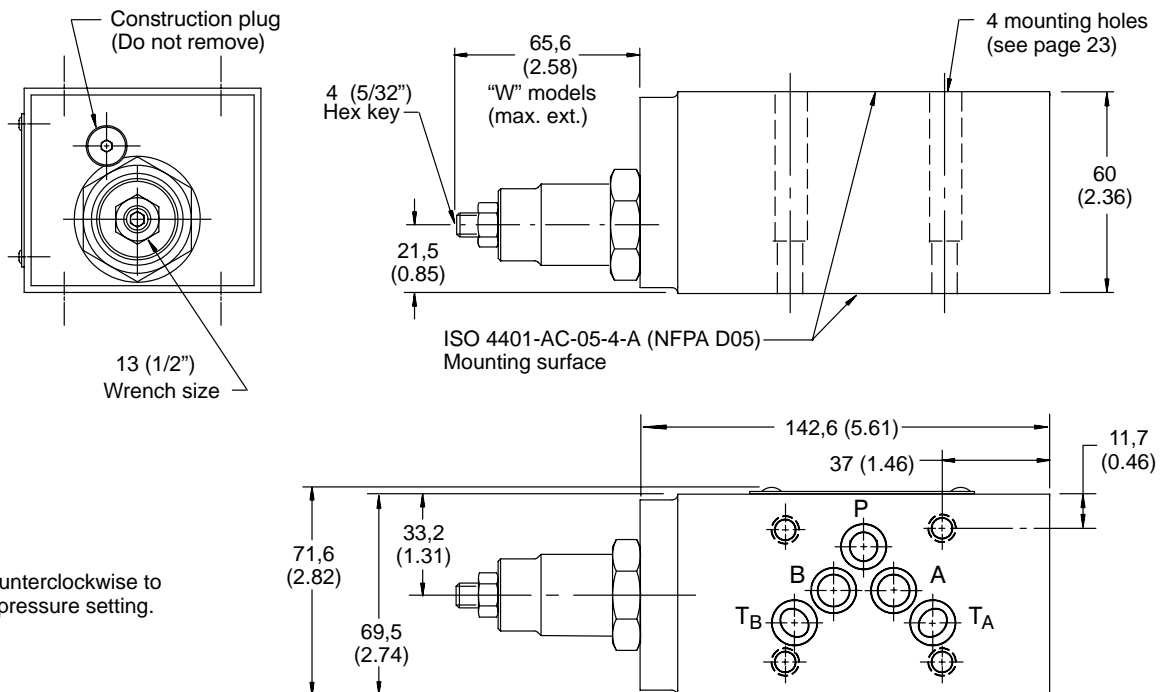

DGMFN Flow Control Valves

General Description

These valves are adjustable, non-compensated flow restrictors. An integral check valve around the regulating orifice allows free flow in one direction and metered flow in the other.

Control is available in "A" only, "B" only, and "A" and "B" ports as an "X" type

(meter-in) or "Y" type (meter-out).

The "P" port is available only in the "X" type (meter-in) and does not contain a reverse flow check.

The valve flow setting is adjustable by means of either a hex key adjusting screw and locknut, a hand-adjust knob,

or a micrometer knob with keylock.

A normal or fine metering capability is available. See the pressure drop curves on page 26 for detailed performance difference.

Model Code

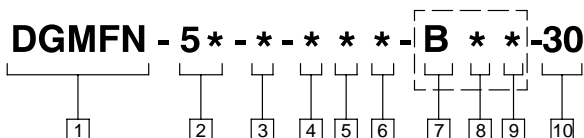

1 Valve function

Manifold or subplate mounted flow control valve.

2 Interface

5 - ISO 4401-AC-05-4-A, CETOP 5
 Size 5 RP35H ANSI/NFPA D05
 5N - NFPA D05 (Alt. A)
 5P - NFPA D05 (Alt. B)

3 Direction of flow

X - Meter-in
 Y - Meter-out

4 Port operated upon

A - Cylinder port "A" (single or dual type)
 B - Cylinder port "B" (single type only)
 P - Pressure port (single type only)

5 Adjustment range

1 - Fine control
 2 - Normal control

6 Adjustment device

H - Knob adjuster
 K - Micrometer knob with keylock
 W - Screw with locknut

7 Port operated upon: second function

(Omit for single flow control models.)
 B - B cylinder port (Dual type)

8 Adjustment range: second function

(Omit for single flow control models.)
 1 - Fine control
 2 - Normal control

9 Adjustment device: second function

(Omit for single flow control models.)
 H - Knob adjuster
 K - Micrometer knob with keylock
 W - Screw with locknu

10 Design number - 30 series

Subject to change. Installation dimensions unaltered for design numbers 30 to 39 inclusive.

Functional Symbols

DGMFN-5-X-P**-30

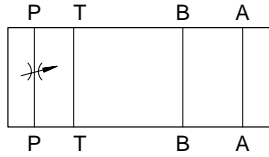

DGMFN-5N-X-P**-30
(models not available)

DGMFN-5P-X-P**-30

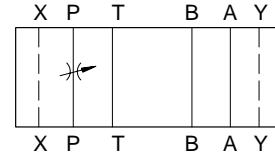

DGMFN-5-X-A**-B**-30

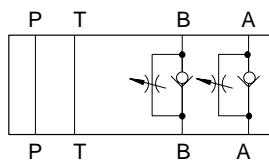

DGMFN-5N-X-A**-B**-30

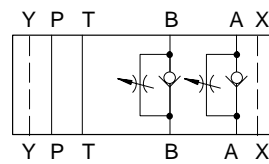

DGMFN-5P-X-A**-B**-30

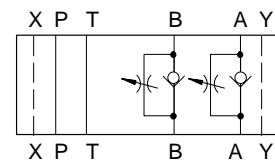

DGMFN-5-X-A**-30

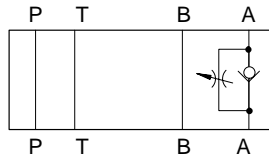

DGMFN-5N-X-A**-30

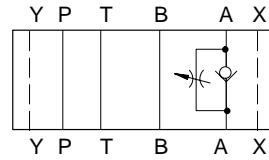

DGMFN-5P-X-A**-30

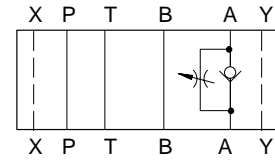

DGMFN-5-X-B**-30

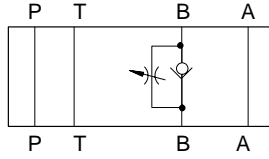

DGMFN-5N-X-B**-30

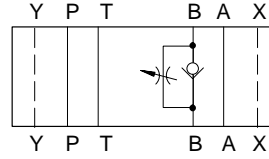

DGMFN-5P-X-B**-30

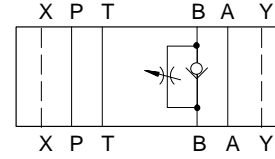

DGMFN-5-Y-A**-B**-30

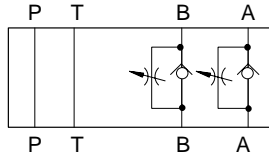

DGMFN-5N-Y-A**-B**-30

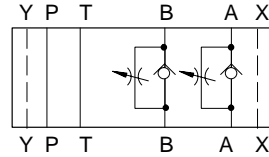

DGMFN-5P-Y-A**-B**-30

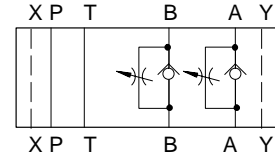

DGMFN-5-Y-A**-30

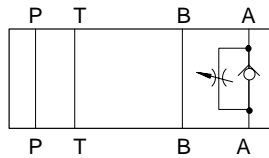

DGMFN-5N-Y-A**-30

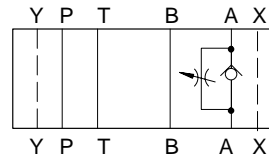

DGMFN-5P-Y-A**-30

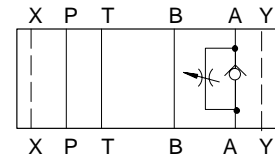

DGMFN-5-Y-B**-30

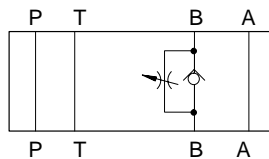

DGMFN-5N-Y-B**-30

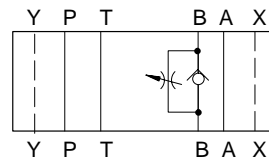

DGMFN-5P-Y-B**-30

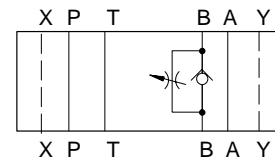

Operating Data

Basic Characteristics

Maximum flow:	120 l/min (32 USgpm)
Maximum operating pressure:	315 bar (4500 psi)
Operating temperature:	20° to 50° C (70° to 120° F)
Weight:	3,1 kg (6.8 lbs.)

Minimum Controlled Flow/No-Flow Leakage

Internal leakage will vary from valve to valve and with the pressure differential across the check.

Approximate levels are:

Pressure Drop bar (psi)	Leakage* cc/min (in ³ /min)
50 (725)	160 (9.5)
100 (1450)	320 (19)
200 (2900)	640 (38)
315 (4500)	990 (60)

* Equals minimum controllable flow rate at the pressures stated.

Pressure Drop

The curves below show the pressure drop through individual flow passages. Curves labeled "metered flow/pressure drop" refer to the pressure drop through only the passage containing the flow control regulating orifice. Total valve insertion loss is a value derived from graph 1 or 2 plus the appropriate values of lines 1, 2 and 3 from graph 3.

Graph 1

Metered flow pressure drop.
Normal adjustment – "2"
models (see model code,
page 24).

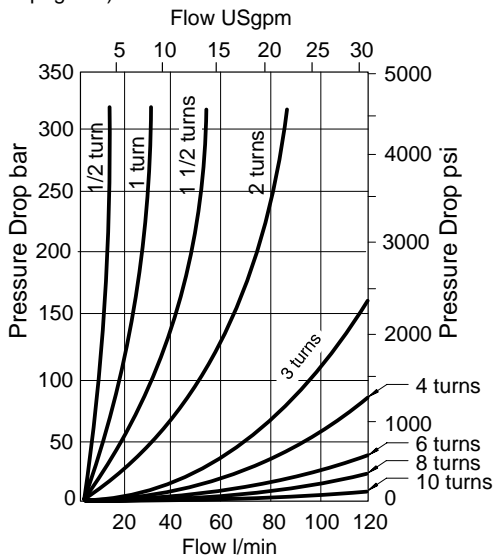

Note: "Turn" or "Turns" on curves in graphs 1 and 2, above, refer to turn of adjustment device from fully closed position.

Graph 2

Metered flow pressure drop.
Fine adjustment – "1"
models (see model code,
page 24).

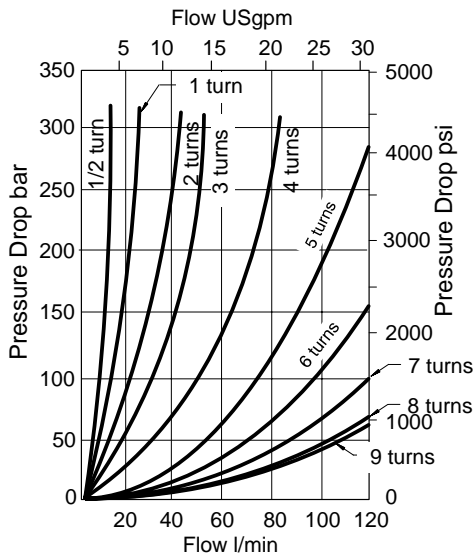

Graph 3

Free flow pressure drop across
check valve.

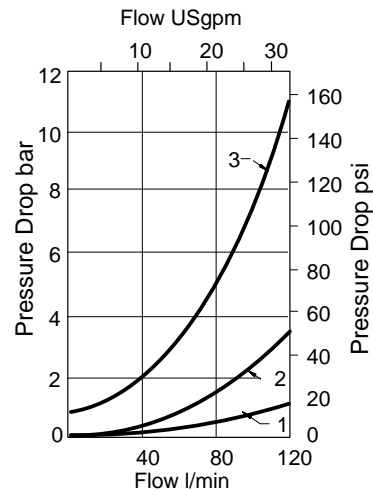

Graph 3

- 1 – "P" port of all models except DGMFN-5-X-P**-30
"B" and "T" ports of DGMFN-5-X-P**-30
- 2 – "T" port of all models except DGMFN-5-X-P**-30
"A" ports of DGMFN-5-X-P**-30
- 3 – Pressure drop across reverse free flow check valve

Installation Dimensions

DGMFN-5-X-P & DGMFN-5-Y-A Single Flow Controls

mm (inches)

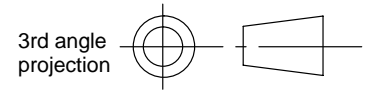

4 mounting holes \varnothing 6,9 (0.27) through
 \varnothing 9,50 (0.37) counterbore 36,5 (1.44) deep
 for bolt extenders (order separately)
 BKE-6M-50M (M6 metric) or
 BKE-4-50M (.2500-20 UNC).
 Torque: 11,3-14,7 Nm (100-130 lb. in.)

Model	A	B
DGMFN-5-X-P	60,4 (2.38)	28,4 (1.12)
DGMFN-5-Y-A	52,7 (2.07)	33,2 (1.31)

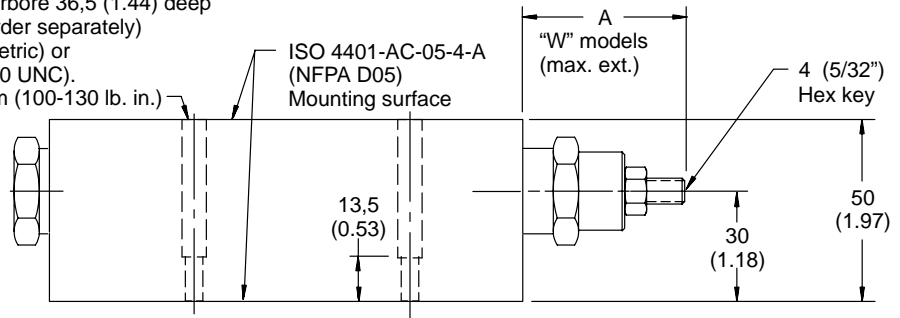

No hex plug on
 DGMFN-5-X-P
 models

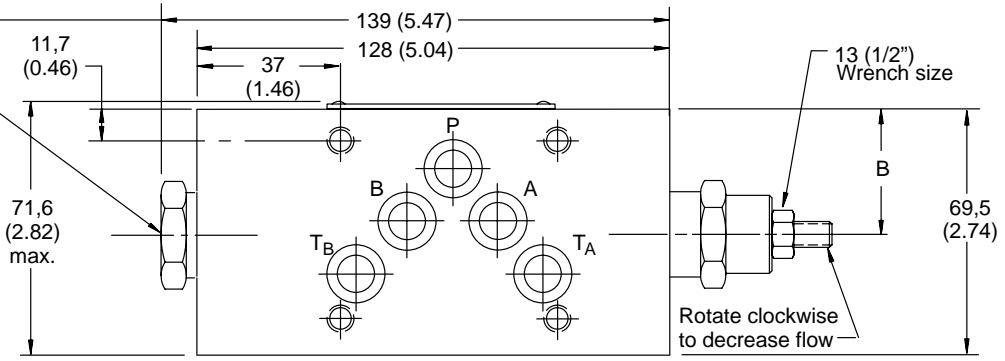

See page 37 for optional adjustment devices.
 See page 38 for interface dimensions.

DGMFN-5-X-A Single Flow Control

mm (inches)

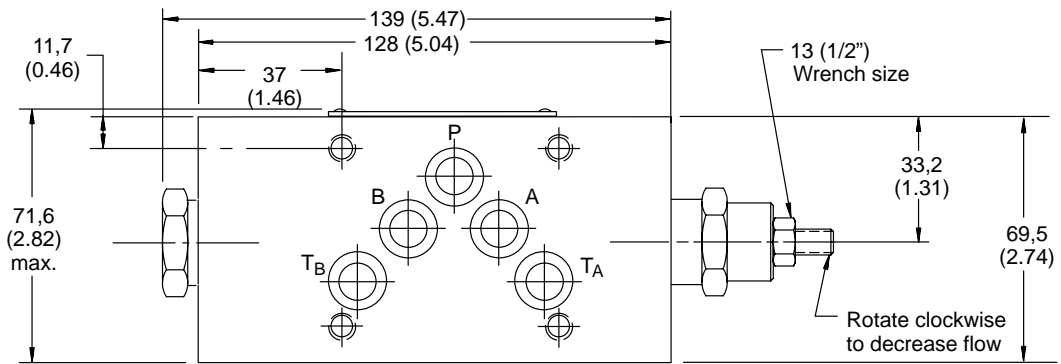
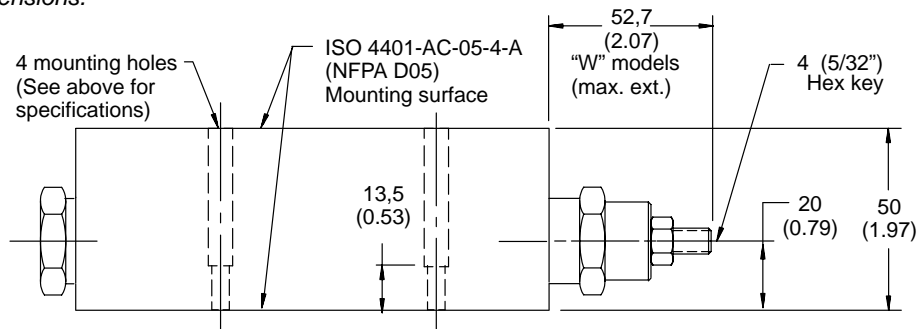

DGMFN-5-X-B
Single Flow Control

mm (inches)

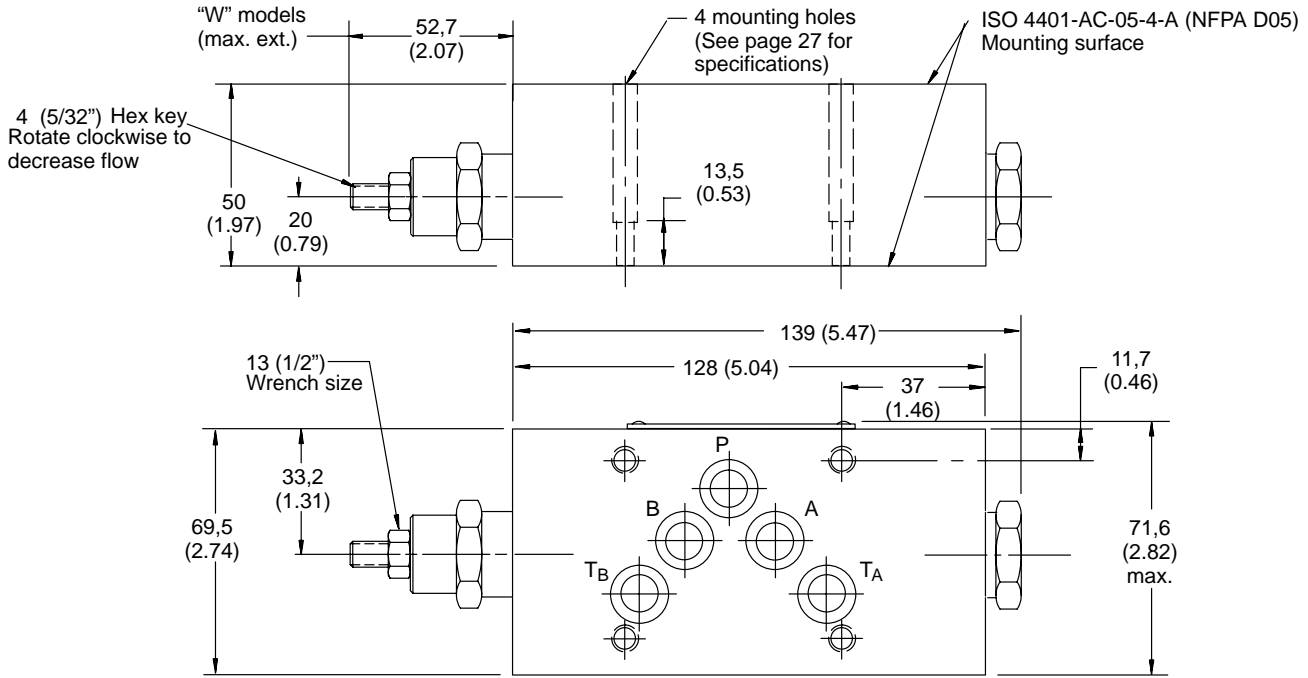

See page 37 for optional adjustment devices.
 See page 38 for interface dimensions.

DGMFN-5-Y-B
Single Flow Control

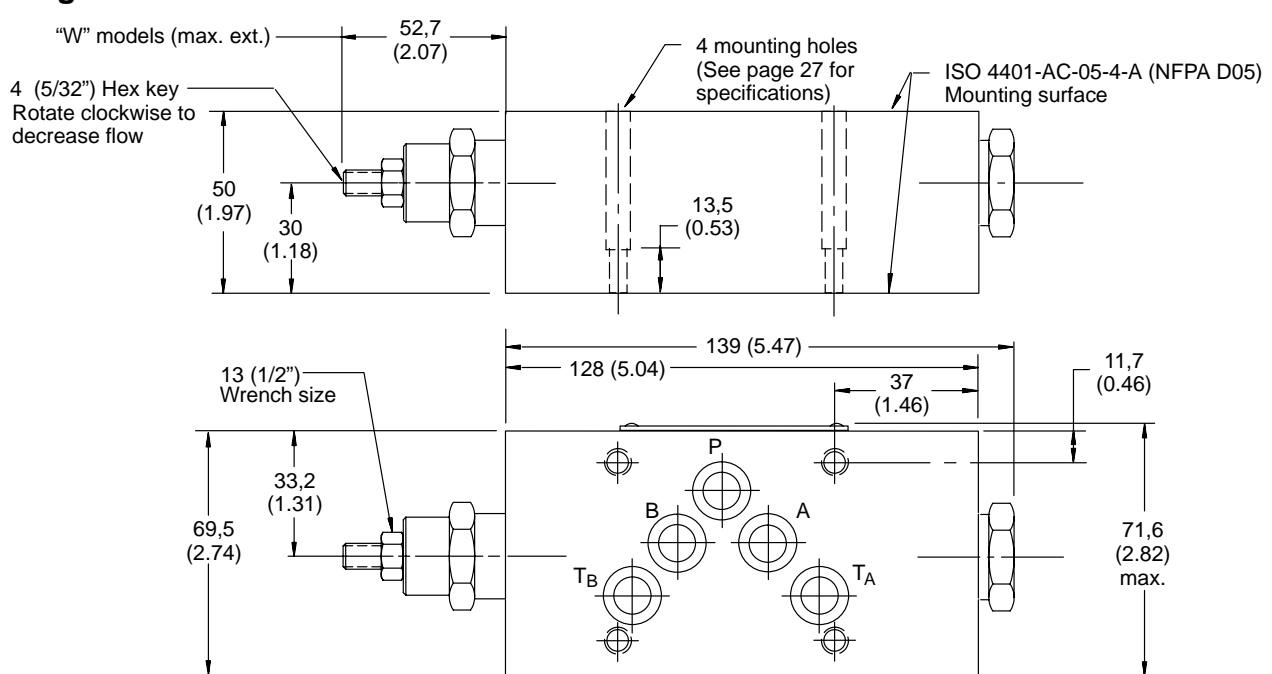

DGMFN-5-Y Dual Flow Control

mm (inches)

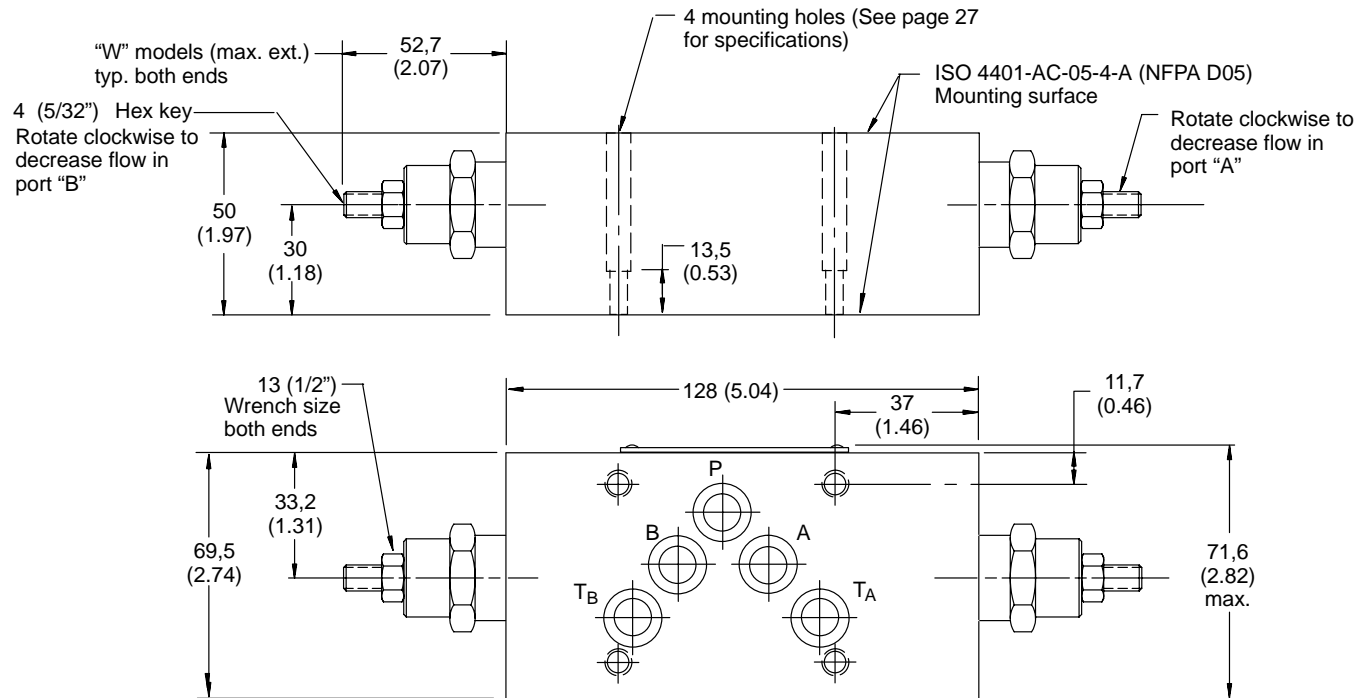

See page 37 for optional adjustment devices.

See page 38 for interface dimensions.

DGMFN-5-X Dual Flow Control

mm (inches)

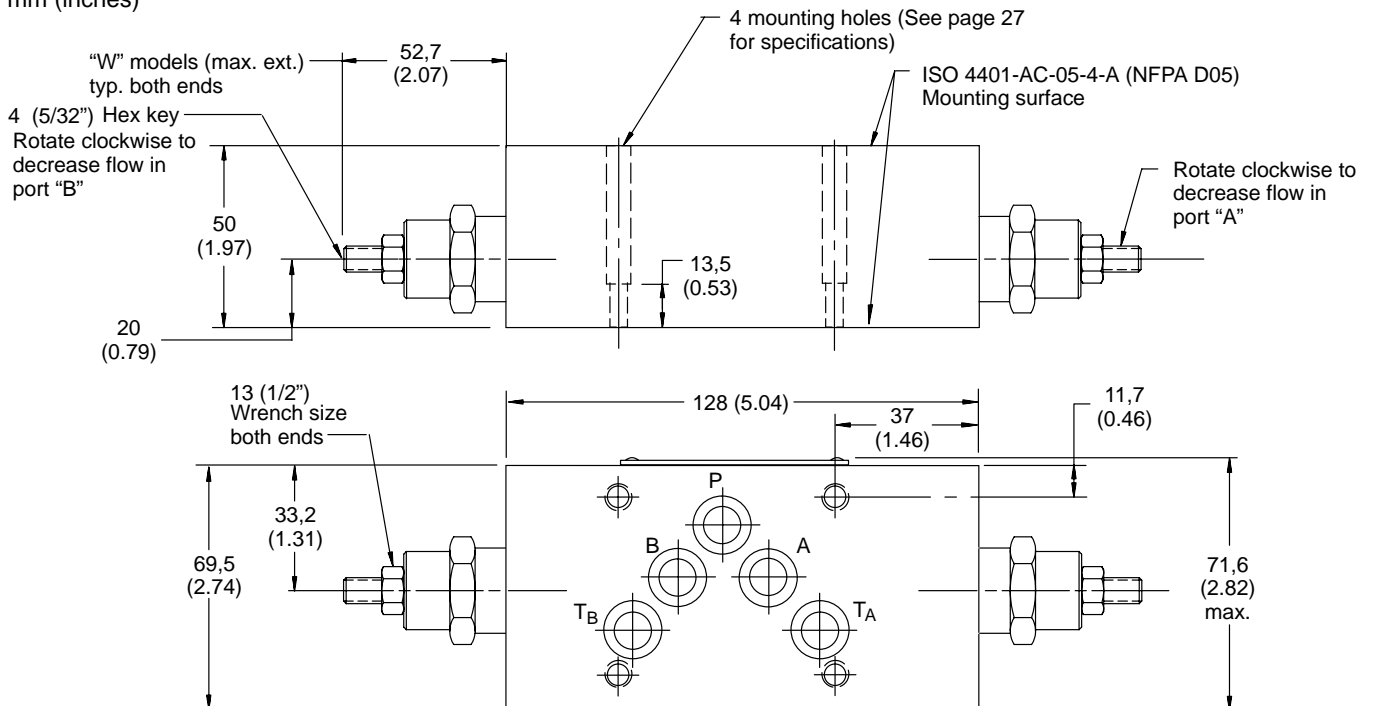

DGMPC Pilot Operated Check Valves

General Description

These valves are single or dual check units. Dual check units have identical check elements located in the "A" and "B" cylinder port lines. The check valve poppets are moved into the open position by a central pilot control spool which moves toward one check or the other, depending on which port is pressurized.

The check valve located in the return circuit is opened by the operating pressure in the primary circuit. When the pressure in the pilot line is vented, the check valve will remain closed.

The pilot spool area to valve seat ratio is 3:1 on standard models, and 20:1 on models with the decompression feature.

Check valve cracking (opening) pressures of 1 bar (15 psi), 2,5 bar (36 psi) and 5 bar (73 psi) are available. Please note that back pressure on the downstream or free-flow side of the pilot check valve may prevent the valve from opening in certain situations. (Back pressure opposes pilot pressure trying to open the valve.) In such cases, pilot pressure required to open the decompression poppet and valve can be calculated as follows:

To open valve or poppet in line A:

$$\text{Pressure at } B_1 = \frac{P_A + P_C - P_{A1}}{\text{Area ratio factor}} + P_{A1}$$

To open valve or poppet in line B:

$$\text{Pressure at } A_1 = \frac{P_B + P_C - P_{B1}}{\text{Area ratio factor}} + P_{B1}$$

Where:

P_A = Pressure at A
 P_C = Cracking pressure
 P_{A1} = Pressure at A_1
 P_B = Pressure at B
 P_{B1} = Pressure at B_1

In the above cases, substitute cracking pressure and area ratio from the following:

Cracking pressure: 1, 2.5 or 5 bar according to model code position 6 (and position 10 for second function).

Area ratio factors:

Standard valve: 3
 Decompression poppet: 20

Model Code

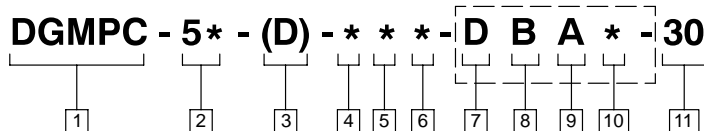

1 Valve function

Manifold or subplate mounted check valve.

2 Interface

5 - ISO 4401-AC-05-4-A, CETOP RP35H, Size 5 ANSI/NFPA D05
 5N - NFPA D05 (Alt. A)
 5P - NFPA D05 (Alt. B)

3 Decompression feature

D - With decompression feature
 Blank - Standard (no decompression)

4 Check port

A - Check in cylinder port "A"
 B - Check in cylinder port "B"
 (single check models only)

5 Pilot port

A - Pilot port controlling the "B" port check (single check models only)
 B - Pilot port controlling the "A" port check

6 Cracking pressure

K - 1,0 bar (15 psi)
 M - 2,5 bar (35 psi)
 N - 5,0 bar (75 psi)

7 Decompression feature

D - Decompression feature
 Blank - Standard (no decompression)
 Omit for single check models.

8 Check port: second function

B - Check in cylinder port "B"
 Omit for single check models.

9 Pilot port: second function

A - Pilot port controlling the "B" port check (dual check models only)
 Omit for single check models.

10 Cracking pressure: second function

K - 1,0 bar (15 psi)
 M - 2,5 bar (35 psi)
 N - 5,0 bar (75 psi)
 Omit for single check models.

11 Design number - 30 series

Subject to change. Installation dimensions unaltered for design numbers 30 to 39 inclusive.

Operating Data

Functional Symbols

DGMPC-5-AB*-30

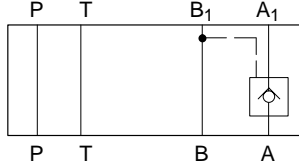

DGMPC-5N-AB*-30

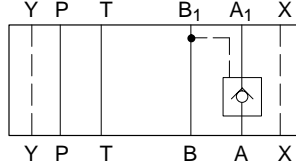

DGMPC-5P-AB*-30

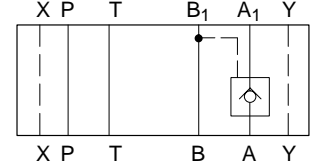

DGMPC-5-BA*-30

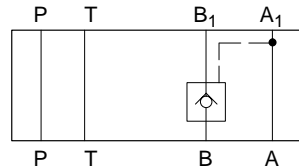

DGMPC-5N-BA*-30

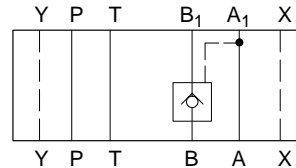

DGMPC-5P-BA*-30

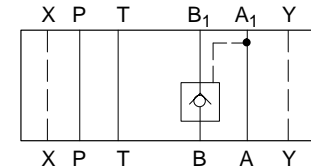

DGMPC-5-AB*-BA*-30

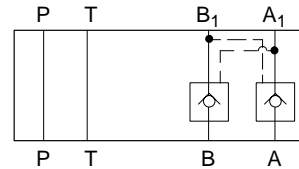

DGMPC-5N-AB*-BA*-30

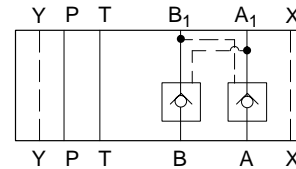

DGMPC-5P-AB*-BA*-30

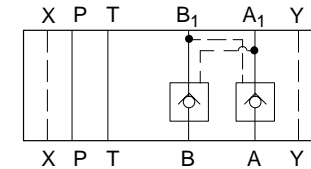

Basic Characteristics

Maximum flow rate:	120 l/min (32 USgpm)
Maximum operating pressure:	315 bar (4500 psi)
Leakage @ 50° C (120° F)	
Poppet @ 35 bar (500 psi)	
Standard models	0.3 ml/min.
"D" models	1.0 ml/min.
Piston @315 bar (4500 psi)	200 ml/min.
Operating Temperature:	20° C to 50° C (70° to 120° F)
Weight:	2,9 kg (6.4 lbs)

DGMPC Pressure Drop

The curves below show pressure drop through each functional flow path in the valve. The total insertion loss for the valve must be calculated by summing the losses through the four applicable flow paths.

Model Type	Curve Number							
	P	T	A		B			
DGMPC-5-(D)-AB*-30	1	2	—	5	▲	●3 ■4	—	—
DGMPC-5-(D)-BA*-30	1	2	●3 ■4	—	—	—	5	▲
DGMPC-5-(D)-AB*-(D)-BA*-30	1	2	—	5	▲	—	5	▲

- Flow toward actuator without check – single check only
- Flow from actuator without check – single check only
- ▲ Use K, M, or N cracking pressure curve as applicable.

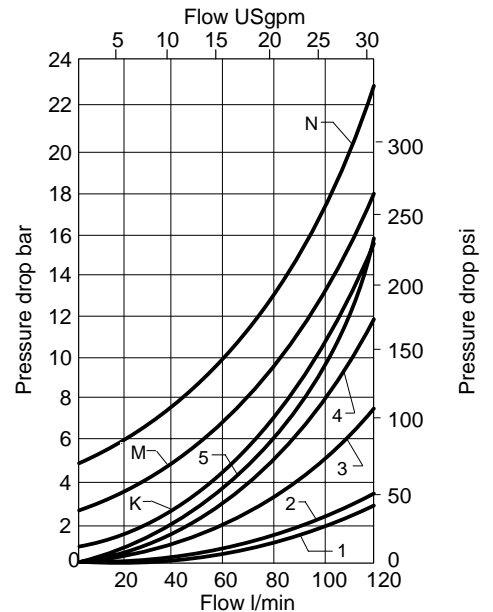

Installation Dimensions

DGMPC-5-30 Pilot Operated Check Valve

mm (inches)

See page 38 for interface dimensions.

4 mounting holes
Ø 6,9 (0.27) through
Ø 9,50 (0.37) counterbore
36,5 (1.44) deep
for bolt extenders
(order separately)
BKE-6M-50M (M6 metric) or
BKE-4-50M (.2500-20 UNC)
Torque: 11,3-14,7 Nm
(100-130 lb. in.)

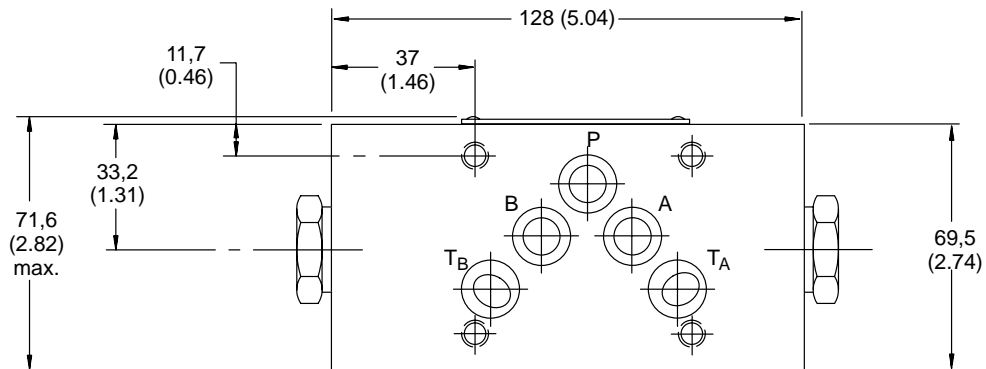
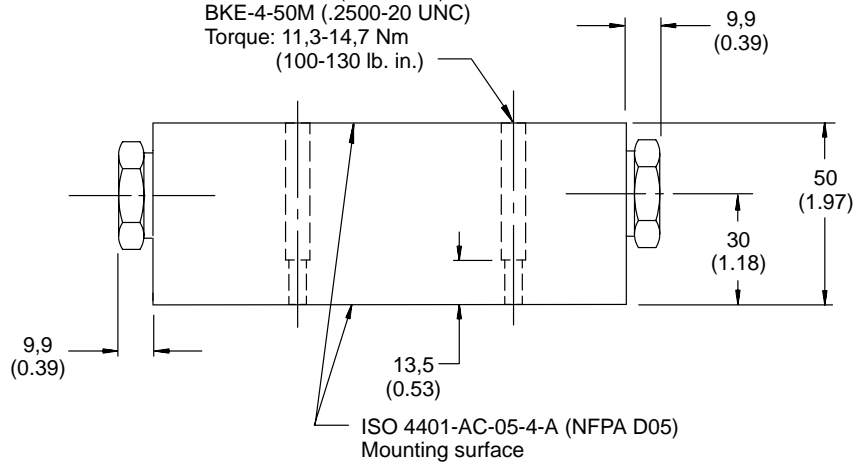

DGMDC Direct Check Valves

General Description

These SystemStak valves are self-operating, spring loaded, poppet type single or dual check units.

Location of the check element can be in the "A", "B", "P" or "T" port.

A check in the "P" port is available as a "Y" single check model only.

A check in the "T" port is available as an "X" single check model only.

The dual check unit has identical check elements in both the "A" and "B" ports.

Check valve cracking (opening) pressures of 1 bar (15 psi), 2,5 bar (35 psi) and 5 bar (75 psi) are available.

Model Code

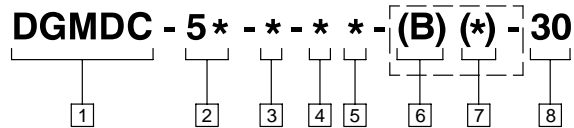

1 Valve function

Manifold or subplate mounted check valve.

2 Interface

5 - ISO 4401-AC-05-4-A, CETOP RP35H, Size 5 ANSI/NFPA D05
 5N - NFPA D05 (Alt. A)
 5P - NFPA D05 (Alt. B)

3 Direction of flow

X - Free flow from actuator (load)
 Y - Free flow to actuator (load)

4 Check location

A - Check in cylinder port "A" ("Y" models only)
 B - Check in cylinder port "B" ("Y" models only)
 P - Check in pressure port "P" ("Y" models only)
 T - Check in tank port "T_A" ("X" models only)

5 Cracking pressure

K - 1,0 bar (15 psi)
 M - 2,5 bar (35 psi)
 N - 5,0 bar (75 psi)

6 Check location: second function

Omit for single check models.
 B - Check in cylinder port "B" (dual check models only)

7 Cracking pressure: second function

Omit for single check models.

K - 1,0 bar (15 psi)
 M - 2,5 bar (35 psi)
 N - 5,0 bar (75 psi)

8 Design number - 30 series

Subject to change. Installation dimensions unaltered for design numbers 30 to 39 inclusive.

Functional Symbols

DGMDC-5-Y-P*-30

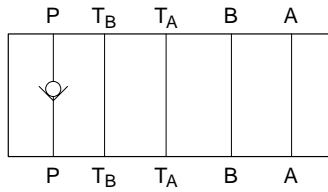

DGMDC-5P-Y-P*-30

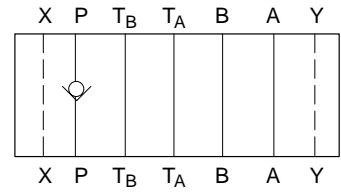

DGMDC-5-Y-B*-30

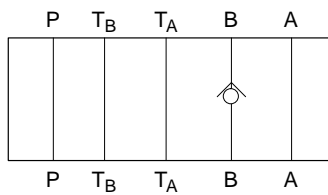

DGMDC-5N-Y-B*-30

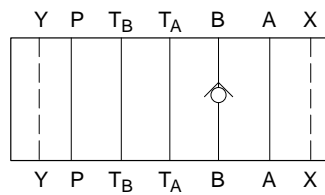

DGMDC-5P-Y-B*-30

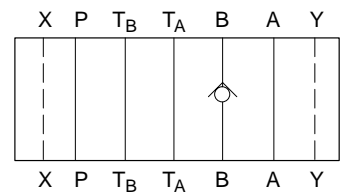

DGMDC-5-X-T*-30

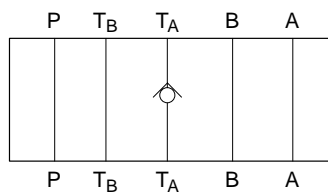

DGMDC-5N-X-T*-30

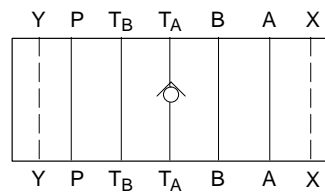

DGMDC-5P-X-T*-30

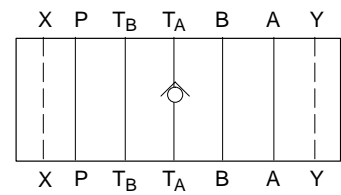

DGMDC-5-Y-A*-B*-30

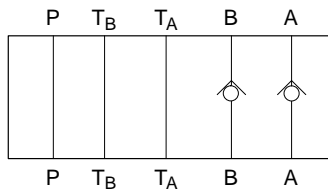

DGMDC-5N-Y-A*-B*-30

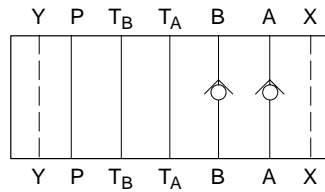

DGMDC-5P-Y-A*-B*-30

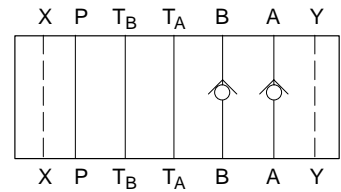

DGMDC-5-Y-A*-30

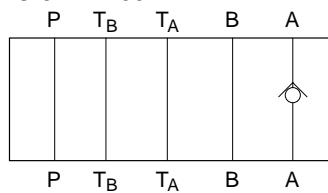

DGMDC-5N-Y-A*-30

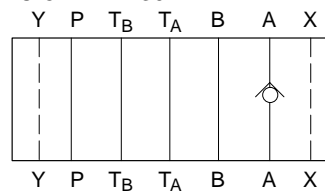

DGMDC-5P-Y-A*-30

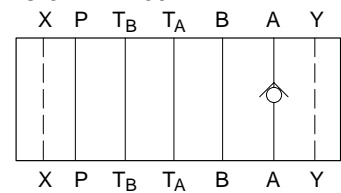

Operating Data

Basic Characteristics

Maximum flow:	120 l/min (32 USgpm)
Maximum operating pressure:	315 bar (4500 psi)
Leakage @ 50° C (120° F) and 35 bar (500 psi)	0.3 ml/min.
Operating temperature:	20° to 50° C (70° to 120° F)
Weight:	2,9 kg (6.4 lbs.)

Pressure Drop

These curves show pressure drop through each possible flow path in the valve. The total insertion loss for the

valve must be calculated by summing the losses through the four applicable flow paths.

Model Type	Curve Reference for Flow Path				Graph Number
	P	T	A	B	
DGMDC-5-Y-PK-30 DGMDC-5-Y-PM-30 DGMDC-5-Y-PN-30	K M N	T	A	B	1
DGMDC-5-X-TK-30 DGMDC-5-X-TM-30 DGMDC-5-X-TN-30	P	K M N	A	B	
DGMDC-5-Y-AK-30 DGMDC-5-Y-AM-30 DGMDC-5-Y-AN-30	P	T	K M N	●1 ■2	
DGMDC-5-Y-BK-30 DGMDC-5-Y-BM-30 DGMDC-5-Y-BN-30	P	T	●1 ■2	K M N	
DGMDC-5-Y-A*-B*-30	P	T	▲	▲	

- Flow to actuator through cylinder port without check
- Flow from actuator through cylinder port without check
- ▲ Use K, M, or N curve from graph 3, as applicable

Graph 1

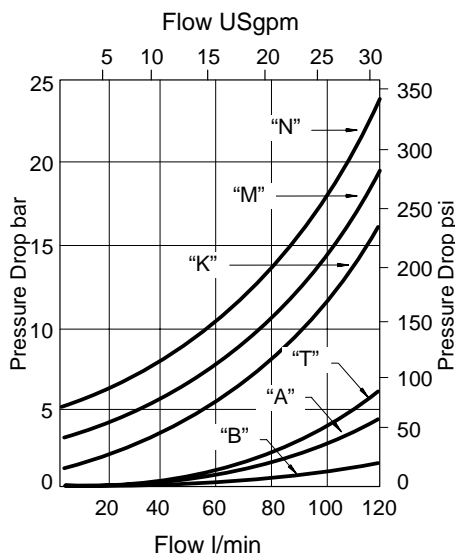

Graph 2

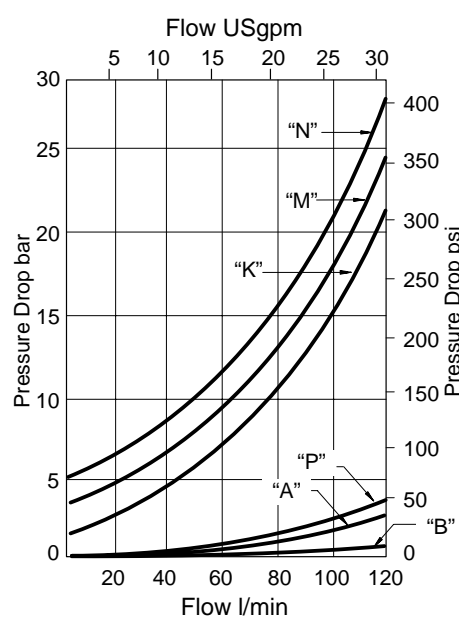

Graph 3

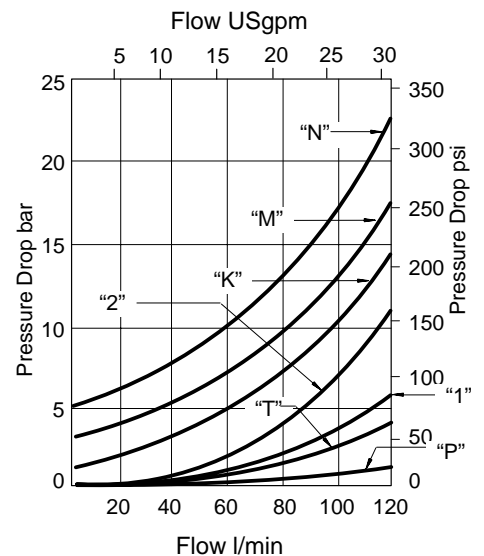

Installation Dimensions

DGMDC-5-Y-A*-B*-30 Dual Direct Check Valve

mm (inches)

4 mounting holes \varnothing 6,9 (0.27) through \varnothing 9,50 (0.37) counterbore 36,5 (1.44) deep for bolt extenders (order separately) BKE-6M-50M (M6 metric) or BKE-4-50M (.2500-20 UNC). Torque: 11,3-14,7 Nm (100-130 lb. in.)

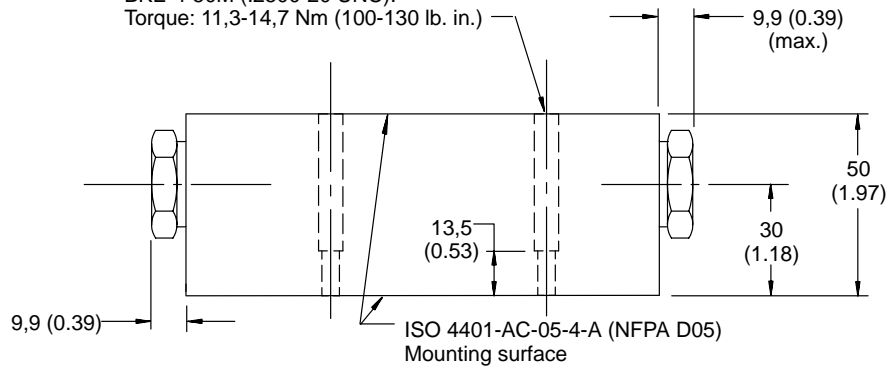

See page 38 for interface dimensions.

DGMDC-5-Y-P*-30 Single Direct Check Valve

DGMDC-5-X-T*-30 Single Direct Check Valve

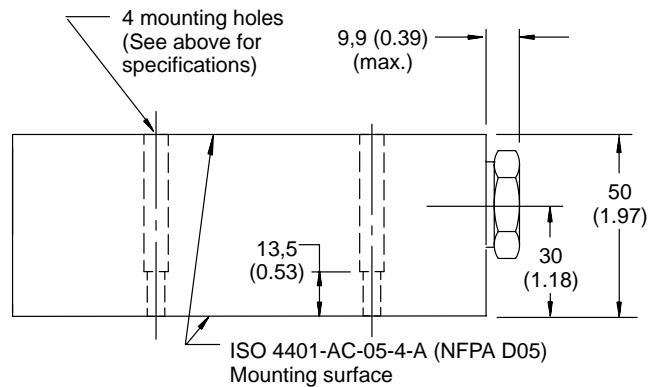
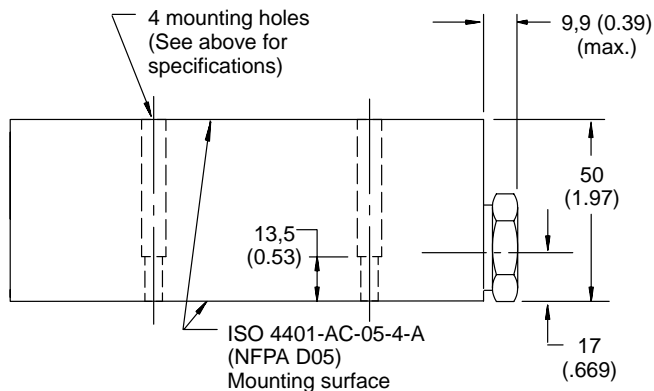

Knob Adjusters

DGMC DGMC2 (dual type) DGMR1 DGMX2

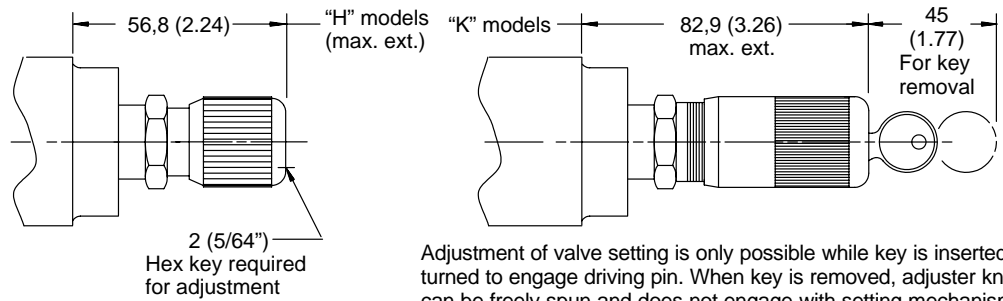

Adjustment of valve setting is only possible while key is inserted and turned to engage driving pin. When key is removed, adjuster knob can be freely spun and does not engage with setting mechanism.

DGMC2 (crossport type)

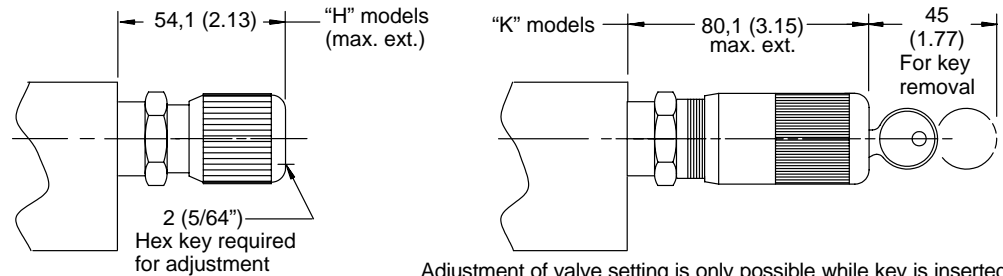

Adjustment of valve setting is only possible while key is inserted and turned to engage driving pin. When key is removed, adjuster knob can be freely spun and does not engage with setting mechanism.

DGMFN

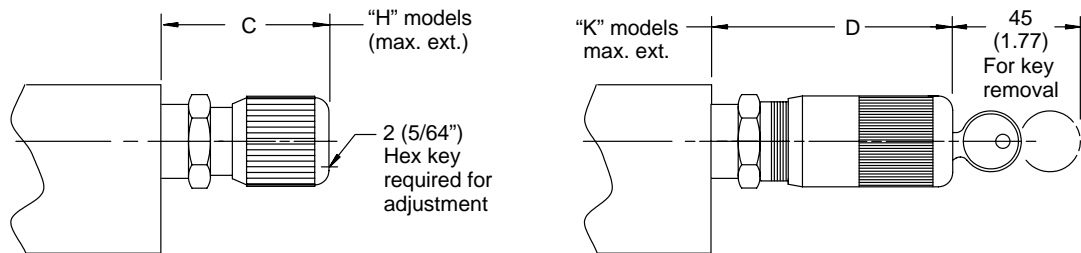

Model	C	D
DGMFN-5-X-P	68,9 (2.37)	95 (3.74)
DGMFN-5-Y-A	61,9 (2.44)	88 (3.46)

Adjustment of valve setting is only possible while key is inserted and turned to engage driving pin. When key is removed, adjuster knob can be freely spun and does not engage with setting mechanism.

DGMR

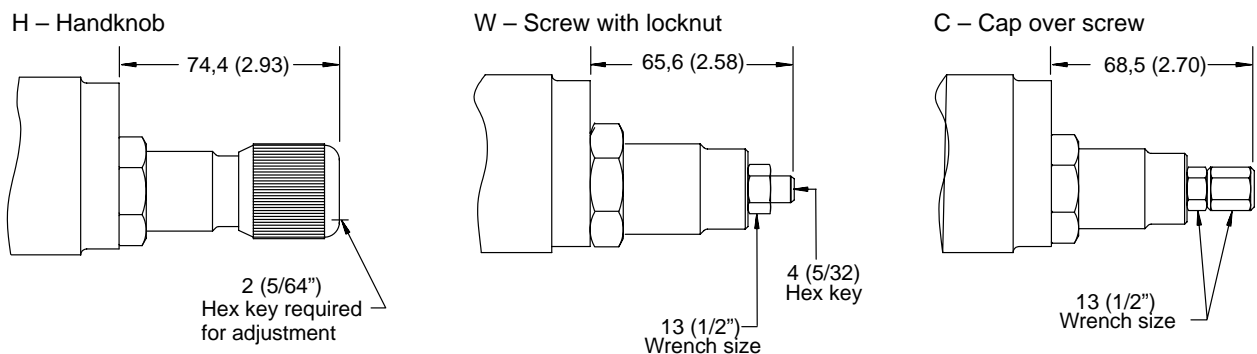

Mounting Surface

Dimensions mm (inches)

DGM**-5

The "5" interface accepts Vickers DG4S4 directional valves and other directional valves with a standard ISO 4401-05, NFPA-D05, ANSI/B93.7M size D05 or CETOP-5 port pattern.

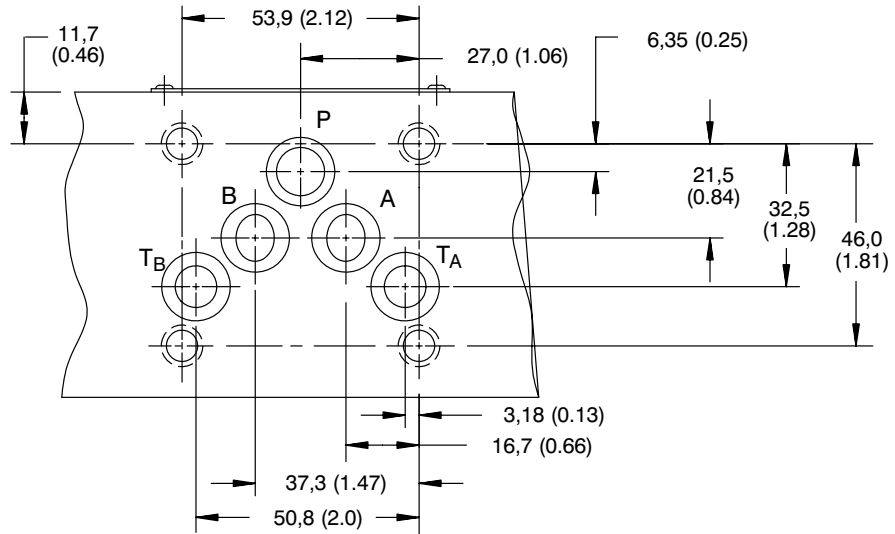

DGM**-5N

The "5N" NFPA-D05 interface accepts Vickers DG3S-5, DG5S-5, DG5V-5 and DG18S4-01 directional valves.

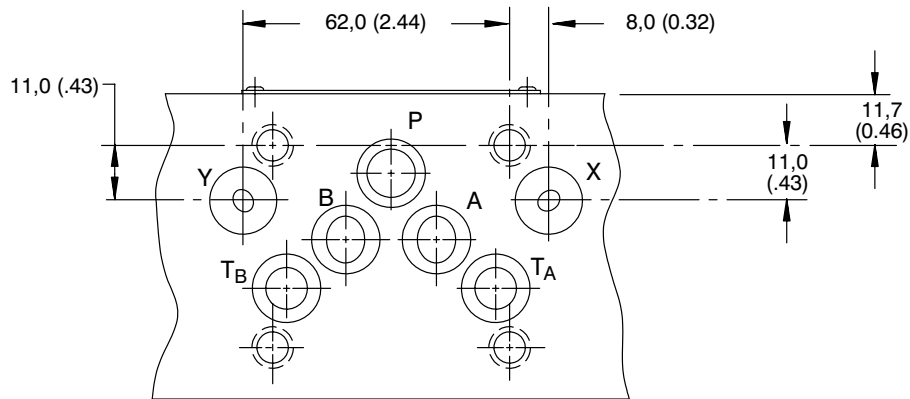

DGM**-5P

The "5P" NFPA-D05 interface accepts Vickers DG5S4-02 directional valves.

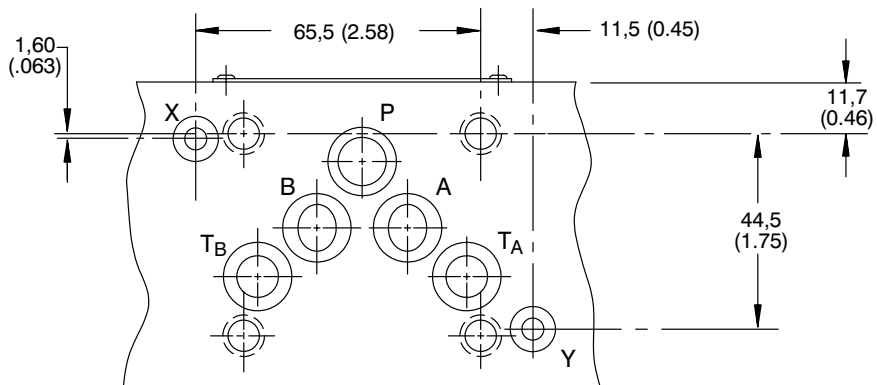

Bolt Extender Kits

ISO 4401-05 SystemStak valves may be mounted with either standard cap screws or bolt extender kits.

Metric cap screws must be of Class 12,9 (ISO 898) strength, minimum U.T.S. = 1200 MPa.

Inch threaded screws must conform to ANSI B18.3.

The use of Vickers bolt extenders simplifies installation by permitting each valve body to be separately installed with the correct torque value. A major

advantage of bolt extenders is the ability to remove the directional valve for service or replacement without disturbing the stack assembly. *There are 4 bolt extenders per kit.*

SystemStak Valve Height mm (inch)	Metric		Inch		Extender Torque
	Thread	Kit Model Number	Thread	Kit Model Number	
50 (1.97)	M6 x 1-6H	BKE-6M-50M	.2500-20 UNC	BKE-4-50M	11,3-14,7 Nm (100-130 lbf in)
60 (2.36)	M6 x 1-6H	BKE-6M-60M	.2500-20 UNC	BKE-4-60M	

Bolt extender cross section

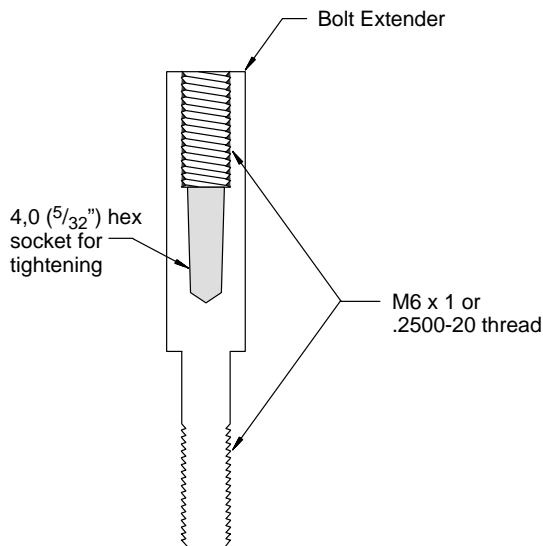

Example of bolt extenders on a typical SystemStak assembly

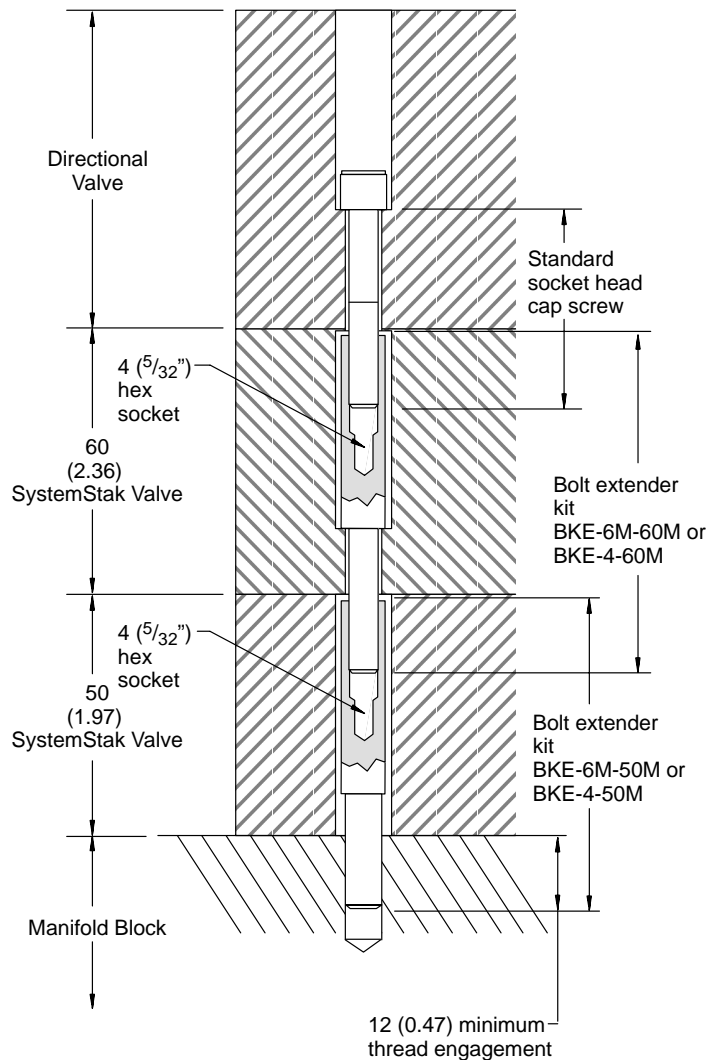

Subplates & Blanking Plate

Valves, subplates and blanking plates must be ordered separately.

DGSM(E) Subplate (rated at 210 bar (3000 psi))

Millimeters (inches)

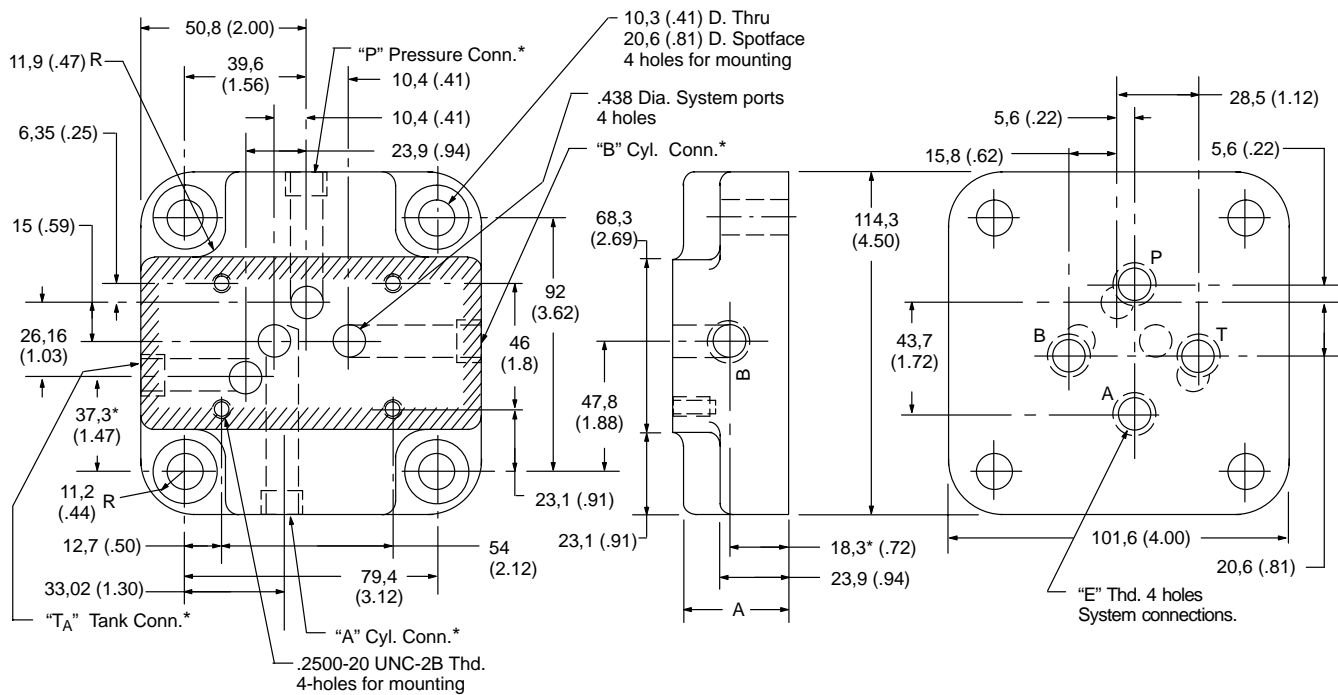

Model Numbers	"E" Thread	Tube Size	Dimension "A"
DGSM-01-20-T8	.750-16 UNF-2B	1/2" O.D.	31,75 (1.25)
DGSME-01-20-T8	.750-16 UNF-2B	1/2" O.D.	38,10 (1.50)

* Ports on side-connection Model DGSME-01-20-T8 only.

DGMAB-5-30 Blanking Plate

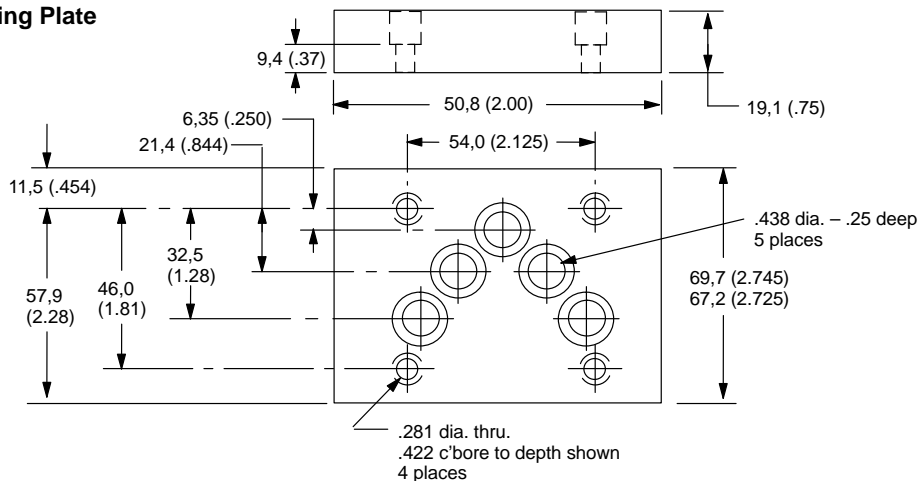

Subplates & Blanking Plates

DGVME Side Ported Subplates (rated at 315 bar (4500 psi)) "5" and "5P" interface

Model	"X"	Assembly
DGVME-5-SP-10-T06	.5625	525815
DGVME-5-SP-10-T08	.7500	525816
DGVME-5-SP-10-T10	.8750	525817
DGVME-5-SP-10-T12	1.0625	525818
DGVME-5-SP-PD-10-T10†	.8750	526003
DGVME-5-SP-PD-10-T12†	1.0625	526004

†Model with pilot and drain ports.

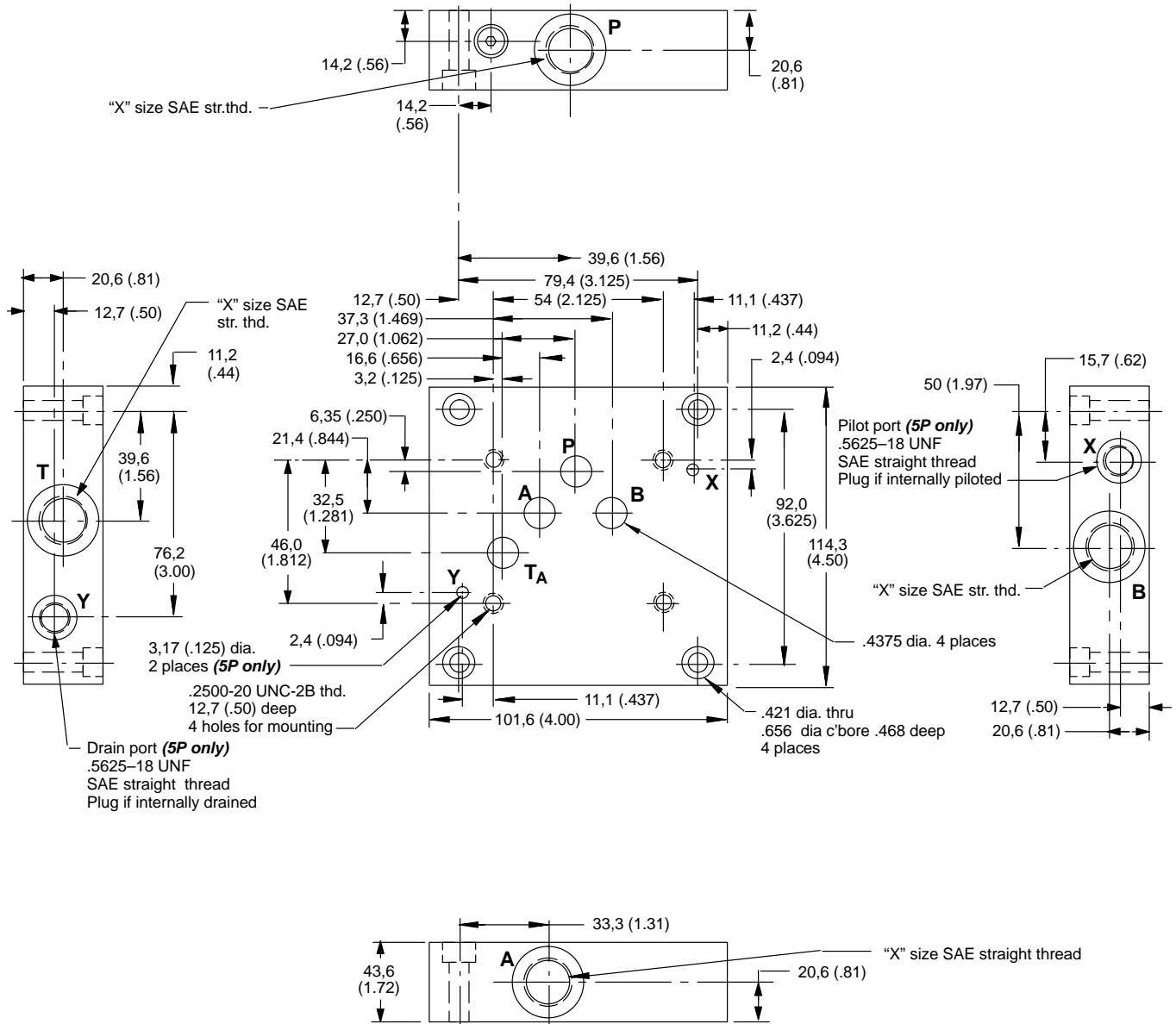

Subplates & Blanking Plates

DGVM Bottom Ported Subplates (rated at 315 bar (4500 psi)) "5" and "5P" interface

Model	"X"	Assembly
DGVM-5-SP-10-T06	.5625	525811
DGVM-5-SP-10-T08	.7500	525812
DGVM-5-SP-10-T10	.8750	525813
DGVM-5-SP-10-T12	1.0625	525814
DGVM-5-SP-PD-10-T10†	.8750	525832
DGVM-5-SP-PD-10-T12†	1.0625	525833

†Model with pilot and drain ports.

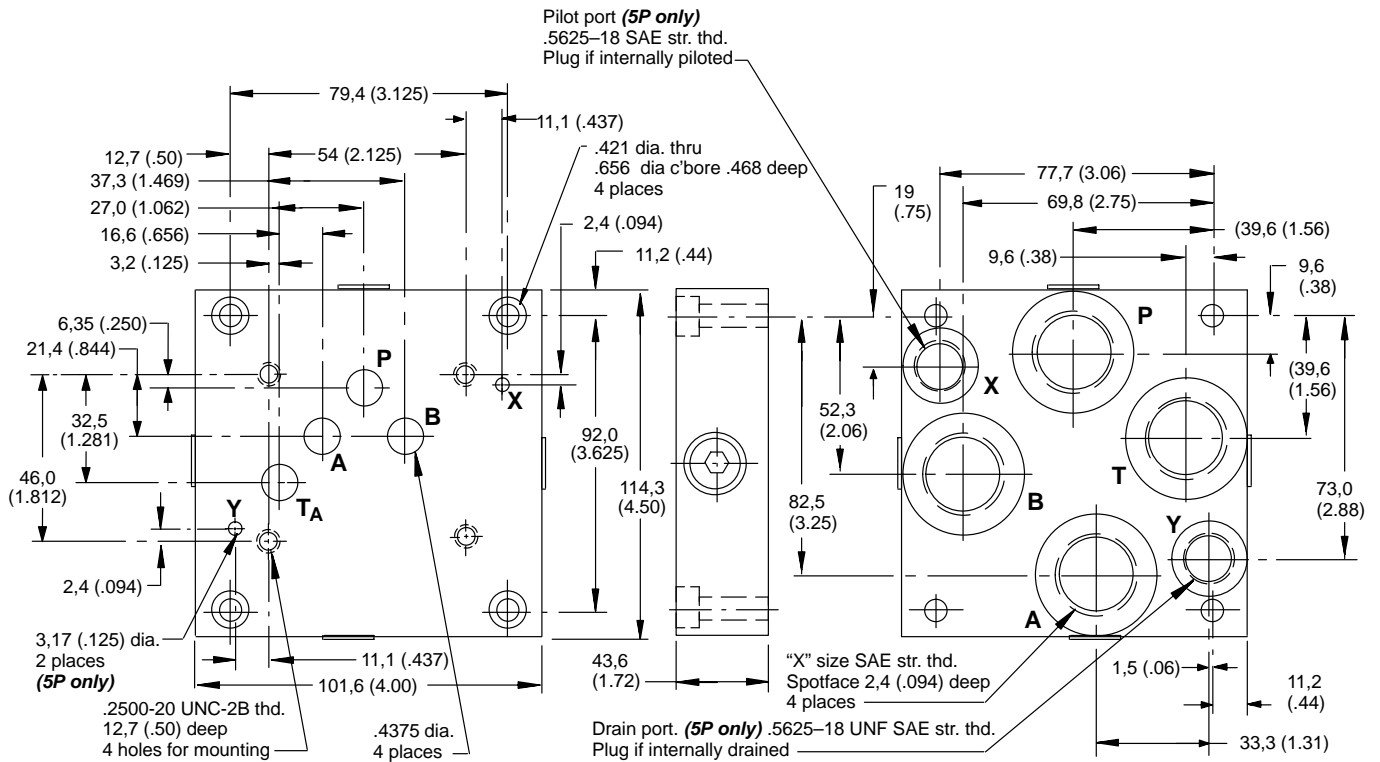

Application Data

Fluid Cleanliness

Proper fluid condition is essential for long and satisfactory life of hydraulic components and systems. Hydraulic fluid must have the correct balance of cleanliness, materials, and additives for protection against wear of components, elevated viscosity, and inclusion of air.

Essential information on the correct methods for treating hydraulic fluid is included in Vickers publication 561 "Vickers Guide to Systemic Contamination Control" available from your local Vickers distributor or by

contacting Vickers, Incorporated. Recommendations on filtration and the selection of products to control fluid condition are included in 561.

Recommended cleanliness levels, using petroleum oil under common conditions, are based on the highest fluid pressure levels in the system and are coded in the chart below. Fluids other than petroleum, severe service cycles, or temperature extremes are cause for adjustment of these cleanliness codes. See Vickers publication 561 for exact details.

Vickers products, as any components, will operate with apparent satisfaction in fluids with higher cleanliness codes than those described. Other manufacturers will often recommend levels above those specified. Experience has shown, however, that life of any hydraulic component is shortened in fluids with higher cleanliness codes than those listed below. These codes have been proven to provide a long, trouble-free service life for the products shown, regardless of the manufacturer.

Product	System Pressure Level bar (psi)		
	<70 (<1000)	70-207 (1000-3000)	207+ (3000+)
Directional Valves	20/18/15	20/18/15	19/17/14
Pressure/Flow Control Valves	19/17/14	19/17/14	19/17/14

Fluid Viscosity

16-51 cSt (575-250 SUS)

Fluids and Seals

Fluorocarbon seals are standard and are suitable for use with phosphate ester type fluids or their blends, water glycol, water-in-oil emulsion fluids and petroleum oil.
