

MPF SERIES

RETURN FILTER



MPFILTRI
filtri per oleodinamica



Maximum working pressure 3 bar

Flow rates to 750 l/min

D e s c r i p t i o n

MPF

MPF series filters are designed for return lines, and are installed semi-immersed in a reservoir.

Continued Research & Development on both the filter bodies and the filter elements has resulted in a product line with excellent pressure drop characteristics combined with a high filtration efficiency. The high flow rate bypass valves are a standard feature with this range of product.

MPF filters within this range are suitable for flow rates up to 750 l/min.

MPF filter series, are a 2,3 and 4 bolt fixing design

MPF series are specifically designed for use in mobile applications, agricultural machinery and power units.

New

absolute filter elements
independently tested
in the following Institutes:

Institute of Filtration
(France)



Royal Institute of Technology

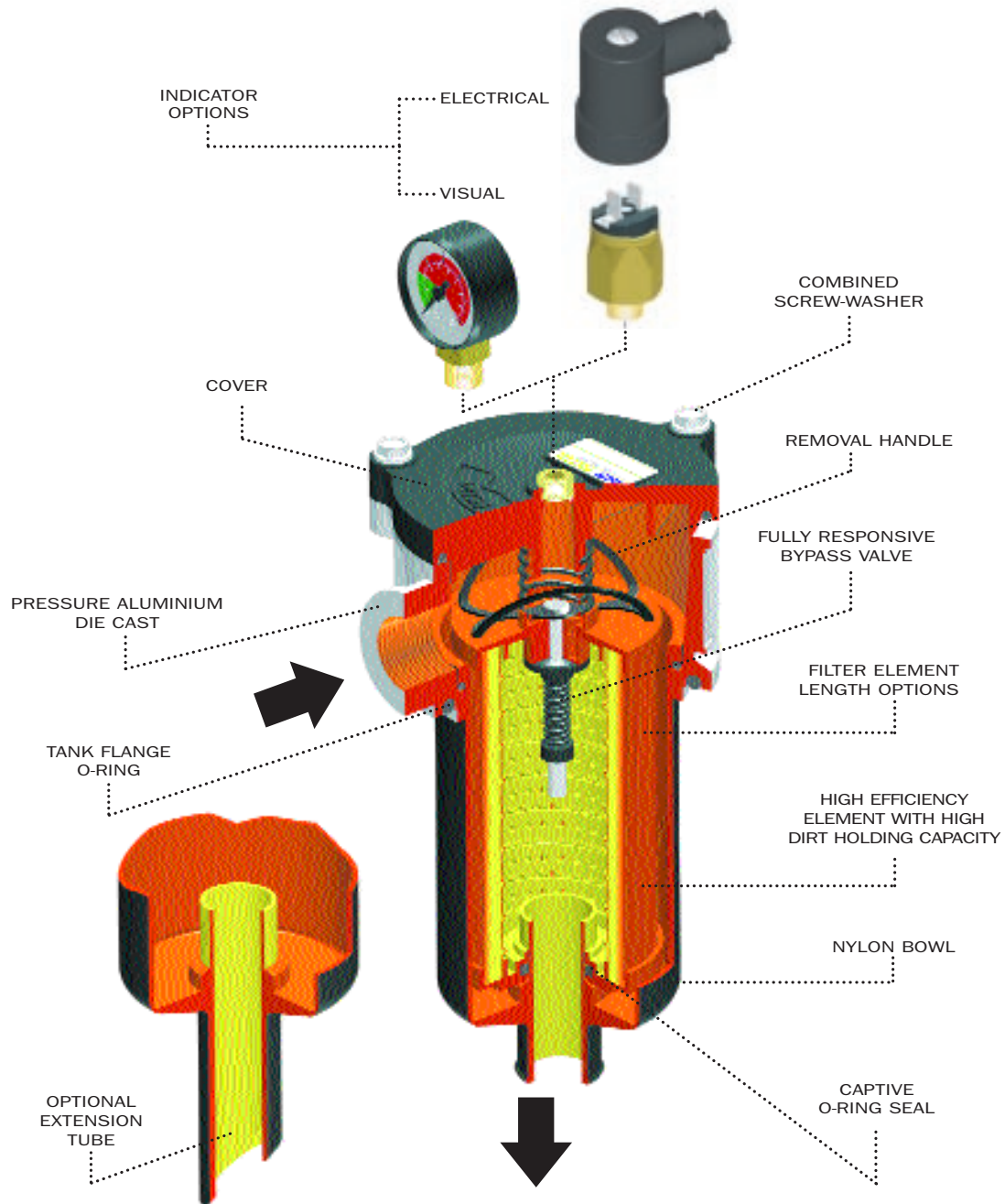

Filter element:

Materials

End caps:

Nylon

Support tube:

Galvanized steel

Support frames:

Coated wire mesh

A Series

Inorganic microfibre

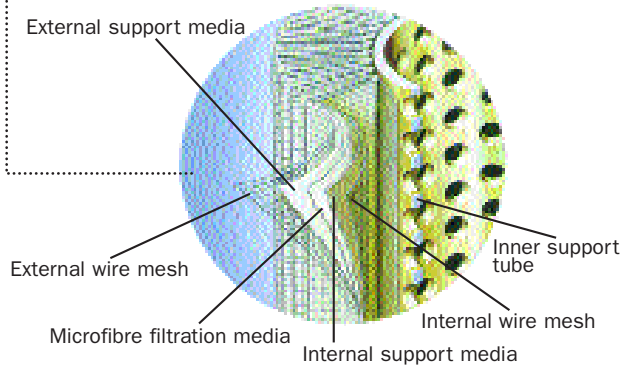

MP Filter elements - Conform to the following ISO standards

- ISO 2941 - Verification of collapse/burst resistance.
- ISO 2942 - Verification of fabrication integrity and determination of the first bubble point.
- ISO 2943 - Verification of material compatibility with fluids.
- ISO 3723 - Method for end load test.
- ISO 3724 - Verification of flow fatigue characteristics.
- ISO 3968 - Evaluation of pressure drop versus flow characteristics.
- ISO 4572 - Multi-pass method for evaluating filtration performance.

Element material Absolute filtration

A Series

Inorganic microfibre with acrylic support

Contamination retention

as per ISO 4572: Multi-pass test.

New improved $\beta \geq 200$ filter elements with greater efficiency and increased dirt holding capacity

Filter elements	Dimensions for β (μm) values				Filtration ratios			ΔP (bar)
	$\beta \geq 2$ (50%)	$\beta \geq 20$ (95%)	$\beta \geq 75$ (98,7%)	$\beta \geq 200$ (99,5%)	β_2	β_{10}	β_{20}	
A03	-	2	2,4	3	20	> 10.000	> 10.000	7
A06	-	3	4,6	6	8	> 2.000	> 10.000	7
A10	3	6	7,8	10	1,5	≥ 200	> 10.000	7
A25	13	19	22	25	-	> 1,5	> 35	7

N.B. Other materials giving different degrees of filtration are available on request.

Filtering area Filter elements H - ΔP 10 bar

Type MF	030-1	100-1	100-2	100-3	180-1	180-2	400-1	400-2	400-3	750-1
A03/A06	335	630	1000	1730	4300	7500	4740	6930	8760	11400
A10/A25	335	630	1000	1730	4300	7500	4740	6930	8760	11400

Values in cm^2

Element material Nominal filtration

P Series

Resin - impregnated paper

M Series

Square wire mesh (filtration degree is defined in microns by the maximum diameter of a sphere corresponding to the mesh size)

Filtering area Filter elements N - ΔP 3 bar

Type MF	030-1	100-1	100-2	100-3	180-1	180-2	400-1	400-2	400-3	750-1
P10/P25	410	1020	1660	1900	4000	8000	4480	6550	8280	13450
M25	290	460	730	1250	2000	4500	2410	3520	4450	7250
M60	290	460	730	1250	2000	4500	2000	3000	3840	6250
M90	290	460	730	1250	2000	4500	2000	3000	3840	5500

Values in cm^2

Filter body:

Materials

Head

Pressure die cast aluminium

Cover

MPF 030-100 Nylon
MPF 180-750 Aluminium

Bowl

Nylon - Steel (MPF 180-2/184-2 only)

Seals

A Series: Nitrile (Buna-N)
V Series: Viton

Bypass valve

Nylon

Indicator

Brass

Working

temperature

From -25 to +110°C
For temperatures outside this range, please consult our Sales Network Organization

Pressure filter

body

Maximum working pressure up to 3 bar
Test pressure: 5 bar
Minimum burst pressure: 10 bar

Fatigue test: a filter body subjected to pressure impulses from 0 to 3 bar will withstand 1.000.000 cycles

Collapse pressure

filter elements

N Series **3 bar**
H Series **10 bar**

Bypass valve

Calibration pressure

Bypass valve, differential opening pressure:

B: 1.75 bar ± 10%

Compatibility

with fluids

Filter head and bowls

compatible for use with:

- mineral oils (types HH-HL-HM-HR-HV-HG as per ISO 6743/4)
- water-based emulsions (types HFAE-HFAS as per ISO 6743/4)
- synthetic fluids (types HS-HFDR-HFDS-HFDU as per ISO 6743/4)
- water-glycol (types HFC as per ISO 6743/4)

Ask for anodized version

Filter elements

As per ISO 2943; suitable for mineral oils (types HH-HL-HM-HR-HV-HG as per ISO 6743/4) synthetic fluids (A and M series only) (types HS-HFDR-HFDS-HFDU as per ISO 6743/4)

For water-based emulsions (types HFAE-HFAS as per ISO 6743/4) and fluids other than those mentioned, please consult our Sales Network Organization.

Seals

A Series

Nitrile (Buna-N) compatible with mineral oils (types HH-HL-HM-HR-HV-HG as per ISO 6743/4)

water - based emulsions (types HFAE-HFAS as per ISO 6743/4)

water - glycol (types HFC as per ISO 6743/4)

V Series

Viton compatible with synthetic fluids (types HS-HFDR-HFDS-HFDU as per ISO 6743/4)

Types of indicators

Description:

MPF series filters are fitted with indicators switching at a pressure of

1.3 bar ± 10%

Visual indicator

V1 Series (bottom connection)

VR Series (rear connection) (**MPF 184, only**)

Colour coded pressure gauge scale 0÷6 bar

Electrical indicator

ER Series:

Pressure switch with N.O. contacts

EC Series:

Pressure switch with N.C. contacts

Operational information:

Max voltage: 48 Vac 50÷60 Hz

Max current: 0.5 A resistive, 0.2 A inductive.

Selection & installation information

Filter elements types

A Series

Absolute inorganic microfibre filtration media, available in 3, 6, 10 and 25 micron
Example - **A03, A06, A10** or **A25**

P Series

Nominal cellulose impregnated paper media, available in 10 and 25 micron.
Example - **P10** or **P25**

M Series

Metal mesh media, available in 25, 60, and 90 micron.
Example - **M25, M60** or **M90**.

Please refer to individual pressure drop curves to obtain filter assembly pressure drop information

The following filter sizing recommendations are based using a mineral oil fluid at 30 mm²/s (cSt) with a maximum total filter assembly (housing and filter element) pressure drop of 30% of the filter condition indicator (**0.4 bar**)

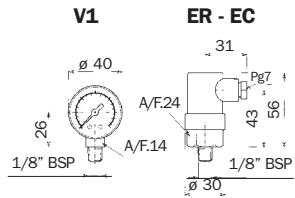
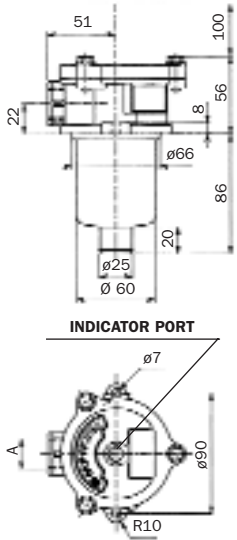

Housing pressure drop curve

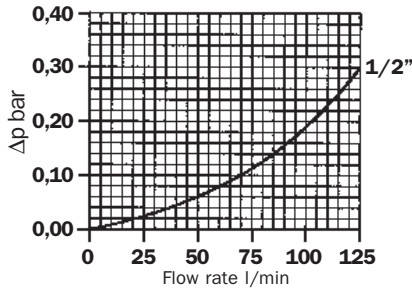

MPF 030

Holes on the tank

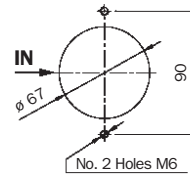

Thread connections

MPF SERIES 030 SIZE

Filter assembly	Flow rate l/min *	Bowl length	Port size BSP/NPT/SAE	Weight kg **
A03	10	1	1/2"	0,5
A06	12			
A10	24			
A25	35			
P10	33			

* Flow rates with 30 mm²/s fluid viscosity
** Weight including filter element

Type	A
G1	1/2" BSP
G4	1/2" NPT
G7	SAE 8 - 3/4" - 16 UNF

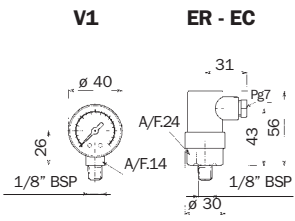
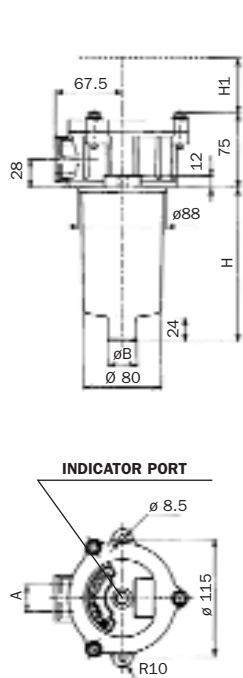

Housing pressure drop curve

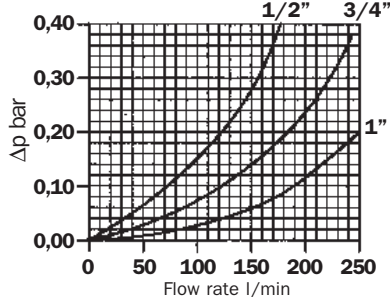

MPF 100

Holes on the tank

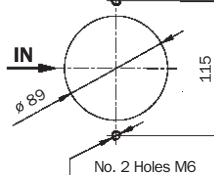

Thread connections

MPF SERIES 100 SIZE

Filter assembly	Flow rate l/min *	Bowl length	Port size BSP/NPT/SAE	Weight kg **
A03	28	1	1/2"	1,0
A06	33			
A10	35			
A25	75			
P10	55		3/4"	
A03	35	2	3/4"	1,2
A06	42			
A10	50			
A25	140			
P10	100		1"	
A03	45	3	3/4"	1,5
A06	55			
A10	75			
A25	170			
P10	125		1"	

* Flow rates with 30 mm²/s fluid viscosity
** Weight including filter element

Type	A
G1	1/2" BSP
G2	3/4" BSP
G3	1" BSP
G4	1/2" NPT
G5	3/4" NPT
G6	1" NPT
G7	SAE 8 - 3/4" - 16 UNF
G8	SAE 12 - 1 1/16" - 12 UN
G9	SAE 16 - 1 5/16" - 12 UN

Lengths

Type	H	H1	ø B
1	100	120	29
2	150	170	29
3	225	250	43

Selection & installation information

Please refer to individual pressure drop curves to obtain filter assembly pressure drop information

The following filter sizing recommendations are based using a mineral oil fluid at 30 mm²/s (cSt) with a maximum total filter assembly (housing and filter element) pressure drop of 30% of the filter condition indicator (0.4 bar)

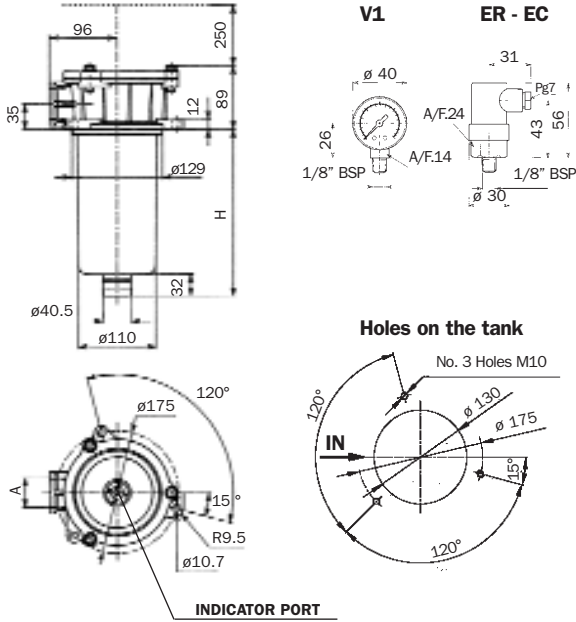

MPF 180

MPF SERIES 180 SIZE

Filter assembly	Flow rate l/min *	Bowl length	Port size BSP/NPT/SAE	Length H	Weight kg **
A03	100				
A06	120				
A10	150	1	1 1/4"	231	2,2
A25	300				
P10	190				
A03	210				
A06	270				
A10	320	2	1 1/4"	450	3,6
A25	360				
P10	345				

* Flow rates with 30 mm²/s fluid viscosity
 ** Weight including filter element

Thread connections

Type	A
G1	1 1/4" BSP
G4	1 1/4" NPT
G7	SAE 20 - 1 5/8" - 12 UN

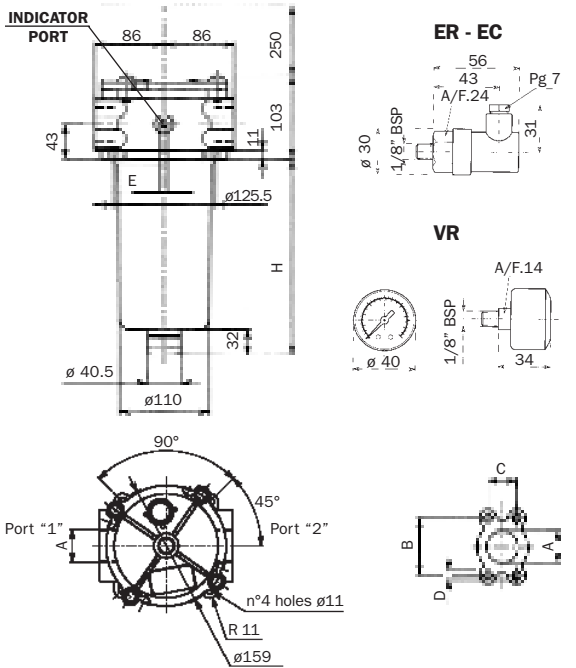

MPF 184

MPF SERIES 184 SIZE

Filter assembly	Flow rate l/min *	Bowl length	Port size BSP/NPT/SAE	Length H	Weight kg **
A03	100				
A06	120				
A10	150	1	1 1/4"	230	2,5
A25	300				
P10	190				
A03	210				
A06	270				
A10	320	2	1 1/4"	449	3,9
A25	360				
P10	345				

Dual port option availables - See ordering information
 Flange port option availables - See ordering information
 * Flow rates with 30 mm²/s fluid viscosity
 ** Weight including filter element

Thread connections

Type	A	E
G1	1 1/4" BSP	1/8" BSP
G2	2 Ports 1 1/4" BSP	1/8" BSP
G4	1 1/4" NPT	1/8" NPT
G5	2 Ports 1 1/4" NPT	1/8" NPT
G7	SAE 20 - 1 5/8" - 12 UN	1/8" NPT
G8	2 Ports SAE 20 - 1 5/8" - 12 UN	1/8" NPT

Flange connections

Type	A	B	C	D	E
F1	1 1/2" SAE 3000 PSI/M	69,85	35,71	M12	1/8" BSP
F2	1 1/2" SAE 3000 PSI/UNC	69,85	35,71	1/2" UNC	1/8" NPT
F3	2 Ports 1 1/2" SAE 3000 PSI/M	69,85	35,71	M12	1/8" BSP
F4	2 Ports 1 1/2" SAE 3000 PSI/UNC	69,85	35,71	1/2" UNC	1/8" NPT

MPF 180 & 184
Housing pressure drop curve

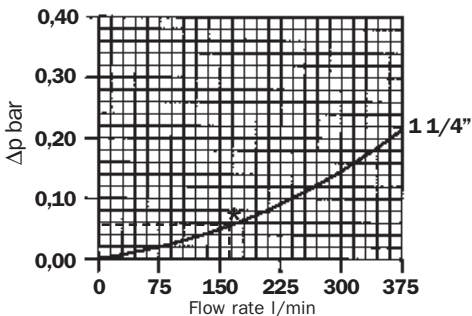

Selection & installation information

Please refer to individual pressure drop curves to obtain filter assembly pressure drop information

The following filter sizing recommendations are based using a mineral oil fluid at 30 mm²/s (cSt) with a maximum total filter assembly (housing and filter element) pressure drop of 30% of the filter condition indicator (**0.4 bar**)

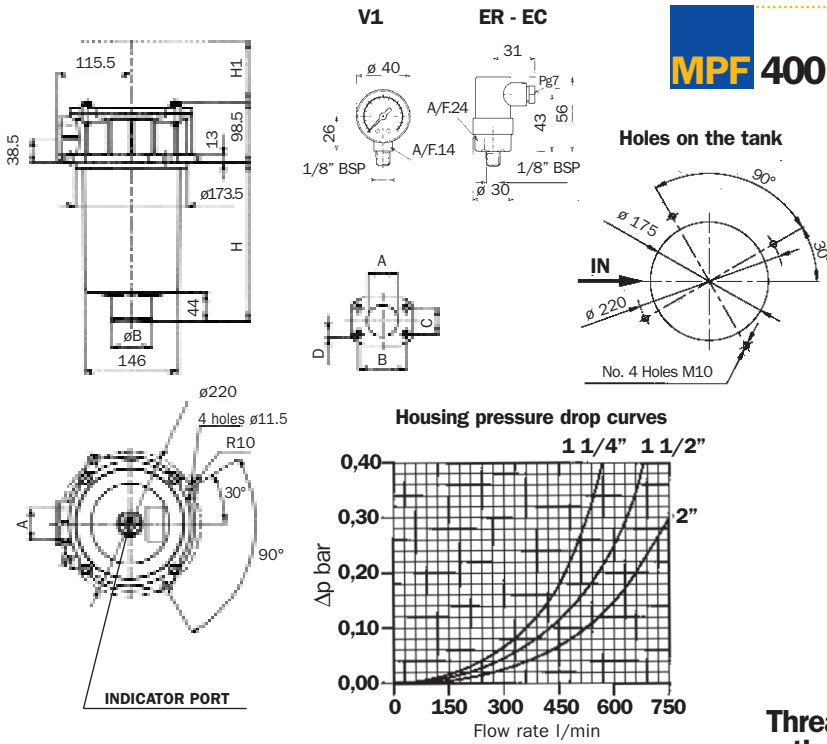

MPF SERIES 400 SIZE

Filter assembly	Flow rate l/min *	Bowl length	Port size BSP/NPT/SAE	Weight kg **
A03	120	1	1 1/4"	3,0
A06	150			
A10	170		1 1/2"	
A25	340			
P10	280	2	2"	3,5
A03	170			
A06	200			
A10	260	3	2"	3,7
A25	450			
P10	320			
A03	220			
A06	270			
A10	320			
A25	500			
P10	420			

* Flow rates with 30 mm²/s fluid viscosity
 ** Weight including filter element

Thread connections

Type	A
G1	1 1/4" BSP
G2	1 1/2" BSP
G3	2" BSP
G4	1 1/4" NPT
G5	1 1/2" NPT
G6	2" NPT
G7	SAE 20 - 1 5/8" - 12 UN
G8	SAE 24 - 1 7/8" - 12 UN
G9	SAE 32 - 2 1/2" - 12 UN

Lengths

Type	H	H1	ø B
1	178	200	51
2	238	250	64
3	288	310	64

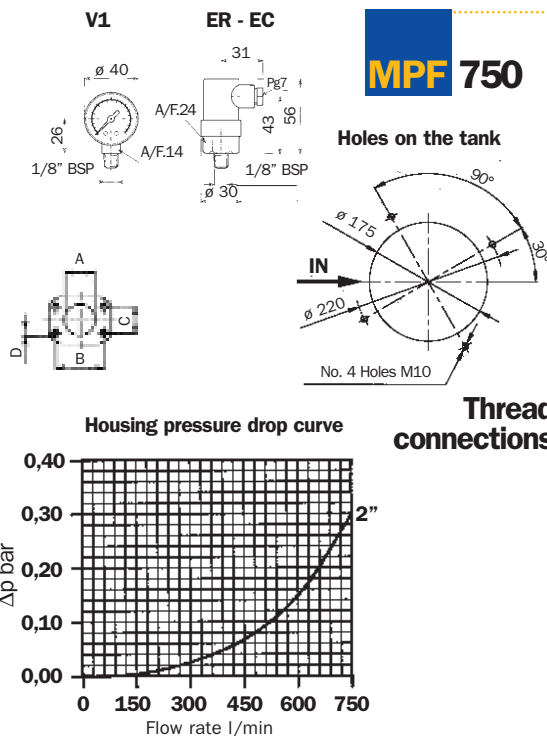

MPF SERIES 750 SIZE

Filter assembly	Flow rate l/min *	Bowl length	Port size BSP/NPT/SAE	Weight kg **
A03	250	1	2"	7,0
A06	300			
A10	400			
A25	575			
P10	440			

* Flow rates with 30 mm²/s fluid viscosity
 ** Weight including filter element

Thread connections

Type	A
G1	2" BSP
G4	2" NPT
G7	SAE 32 - 2 1/2" - 12 UN

Flange connections

Type	A	B	C	D
F1	2" SAE 3000 PSI/M	77,77	42,88	M12
F2	2" SAE 3000 PSI/UNC	77,77	42,88	1/2" UNC

Pressure drop information

General

Pressure drop versus flow rate curve information for both housing and filter elements is in accordance with ISO 3968

Filter assembly pressure drop - $\Delta p_{\text{Total}} = \Delta p_{\text{Housing}} + \Delta p_{\text{Filter element}}$

Housing pressure drop - The housing pressure drop is proportional to the fluid density

Filter element pressure drop - Filter element pressure drop is proportional to kinematic viscosity therefore always check the fluid operating temperature and fluid type to obtain the working viscosity according to the following formula:

$$\Delta p_1 \text{ Filter element} = (\text{working viscosity} / \text{brochure viscosity}) \times \Delta p \text{ filter element}$$

Brochure viscosity 30 mm²/s (cSt)

Filter assembly sizing example

- Customer requires a 160 l/min filter assembly
- Mineral oil fluid: ISO VG 68 (68 mm²/s (cSt) at 40°C)
- A25 - 25 micron absolute filtration

Selection :

- **Housing pressure drop** - MPF 180 - 184 with 160 l/min $\Delta p = 0.06$ bar (see curve on page 6)
- **Filter element pressure drop** (brochure viscosity) - MF 180.1.A25HB with 160 l/min $\Delta p = 0.13$ bar (see curve on page 9)
- **Filter element pressure drop** (working viscosity) - With 68 mm²/s (cSt) $\Delta p_1 = 0.13 \times (68/30) = 0.30$ bar
- **Filter assembly pressure drop** $\Delta p_{\text{Total}} = \Delta p_{\text{Housing}} + \Delta p_1 \text{ Filter element} = 0.06 + 0,30 = \mathbf{0,36 \text{ bar}^*}$ { Acceptable pressure drop value, as per our recommendations

Bypass valves pressure drop

The curves were obtained using a mineral oil with a density of 0,86 kg/dm³.
The Δp varies proportionally to the density.

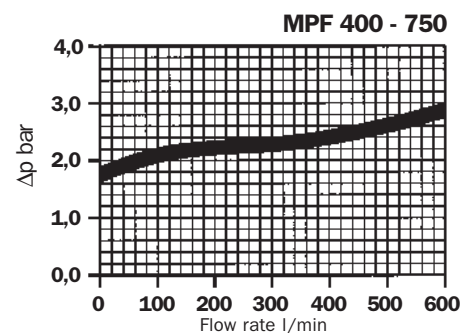
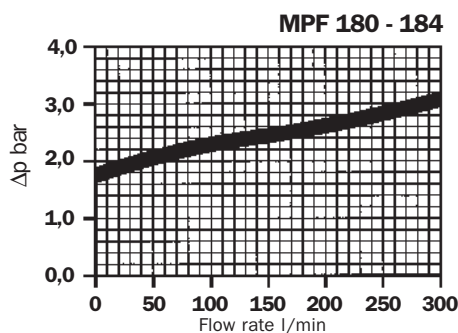
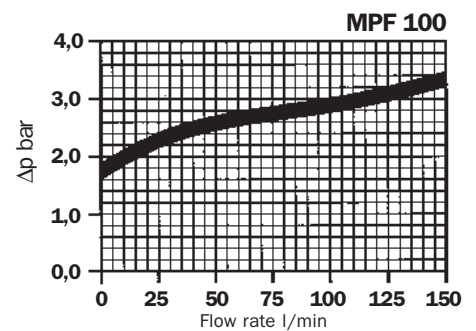
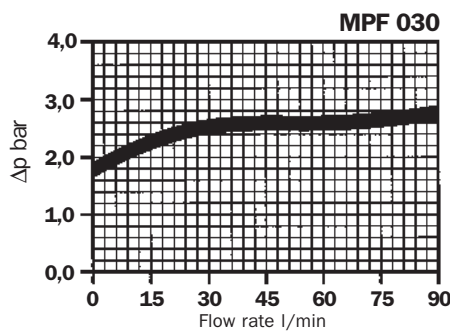

Filter elements - N - ΔP 3bar

The curves were obtained using a mineral oil with a kinematic viscosity of 30 mm²/s (cSt).
The Δp varies proportionally to the fluid kinematic viscosity.

For the metal mesh filter elements curves (M series), please consult our Sales and Network Organization

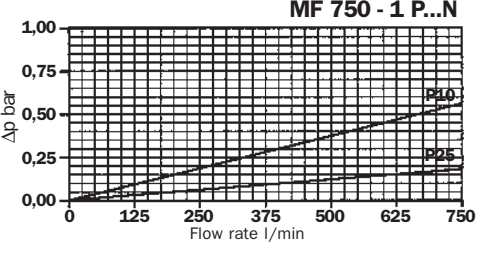
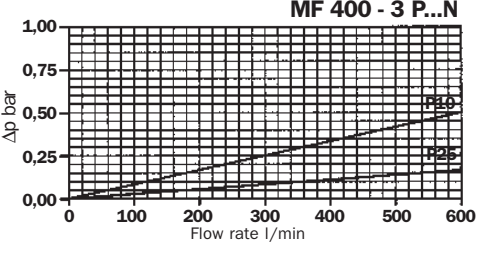
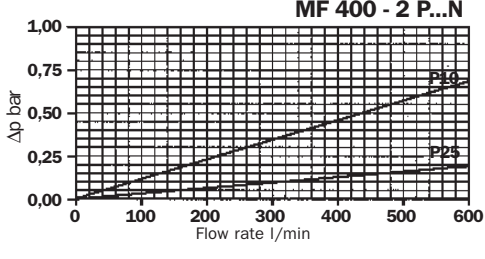
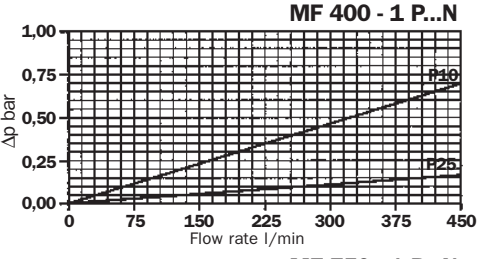
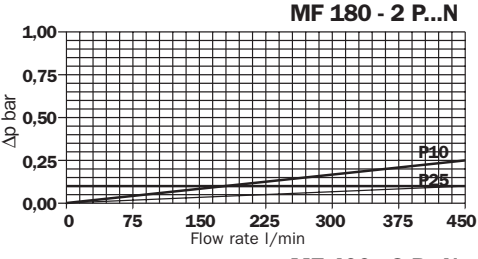
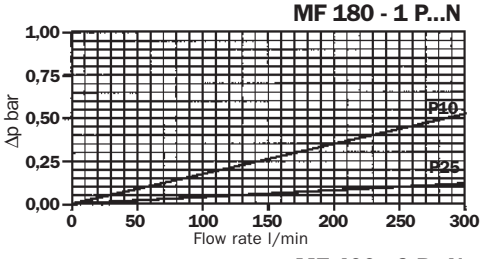
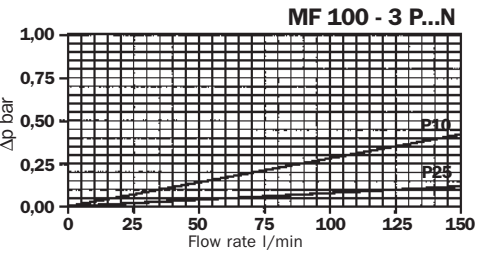
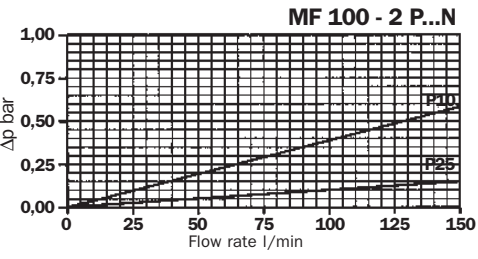
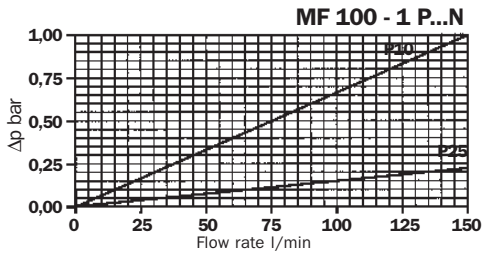
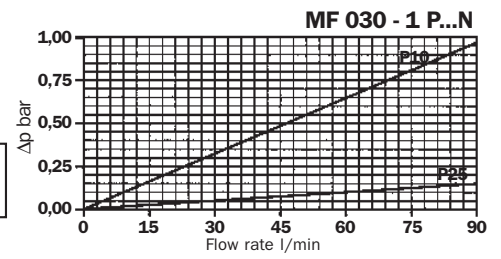

Filter elements - H - ΔP 10bar

The curves were obtained using a mineral oil with a kinematic viscosity of 30 mm² /s (cSt).
The Δp varies proportionally to the fluid kinematic viscosity.

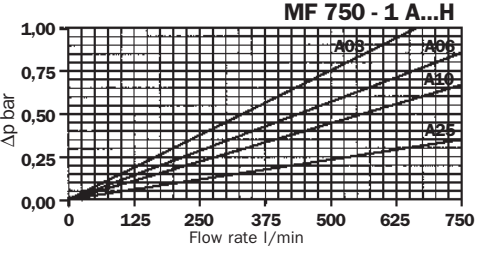
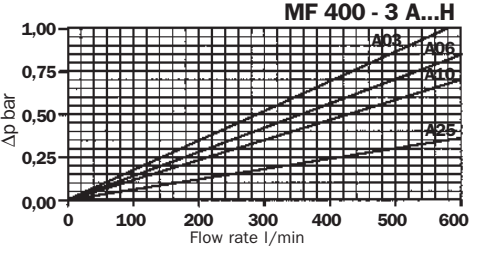
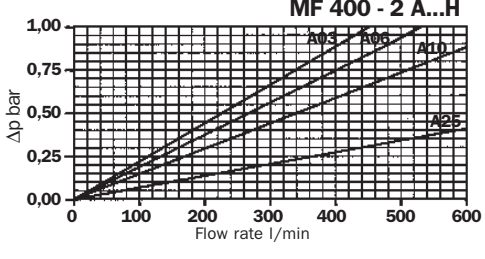
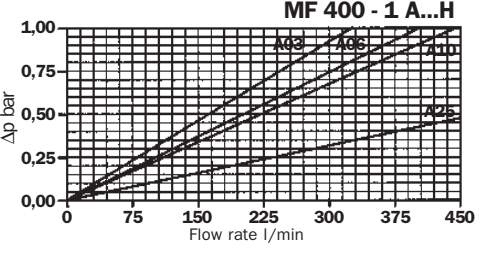
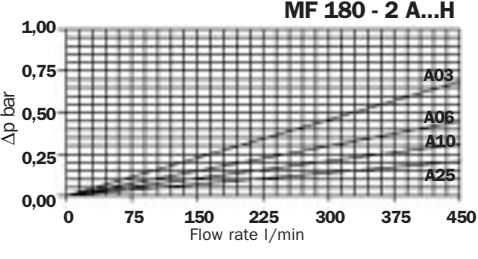
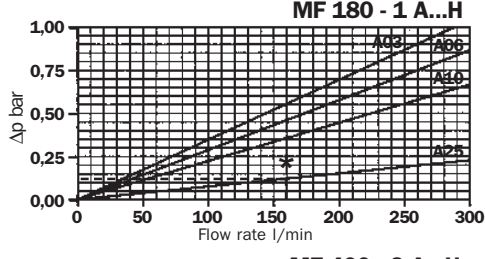
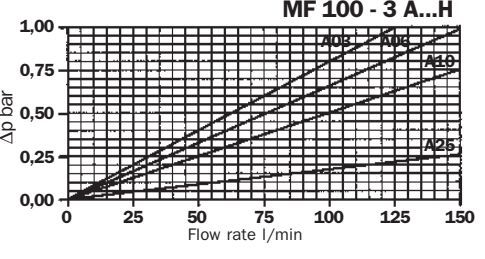
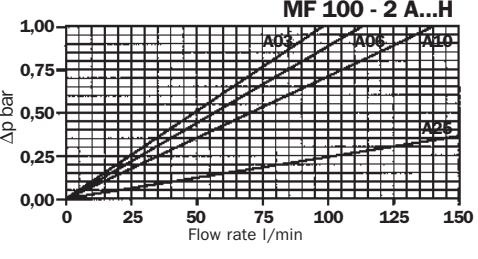
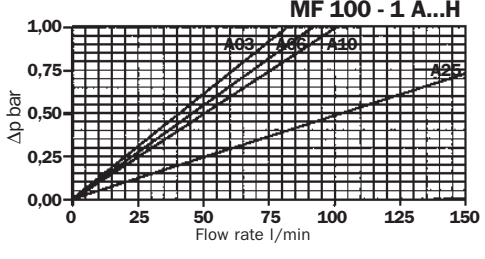
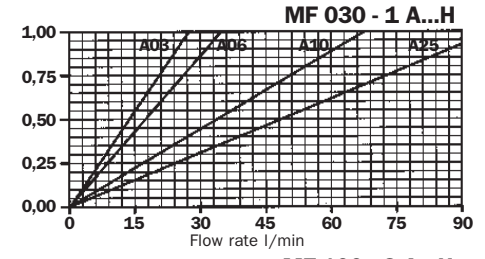

*Example: See page 8

Filter element replacement

The filter element has a handle on the top allowing easy removal of itself from the bowl.

The helical spring is utilized to secure the filter element in its location.

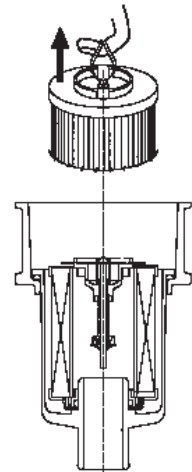

Special application filters on request

Extension tube:

Ordering code and length

CODE XX	LENGTH "H" in mm.
10	100
11	110
12	120
...	...
99	990

NOTES:

- When extension tube is ordered, indicator must be ordered separately
- Extension tube lengths have variable sizes multiple of 10 mm.

Example: length H = 300 mm. Visual indicator.

Filter code: MPF 100 1 - AG1 A10HB/30 – **Indicator code:** V1

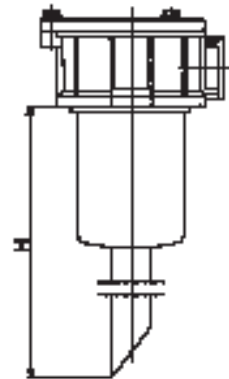

Filler plug:

Please note, when the T5 option is required, fill the ordering code with H or K instead of G or F port option (see the example below). Indicator option is not available when the filler plug is fitted (except for MPF 184).

Ordering code:

(See page 11) T5

Example: MPF 030 1 A H1 A10 HB/T5

MPF 750 1 A K1 A10 HB/T5

Filler plug.

Thread M 30x1,5

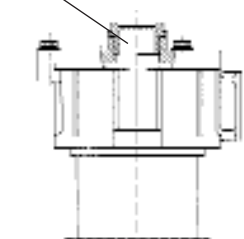

Applications

Example of application

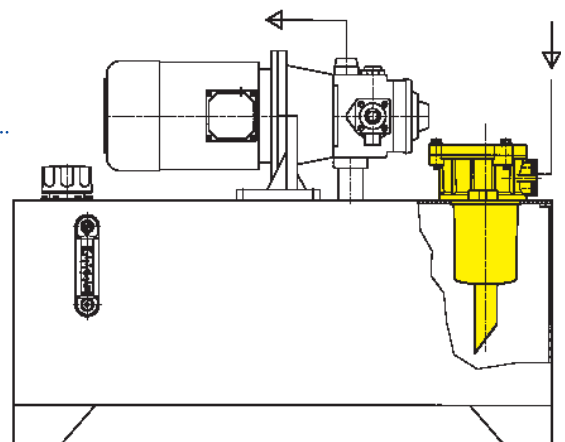

Ordering information

MPF

Nominal sizes

030
100
180
184 (use MF 180 filter element code)
400
750

Bowl lengths

MPF 030 = 1
MPF 100 = 1,2,3
MPF 180-184 = 1,2
MPF 400 = 1,2,3
MPF 750 = 1

Seals

A Nitrile (Buna-N)
V Viton

Ports option

Type	MPF 030	MPF 100	MPF 180	MPF 184	MPF 400	MPF 750
G1	1/2" BSP	1/2" BSP	1 1/4" BSP	1 1/4" BSP	1 1/4" BSP	2" BSP
G2	-	3/4" BSP	-	2 Ports 1 1/4" BSP	1 1/2" BSP	-
G3	-	1" BSP	-	-	2" BSP	-
G4	1/2" NPT	1/2" NPT	1 1/4" NPT	1 1/4" NPT	1 1/4" NPT	2" NPT
G5	-	3/4" NPT	-	2 Ports 1 1/4" NPT	1 1/2" NPT	-
G6	-	1" NPT	-	-	2" NPT	-
G7	SAE 8	SAE 8	SAE 20	SAE 20	SAE 20	SAE 32
G8	-	SAE 12	-	2 Ports SAE 20	SAE 24	-
G9	-	SAE 16	-	-	SAE 32	-
F1	-	-	-	1 1/2" SAE 3000 PSI/M	-	2 SAE 3000 PSI/M
F2	-	-	-	1 1/2" SAE 3000 PSI/UNC	-	2 SAE 3000 PSI/UNC
F3	-	-	-	2x1 1/2" SAE 3000 PSI/M	-	-
F4	-	-	-	2x1 1/2" SAE 3000 PSI/UNC	-	-

Filter condition indicator

T With plug (std)
V1 Visual
VR Visual (MPF 184 Series only)
ER Electrical: N.O. contacts
EC Electrical: N.C. contacts
T5 Filler plug (see page 10)
XX Extension tube (see page 10)

Bypass valve

B Bypass 1.75 bar

Seals (Filter elements)

B Nitrile (Buna - N)
V Viton

Collapse pressure series

N 3 bar (P/M series)
H 10 bar (A series, only)

Filter elements N series

P10
P25 Resin-impregnated paper Bx ≥ 2
M25
M60 Square wire mesh
M90

Filter elements H series

A03
A06
A10
A25 Inorganic microfibre Bx ≥ 200

MF

Replacement element

MP Filtri - Filtration products will only be guaranteed if original MP Filtri replacement elements and spares are used

Data held in this publication is given only for indicative purposes. MP Filtri reserves to introduce modifications to describe items for technical or commercial reasons. Copyright reserved.

**Head Quarter :****MP FILTRI S.p.A. Italy**

Via Matteotti, 2
20060 Pessano con Bornago (Milano) Italy
Tel. ++39.02/95703.1
Fax ++39.02/95741497-95740188
email: sales@mpfiltri.com
<http://www.mpfiltri.com>

**GREAT BRITAIN****MP FILTRI U.K. Ltd.**

Bourton Industrial Park
Bourton on the Water
Gloucestershire GL54 2HQ UK
Phone: 01451-822522
Fax: 01451-822282
email: sales@mpfiltri.co.uk
<http://www.mpfiltri.co.uk>

GERMANY**MP FILTRI D GmbH**

Am Wasserturm 5
D-66265 Heusweiler/Holz
Phone: 06806/85022-0
Fax: 06806/85022-18
email: mpfiltrink@aol.com

FRANCE**MP FILTRI FRANCE**

B.P. 325
01603 Trevoux Cedex
Tel: 04.74.08.84.78
Telefax: 04.74.08.80.45
email: mpfiltrifrance@wanadoo.fr

USA**MP FILTRI USA Inc.**

2055 Quaker Pointe Drive
Quakertown, PA 18951
Phone: 215-529-1300
Fax: 215-529-1902
email: mpusasales@aol.com
<http://www.mpfiltriusa.com>

CANADA**MP FILTRI CANADA Inc.**

210 Jacob Keffer Parkway Concord,
Ontario Canada L4K 4W3
Phone: 905-303-1369
Fax: 905-303-7256
email: mail@mpfiltricanada.com
<http://www.mpfiltricanada.com>