

## Pressure sensors SPAN

# FESTO



Festo Core Range  
Solves the majority of your automation tasks

Worldwide: Quickest delivery – wherever, whenever  
Simply good: Expected high Festo quality  
Fast: Easy and fast to select

With the Festo Core Range, we have selected the most important products and functions from our broad product catalogue, and added the quickest delivery.

The Core Range offers you the best value for your automation tasks.

Just look  
for the  
star!

## Key features

### At a glance

#### Communication interface



#### Practical design

- Compact design 30x30 mm
- Degree of protection IP40
- Weight reduction with QS4

#### Universal pressure measurement

- Pressure and vacuum
- 14 pressure measuring ranges
- All standard pressure units
- Optional test report



#### Easy operation

- Clear display
- Configurable red surround for the entire display
- Intuitive menu navigation

#### Quick installation

- L1 plug for fast commissioning
- M8 electrical adapters allow maximum flexibility
- Wide range of mounting options
- QS4 quick connector

#### Switchable electrical outputs

- Various switching functions
- Switching outputs (PNP/NPN, NO/NC)
- Analogue outputs (0 ... 10 V, 1 ... 5 V, 4 ... 20 mA)

#### Product description

The pressure sensor SPAN is suitable for monitoring compressed air and non-corrosive gases. The sensor can be used in many industries thanks to its compact design. The measuring method is based on a piezoresistive measuring cell for relative pressure measurement. The pressure value is transmitted to the connected controller as a switching signal, as an analogue signal or via IO-Link depending on the sensor variant and selected parameters.

#### Area of application

- Network monitoring (pressure present)
- Regulator monitoring (pressure in the setpoint range)
- Vacuum (part picked up)
- Leak test (pressure drop over time)
- Object detection (back pressure present)

#### Functions

- Monitoring and setting a pressure threshold, a pressure range or differential pressure monitoring with teach-in function or by entering values
- ECO function with option to switch off the display
- Optional security code can be freely chosen (4-digit code)
- Adjustable low-pass filter to smooth the pressure signal
- Scaling the analogue output to increase the signal dynamics
- Offset compensation possible
- Min./max. value memory for monitoring compressed air
- All settings that have been carried out on one sensor (master) can be transferred (replication) to identical sensors (device)

#### Variants with IO-Link

- Serial communication integrated using IO-Link 1.1
- Cyclical transfer of two operating statuses and the measured pressure value
- The sensor can be parameterised remotely using an IO-Link master
- Sensor can be changed easily using automatic parameterisation (hot swap)
- Sensor identification, diagnostics and teach-in via IO-Link possible

#### 2-step connection

- [1] Push in L1 plug
- [2] Push in tubing

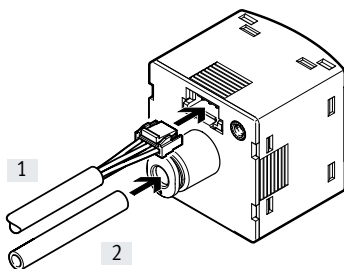

## Key features

### Mounting options

Front panel mounting



Manifold mounting with mounting bracket

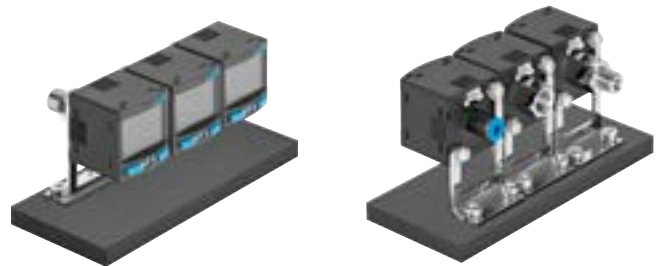

Threaded mounting with M8 adapter



Wall mounting

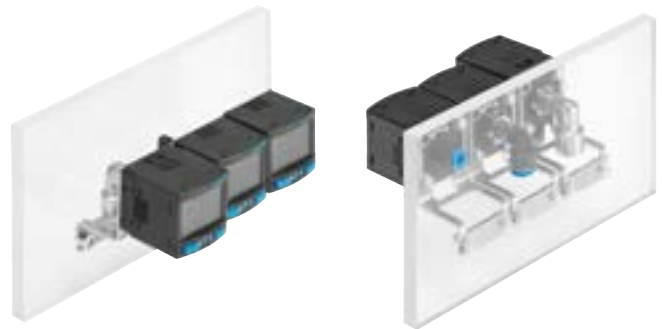

### Ordering data – Product options

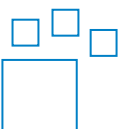

Configurable product  
This product and all its product options can be ordered using the configurator.

The configurator can be found under  
Products on the DVD or at  
→ [www.festo.com/catalogue/...](http://www.festo.com/catalogue/...)

| Part no. | Type |
|----------|------|
| 8003300  | SPAN |

Product range overview

|                                 |               | <b>Basic variant</b><br>SPAN-B-...-PN-...              | <b>Standard variant<br/>Switch</b><br>SPAN-...-PN-PN-... | <b>Standard variant<br/>IO-Link/analogue output</b><br>SPAN-...-PNLK-PNVBA-... |
|---------------------------------|---------------|--|--|--|
| Pressure range                  |               | V1R, B2R, B11R   | V1R, P10, B2R, B11R                                      | All possible, see type codes for pressure measuring range                      |
| Switching output                |               | 1  | 2  | 2  |
| Analogue output                 |               | -  | -  | Yes  |
| IO-Link                         |               | -  | -  | Yes  |
| Displayable units               |               | 6  | 9  | 9  |
| Auto difference Monitoring      |               | -  | Yes  | Yes  |
| Pressure supply port            | G18M/<br>R18M | Nickel-plated brass, short<br>Without M5 female thread | Stainless steel, long<br>With M5 female thread           | Stainless steel, long<br>With M5 female thread                                 |
|                                 | N18M-         | -  | Stainless steel, long<br>With M5 female thread           | Stainless steel, long<br>With M5 female thread                                 |
|                                 | G18F-         | Polymer  | Stainless steel  | Stainless steel  |
|                                 | M5F           | Aluminium  | Stainless steel  | Stainless steel  |
|                                 | QS4-          | Polymer/stainless steel                                | Polymer/brass  | Polymer/brass  |
| Mounting thread for Accessories |               | Polymer  | Stainless steel  | Stainless steel  |
| Test report                     |               | -  | Yes  | Yes  |

Peripherals overview

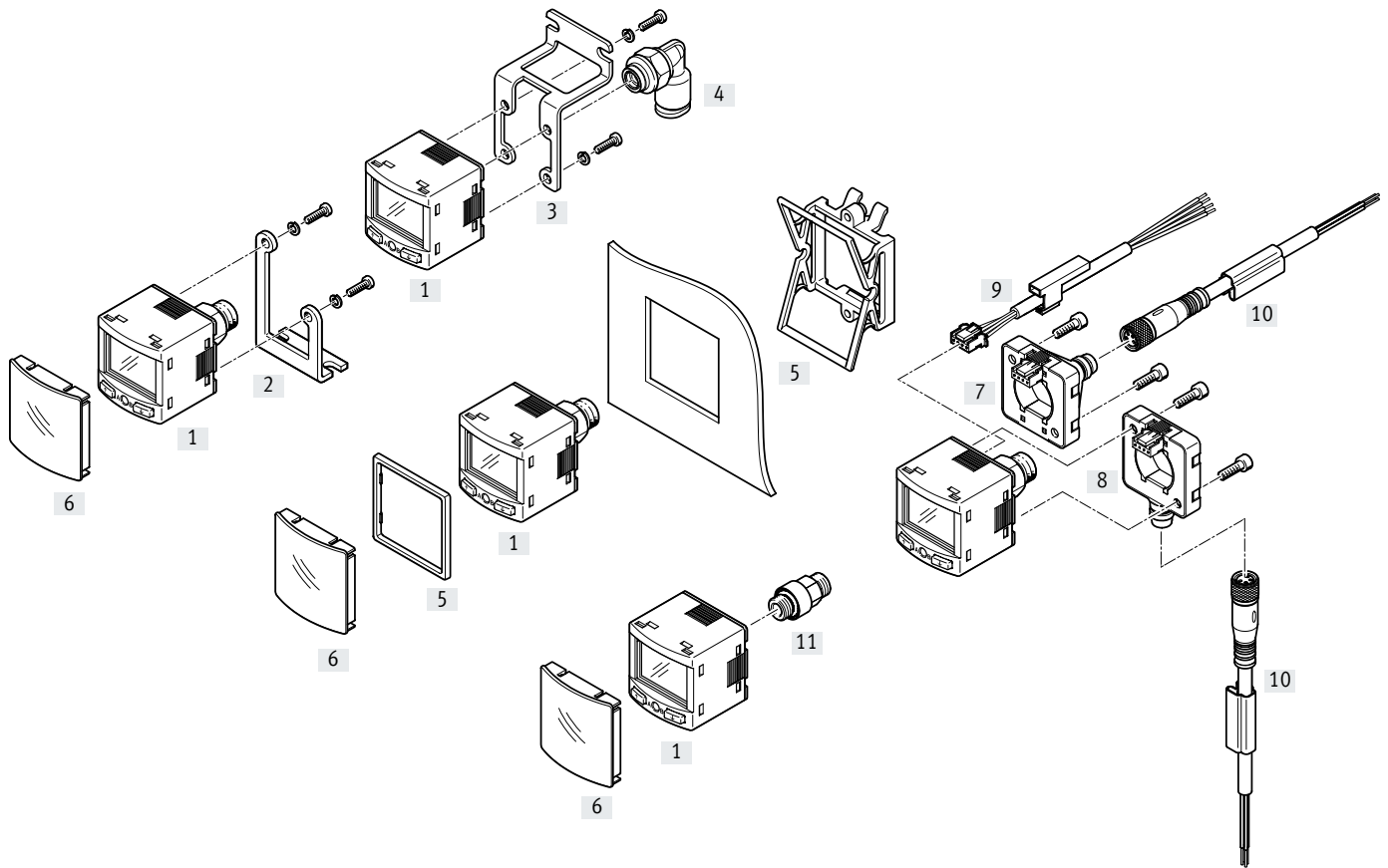

| Accessories |                                   | → Page | Accessories |  | → Page |
|-------------|-----------------------------------|--------|-------------|--|--------|
| [1]         | Pressure sensors<br>SPAN-/SPAN-B- | 7      | [7]         | Electrical adapter<br>SASC-P4-A-M8-S                             | 17     |
| [2]         | Mounting bracket<br>SAMH-PU-A     | 15     | [8]         | Electrical adapter<br>SASC-P4-A-M8-A                             | 17     |
| [3]         | Wall mounting<br>SAMH-PN-W        | 15     | [9]         | Connecting cable<br>NEBS-L1G4                                    | 19     |
| [4]         | Push-in fitting<br>QSML-M5        | 19     | [10]        | Connecting cable<br>NEBU-M8                                      | 19     |
| [5]         | Panel mounting kit<br>SAMH-PN-F   | 16     | [11]        | Adapter (for -G18FPM- with electrical adapter)<br>SASA-PN-A-MG18 | 18     |
| [6]         | Safety guard<br>SACC-PN-G         | 16     |             |  |        |

## Type codes

|             |                 |
|-------------|-----------------|
| <b>001</b>  | <b>Series</b>   |
| <b>SPAN</b> | Pressure sensor |

|            |                        |
|------------|------------------------|
| <b>002</b> | <b>Product version</b> |
|            | Standard               |
| <b>B</b>   | Basic                  |

|             |                                 |
|-------------|---------------------------------|
| <b>003</b>  | <b>Pressure measuring range</b> |
| <b>B2</b>   | -1 ... 1 bar                    |
| <b>B02</b>  | -0.1 ... 0.1 bar                |
| <b>B11</b>  | -1 ... 10 bar                   |
| <b>P025</b> | 0 ... 0.25 bar                  |
| <b>P05</b>  | 0 ... 0.5 bar                   |
| <b>P1</b>   | 0 ... 1 bar                     |
| <b>P2</b>   | 0 ... 2 bar                     |
| <b>P6</b>   | 0 ... 6 bar                     |
| <b>P10</b>  | 0 ... 10 bar                    |
| <b>P12</b>  | 0 ... 12 bar                    |
| <b>P16</b>  | 0 ... 16 bar                    |
| <b>V025</b> | 0 ... -0.25 bar                 |
| <b>V05</b>  | 0 ... -0.5 bar                  |
| <b>V1</b>   | 0 ... -1 bar                    |

|            |                       |
|------------|-----------------------|
| <b>004</b> | <b>Pressure inlet</b> |
| <b>R</b>   | Relative pressure     |

|            |                             |
|------------|-----------------------------|
| <b>005</b> | <b>Pneumatic connection</b> |
| <b>G18</b> | G1/8                        |
| <b>R18</b> | R1/8                        |
| <b>N18</b> | 1/8 NPT                     |
| <b>M5</b>  | M5                          |
| <b>Q4</b>  | Push-in connector 4 mm      |

|            |                    |
|------------|--------------------|
| <b>006</b> | <b>Thread type</b> |
|            | None               |
| <b>F</b>   | Female             |
| <b>M</b>   | Male               |

|            |                        |
|------------|------------------------|
| <b>007</b> | <b>Thread material</b> |
|            | Standard               |
| <b>AL</b>  | Aluminium              |
| <b>PM</b>  | Polymer                |

|             |                            |
|-------------|----------------------------|
| <b>008</b>  | <b>Electrical output 1</b> |
| <b>PN</b>   | PNP/NPN                    |
| <b>PNLK</b> | PNP/NPN/IO-Link            |

|              |  |
|--------------|--|
| <b>009</b>   | <b>Electrical output 2</b>                           |
|              | None   |
| <b>PN</b>    | PNP or NPN   |
| <b>PNVBA</b> | PNP or NPN or 0 ... 10 V or 1 ... 5 V or 4 ... 20 mA |

|            |                              |
|------------|------------------------------|
| <b>010</b> | <b>Electrical connection</b> |
| <b>L1</b>  | Plug type L1                 |

|            |                             |
|------------|-----------------------------|
| <b>011</b> | <b>Mounting accessories</b> |
|            | None                        |
| <b>A</b>   | Mounting bracket            |
| <b>W</b>   | Wall mounting               |
| <b>FP</b>  | Front panel mounting kit    |

|            |                              |
|------------|------------------------------|
| <b>012</b> | <b>Electrical adapter</b>    |
|            | None                         |
| <b>EA</b>  | Electrical adapter, angled   |
| <b>ES</b>  | Electrical adapter, straight |

|             |                               |
|-------------|-------------------------------|
| <b>013</b>  | <b>Electrical accessories</b> |
|             | None                          |
| <b>5S</b>   | Straight socket, cable 5 m    |
| <b>2.5S</b> | Straight socket, cable 2.5 m  |
| <b>5A</b>   | Angled socket, cable 5 m      |
| <b>2.5A</b> | Angled socket, cable 2.5 m    |

|            |                           |
|------------|---------------------------|
| <b>014</b> | <b>Protective devices</b> |
|            | None                      |
| <b>G</b>   | Protective hood           |

|            |                    |
|------------|--------------------|
| <b>015</b> | <b>Certificate</b> |
|            | None               |
| <b>T</b>   | Test report        |

## Data sheet

Variant with IO-Link and analogue outputs ... -PNLK-PNVBA

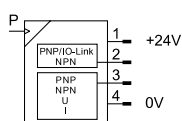

Variant with 2 switching outputs ... -PN-PN

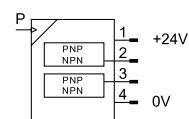

Variant with 1 switching output ... -B-...-PN

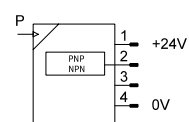

- Compact design 30x30
- 14 pressure measuring ranges  
-1 ... +16 bar available
- Voltage 12/24 V DC
- Temperature range 0 ... +50°C
- Degree of protection IP40



### General technical data

|  |   |
|--|---|
| Certification                              | RCM<br>c UL us - Listed (OL) <sup>1)</sup>  |
| Certificate issuing authority              | UL E322346                                  |
| CE marking (see declaration of conformity) | To EU EMC Directive<br>To EU RoHS Directive |
| KC mark                                    | KC EMC                                      |
| PWIS conformity                            | VDMA24364-B1/B2-L                           |
| Note on materials                          | RoHS-compliant                              |

1) Not valid for SPAN-B

| Input signal, measuring element      |       | -B02                                      | -B2   | -B11  | -V025  | -V05  | -V1   | -P025 | -P05 | -P1  | -P2 | -P6   | -P10  | -P12  | P16 |
|--------------------------------------|-------|---|-------|-------|--------|-------|-------|-------|------|------|-----|-------|-------|-------|-----|
| Measured variable                    |       | Relative pressure                         |       |       |        |       |       |       |      |      |     |       |       |       |     |
| Measurement method                   |       | Piezoresistive pressure sensor            |       |       |        |       |       |       |      |      |     |       |       |       |     |
| Pressure measuring range start value | [MPa] | -0.01                                     | -0.1  | -0.1  | 0      |       |       |       |      |      |     |       |       |       |     |
|                                      | [bar] | -0.1                                      | -1    | -1    | 0      |       |       |       |      |      |     |       |       |       |     |
|                                      | [psi] | -1.45                                     | -14.5 | -14.5 | 0      |       |       |       |      |      |     |       |       |       |     |
| Pressure measuring range end value   | [MPa] | 0.01                                      | 0.1   | 1     | -0.025 | -0.05 | -0.1  | 0.025 | 0.05 | 0.1  | 0.2 | 0.6   | 1     | 1.2   | 1.6 |
|                                      | [bar] | 0.1                                       | 1     | 10    | -0.25  | -0.5  | -1    | 0.25  | 0.5  | 1    | 2   | 6     | 10    | 12    | 16  |
|                                      | [psi] | 1.45                                      | 14.5  | 145   | -3.62  | -7.25 | -14.5 | 3.62  | 7.25 | 14.5 | 29  | 87    | 145   | 174   | 232 |
| Max. overload pressure               | [MPa] | 0.1                                       | 0.5   | 1.5   | 0.1    | 0.2   | 0.5   | 0.1   | 0.2  | 0.5  | 0.6 | 1.5   | 1.5   | 1.5   | 2.0 |
|                                      | [bar] | 1   | 5     | 15    | 1      | 2     | 5     | 1     | 2    | 5    | 6   | 15    | 15    | 15    | 20  |
|                                      | [psi] | 14.5                                      | 72.5  | 217.5 | 14.5   | 29    | 72.5  | 14.5  | 29   | 72.5 | 87  | 217.5 | 217.5 | 217.5 | 290 |
| Operating medium                     |       | Compressed air to ISO 8573-1:2010 [7:4:4] |       |       |        |       |       |       |      |      |     |       |       |       |     |
|                                      |       | Inert gases                               |       |       |        |       |       |       |      |      |     |       |       |       |     |
| Note on the operating/pilot medium   |       | Lubricated operation possible             |       |       |        |       |       |       |      |      |     |       |       |       |     |
| Temperature of medium                | [°C]  | 0 ... +50                                 |       |       |        |       |       |       |      |      |     |       |       |       |     |
| Ambient temperature                  | [°C]  | 0 ... +50                                 |       |       |        |       |       |       |      |      |     |       |       |       |     |

| Output, general         |         | -B02                | -B2 | -B11 | -V025 | -V05 | -V1 | -P025 | -P05 | -P1 | -P2 | -P6 | -P10 | -P12 | P16 |
|-------------------------|---------|---------------------|-----|------|-------|------|-----|-------|------|-----|-----|-----|------|------|-----|
| Accuracy FS             | [%]     | ±1.5                |     |      |       |      |     |       |      |     |     |     |      |      |     |
| Repetition accuracy     | [%]     | ±0.3                |     |      |       |      |     |       |      |     |     |     |      |      |     |
| Temperature coefficient | [%FS/K] | ±0.05 <sup>1)</sup> |     |      |       |      |     |       |      |     |     |     |      |      |     |

1) For SPAN-B- ±0.1 [%FS/K]

## Data sheet

| <b>Switching output</b>      |                              |        |                        |
|------------------------------|------------------------------|--------|------------------------|
| SPAN-..                      | -PNLK-PNVBA                  | -PN-PN | -B-...-PN              |
| Switching output             | 2x PNP or 2x NPN, switchable |        | 1x PNP/NPN, switchable |
| Switching function           | Window comparator            |        |                        |
|                              | Threshold value comparator   |        |                        |
|                              | Auto difference monitoring   | -      |                        |
| Switching element function   | N/C or N/O, switchable       |        |                        |
| Max. output current [mA]     | 100                          | 80     |                        |
| Short circuit current rating | Yes                          |        |                        |

| <b>Analogue output</b>                      |             |          |           |
|---|-------------|----------|-----------|
| SPAN-...                                    | -PNLK-PNVBA | -PN-PN   | -B-...-PN |
| Analogue output                             | [V]         | 0 ... 10 | -         |
|   | [V]         | 1 ... 5  |           |
|   | [mA]        | 4 ... 20 |           |
| Max. load resistance of current output [Ω]  | 500         |          |           |
| Min. load resistance of voltage output [kΩ] | 20          |          |           |

| <b>IO-Link device to IEC 61131-9</b> |   |
|--------------------------------------|---|
| SPAN-...                             | -PNLK                                   |
| Protocol                             | IO-Link                                 |
| IO-Link                              |   |
| Protocol version                     | Device V 1.1                            |
| Profile                              | Smart sensor profile                    |
| Function classes                     | Binary data channel (BDC)               |
|                                      | Process data variable (PDV)             |
|                                      | Identification                          |
|                                      | Diagnostics                             |
|                                      | Teach channel                           |
| Communication mode                   | COM2 (38.4 kBd)                         |
| SIO mode support                     | Yes                                     |
| Port class                           | A                                       |
| Process data width OUT               | 0 bytes                                 |
| Process data width IN                | 2 bytes                                 |
| Process data content IN              | 14 bit PDV (pressure measurement value) |
|                                      | 2 bit BDC (pressure monitoring)         |
| Minimum cycle time                   | 3 ms                                    |
| Data memory required                 | 0.5 KB                                  |

| <b>Electronics</b>             |                                | SPAN-...  | SPAN-B-...  |
|--------------------------------|--------------------------------|-----------|-------------|
| Operating voltage range DC [V] |                                | 15 ... 30 | 10.8 ... 30 |
| Reverse polarity protection    | For all electrical connections |           |             |
| Electrical connection          | Plug, 4-pin, square design     |           |             |

| <b>Pin allocation</b>  |     |             |  |
|--|-----|-------------|--|
|  | Pin | Wire colour | Allocation   |
|  | 1   | Brown       | Operating voltage +24 V DC                           |
|  | 2   | Black       | Switching output A / IO-Link                         |
|  | 3   | White       | Switching output B / analogue output / not connected |
|  | 4   | Blue        | 0 V DC   |



## Data sheet

| <b>Mechanics</b>                  |                                       |                  |                    |                    |                  |                         |
|-----------------------------------|---------------------------------------|------------------|--------------------|--------------------|------------------|-------------------------|
| SPAN                              | -G18M                                 | -R18M            | -N18M              | -G18F              | -M5F             | -Q4                     |
| Type of mounting                  | Via thread                            |                  |                    |                    |                  | -                       |
|                                   | Front panel mounting                  |                  |                    |                    |                  |                         |
|                                   | Via wall/surface bracket              |                  |                    |                    |                  |                         |
| Pneumatic connection              | Female thread M5 (not for SPAN-B-...) |                  |                    | Female thread G1/8 | Female thread M5 | For tubing<br>O.D. 4 mm |
|                                   | Male thread G1/8                      | Male thread R1/8 | Male thread 1/8NPT | -                  | -                | -                       |
| Product weight [g]                | 46                                    |                  |                    | 34                 | 25               |                         |
|                                   | SPAN-B-... [g]                        | 31               |                    |                    | 21               |                         |
| Mounting position                 | Any                                   |                  |                    |                    |                  |                         |
| Information on materials: Housing | Reinforced PA                         |                  |                    |                    |                  |                         |

|                                  | SPAN |      |       |       |       |       | SPAN-B |      |       |       |       |
|----------------------------------|------|------|-------|-------|-------|-------|--------|------|-------|-------|-------|
|                                  | -Q4  | -M5F | -G18M | -R18M | -N18M | -G18F | -Q4    | -M5F | -G18M | -R18M | -G18F |
| Anodised wrought aluminium alloy |      |      |       |       |       |       |        | •    |       |       |       |
| High-alloy stainless steel       |      | •    | •     | •     | •     | •     |        |      |       |       |       |
| Nickel-plated brass              |      |      |       |       |       |       |        |      | •     | •     |       |
| Reinforced PA                    | •    |      |       |       |       |       | •      | •    | •     | •     | •     |
| FPM                              | •    | •    | •     | •     | •     | •     | •      | •    | •     | •     | •     |
| NBR                              | •    |      |       |       |       |       | •      |      |       |       |       |

| <b>Display/operation</b>          |                      |        |           |
|-----------------------------------|----------------------|--------|-----------|
| SPAN                              | -PNLK                | -PN-PN | -B-...-PN |
| Display type                      | Backlit LCD          |        |           |
| Displayable units <sup>1)</sup>   | MPa                  |        |           |
|                                   | kPa                  |        |           |
|                                   | bar                  |        |           |
|                                   | mbar                 |        | -         |
|                                   | psi                  |        |           |
|                                   | inchH <sub>2</sub> O |        | -         |
|                                   | inchHg               |        | -         |
|                                   | kgf/cm <sup>2</sup>  |        | -         |
| Setting options                   | Teach-in             |        |           |
|                                   | IO-Link              | -      | -         |
|                                   | Display and buttons  |        |           |
| Protection against tampering      | IO-Link              | -      | -         |
|                                   | PIN code             |        |           |
| Threshold value setting range [%] | 0 ... 100            |        |           |
| Hysteresis setting range [%]      | 0 ... 90             |        |           |

1) Dependent on pressure measuring range

| <b>Immission/emission</b>                    |      |
|--|------|
| Degree of protection                         | IP40 |
| Corrosion resistance class CRC <sup>1)</sup> | 2    |

1) Corrosion resistance class 2 to Festo standard 940070

Components subject to moderate corrosion stress. External visible parts with primarily decorative surface requirements which are in direct contact with the surrounding industrial environment or media such as coolants or lubricating agents.

Data sheet

Dimensions

Download CAD data → [www.festo.com](http://www.festo.com)

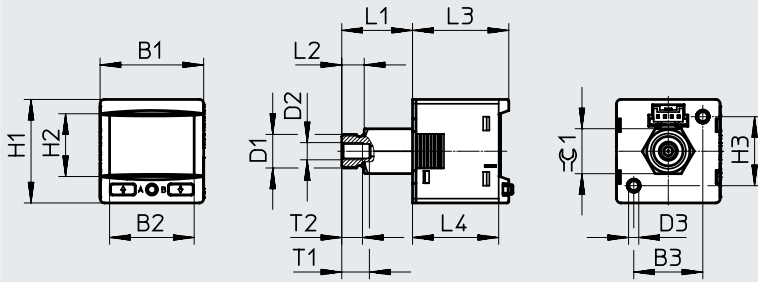

| Type              | B1 | B2   | B3 | D1     | D2 | D3 | H1 | H2   | H3 | L1   | L2  | L3    | L4    | T1 | T2 | $\approx G1$ |
|-------------------|----|------|----|--------|----|----|----|------|----|------|-----|-------|-------|----|----|--------------|
| SPAN-...-G18M-... | 30 | 24.5 | 20 | G1/8   | M5 | M3 | 30 | 18.2 | 20 | 20.5 | 6.5 | ~27.9 | ~25.3 | 8  | 6  | 13           |
| SPAN-...-R18M-... |    |      |    | R1/8   |    |    |    |      |    | 22   | 8   |       |       |    |    |              |
| SPAN-...-N18M-... |    |      |    | 1/8NPT |    |    |    |      |    | 23.5 | 9.5 |       |       |    |    |              |

Dimensions

Download CAD data → [www.festo.com](http://www.festo.com)

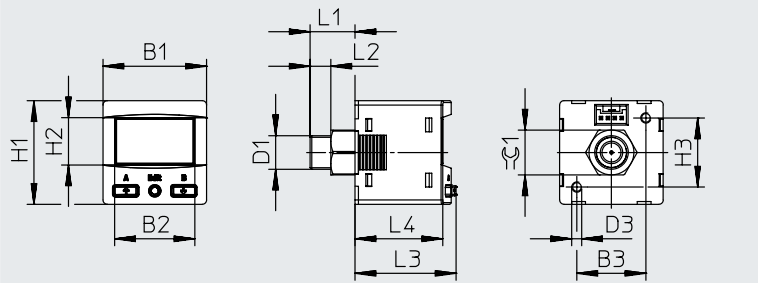

| Type                | B1 | B2   | B3 | D1   | D2 | D3 | H1 | H2   | H3 | L1 | L2 | L3    | L4    | $\approx G1$ |
|---------------------|----|------|----|------|----|----|----|------|----|----|----|-------|-------|--------------|
| SPAN-B-...-G18M-... | 30 | 23.2 | 20 | G1/8 | -  | M3 | 30 | 13.7 | 20 | 13 | 6  | ~29.3 | ~25.3 | 10           |
| SPAN-B-...-R18M-... |    |      |    | R1/8 |    |    |    |      |    | 14 | 8  |       |       |              |

Dimensions

Download CAD data → [www.festo.com](http://www.festo.com)

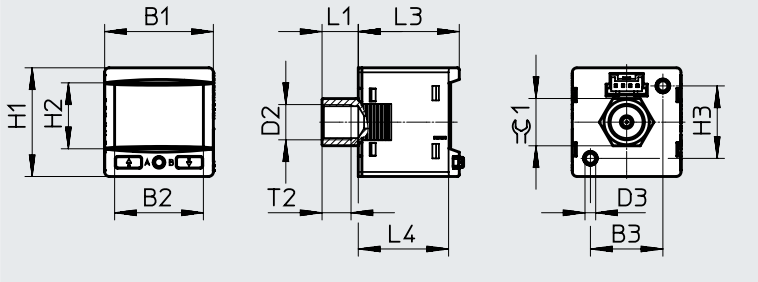

| Type              | B1 | B2   | B3 | D2   | D3 | H1 | H2   | H3 | L1 | L3    | L4    | T2 | $\approx G1$ |
|-------------------|----|------|----|------|----|----|------|----|----|-------|-------|----|--------------|
| SPAN-...-G18F-... | 30 | 24.5 | 20 | G1/8 | M3 | 30 | 18.2 | 20 | 10 | ~27.9 | ~25.3 | 8  | 13           |

Data sheet

Dimensions

Download CAD data → [www.festo.com](http://www.festo.com)

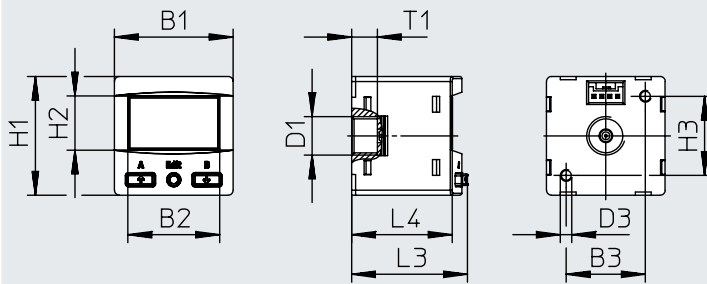

| Type                  | B1 | B2   | B3 | D1   | D3 | H1 | H2   | H3 | L3    | L4    | T1  |
|-----------------------|----|------|----|------|----|----|------|----|-------|-------|-----|
| SPAN-B-...-G18FPM-... | 30 | 23.2 | 20 | G1/8 | M3 | 30 | 13.7 | 20 | ~29.3 | ~25.3 | 6.5 |

Dimensions

Download CAD data → [www.festo.com](http://www.festo.com)

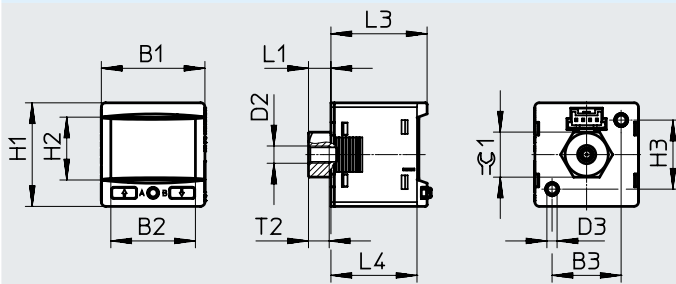

| Type             | B1 | B2   | B3 | D2 | D3 | H1 | H2   | H3 | L1  | L3    | L4    | T2 | ≈C1 |
|------------------|----|------|----|----|----|----|------|----|-----|-------|-------|----|-----|
| SPAN-...-M5F-... | 30 | 24.5 | 20 | M5 | M3 | 30 | 18.2 | 20 | 6.5 | ~27.9 | ~25.3 | 6  | 13  |

Dimensions

Download CAD data → [www.festo.com](http://www.festo.com)

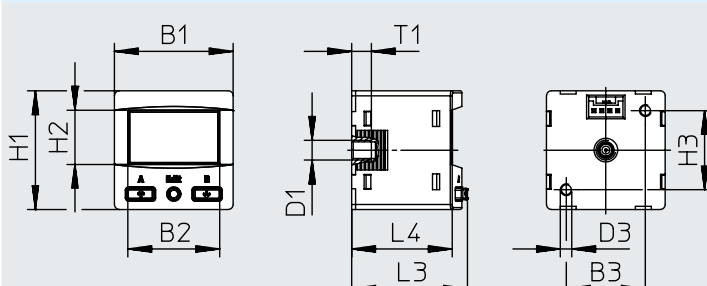

| Type                 | B1 | B2   | B3 | D1 | D3 | H1 | H2   | H3 | L3    | L4    | T1 |
|----------------------|----|------|----|----|----|----|------|----|-------|-------|----|
| SPAN-B-...-M5FAL-... | 30 | 23.2 | 20 | M5 | M3 | 30 | 13.7 | 20 | ~29.3 | ~25.3 | 5  |

Data sheet

Dimensions

Download CAD data → [www.festo.com](http://www.festo.com)

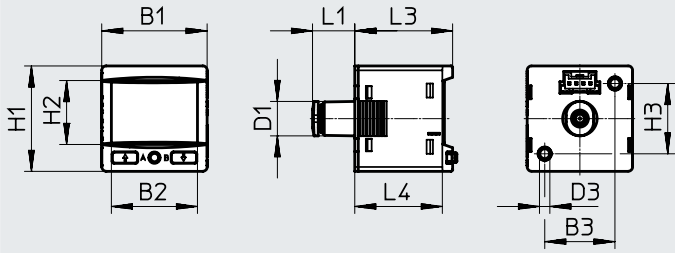

| Type            | B1 | B2   | B3 | D1<br>∅ | D3 | H1 | H2   | H3 | L1 | L3    | L4    |
|-----------------|----|------|----|---------|----|----|------|----|----|-------|-------|
| SPAN-...-Q4-... | 30 | 24.5 | 20 | 9.8     | M3 | 30 | 18.2 | 20 | 12 | ~27.9 | ~25.3 |

Dimensions

Download CAD data → [www.festo.com](http://www.festo.com)

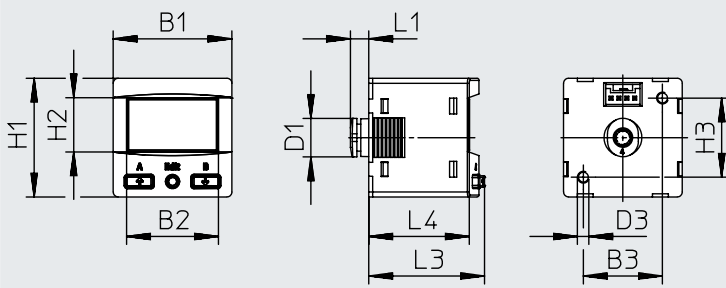

| Type                 | B1 | B2   | B3 | D1  | D3 | H1 | H2   | H3 | L1  | L3    | L4    |
|----------------------|----|------|----|-----|----|----|------|----|-----|-------|-------|
| SPAN-B-...-Q4-PN-... | 30 | 23.2 | 20 | 9.8 | M3 | 30 | 13.7 | 20 | 4.6 | ~29.3 | ~25.3 |

## Data sheet

## ★ Core product range

| Ordering data                                   |  |                  | Pneumatic connection                               | Part no.  | Type                         |
|---|--|------------------|--|-----------|------------------------------|
| Switching output                                | Electrical output<br>Analogue output               | Serial interface |  |           |                              |
| <b>Pressure measuring range -1 ... +1 bar</b>   |  |                  |  |           |                              |
| 2x PNP/NPN,<br>switchable                       | -  | -                | G1/8 male, M5 female                               | ★ 8035545 | SPAN-B2R-G18M-PN-PN-L1       |
|   |  |                  | R1/8 male, M5 female                               | ★ 8035548 | SPAN-B2R-R18M-PN-PN-L1       |
|   |  |                  | M5 female  | ★ 8035551 | SPAN-B2R-M5F-PN-PN-L1        |
| <b>Pressure measuring range 0 ... +10 bar</b>   |  |                  |  |           |                              |
| 2x PNP/NPN,<br>switchable                       | -  | -                | G1/8 male, M5 female                               | ★ 8035544 | SPAN-P10R-G18M-PN-PN-L1      |
|   |  |                  | R1/8 male, M5 female                               | ★ 8035547 | SPAN-P10R-R18M-PN-PN-L1      |
| <b>Ordering data</b>                            |  |                  |  |           |                              |
| Switching output                                | Electrical output<br>Analogue output               | Serial interface | Pneumatic connection                               | Part no.  | Type                         |
| <b>Pressure measuring range 0 ... -1 bar</b>    |  |                  |  |           |                              |
| 2x PNP/NPN,<br>switchable                       | -  | -                | G1/8 male, M5 female                               | 8035546   | SPAN-V1R-G18M-PN-PN-L1       |
|   |  |                  | R1/8 male, M5 female                               | 8035549   | SPAN-V1R-R18M-PN-PN-L1       |
|   |  |                  | Push-in connector 4 mm                             | 8035554   | SPAN-V1R-Q4-PN-PN-L1         |
|   | 0 ... 10 V, 1 ... 5 V<br>4 ... 20 mA<br>Switchable | IO-Link          | G1/8 male, M5 female                               | 8035535   | SPAN-V1R-G18M-PNLK-PNVBA-L1  |
|   |  |                  | R1/8 male, M5 female                               | 8035538   | SPAN-V1R-R18M-PNLK-PNVBA-L1  |
|   |  |                  | Push-in connector 4 mm                             | 8035543   | SPAN-V1R-Q4-PNLK-PNVBA-L1    |
| <b>Pressure measuring range -1 ... +1 bar</b>   |  |                  |  |           |                              |
| 2x PNP/NPN,<br>switchable                       | -  | -                | Push-in connector 4 mm                             | 8035553   | SPAN-B2R-Q4-PN-PN-L1         |
|   |  |                  | 0 ... 10 V, 1 ... 5 V<br>4 ... 20 mA<br>Switchable | IO-Link   | G1/8 male, M5 female         |
|   | R1/8 male, M5 female                               | 8035537          |  |           | SPAN-B2R-R18M-PNLK-PNVBA-L1  |
|   | M5 female  | 8035540          |  |           | SPAN-B2R-M5F-PNLK-PNVBA-L1   |
|   | Push-in connector 4 mm                             | 8035542          | SPAN-B2R-Q4-PNLK-PNVBA-L1                          |           |                              |
| <b>Pressure measuring range 0 ... +10 bar</b>   |  |                  |  |           |                              |
| 2x PNP/NPN,<br>switchable                       | -  | -                | M5 female  | 8035550   | SPAN-P10R-M5F-PN-PN-L1       |
|   |  |                  | Push-in connector 4 mm                             | 8035552   | SPAN-P10R-Q4-PN-PN-L1        |
|   |  |                  | G1/8 female  | 8134896   | SPAN-P10R-G18F-PN-PN-L1      |
|   | 0 ... 10 V, 1 ... 5 V<br>4 ... 20 mA<br>Switchable | IO-Link          | G1/8 male, M5 female                               | 8035533   | SPAN-P10R-G18M-PNLK-PNVBA-L1 |
|   |  |                  | R1/8 male, M5 female                               | 8035536   | SPAN-P10R-R18M-PNLK-PNVBA-L1 |
|   |  |                  | G1/8 female  | 8134897   | SPAN-P10R-G18F-PNLK-PNVBA-L1 |
|   |  |                  | M5 female  | 8035539   | SPAN-P10R-M5F-PNLK-PNVBA-L1  |
|   |  |                  | Push-in connector 4 mm                             | 8035541   | SPAN-P10R-Q4-PNLK-PNVBA-L1   |
| <b>Pressure measuring range: -1 ... +10 bar</b> |  |                  |  |           |                              |
| 2x PNP/NPN,<br>switchable                       | -  | -                | R1/8 male, M5 female                               | 8134891   | SPAN-B11R-R18M-PN-PN-L1      |
|   |  |                  | G1/8 male, M5 female                               | 8134892   | SPAN-B11R-G18M-PN-PN-L1      |
|   |  |                  | M5 female  | 8134893   | SPAN-B11R-M5F-PN-PN-L1       |
|   |  |                  | Push-in connector 4 mm                             | 8134894   | SPAN-B11R-Q4-PN-PN-L1        |
|   | 0 ... 10 V, 1 ... 5 V<br>4 ... 20 mA<br>Switchable | IO-Link          | G1/8 male, M5 female                               | 609149    | SPAN-B11R-G18M-PNLK-PNVBA-L1 |
|   |  |                  | R1/8 male, M5 female                               | 609554    | SPAN-B11R-R18M-PNLK-PNVBA-L1 |
|   |  |                  | M5 female  | 610282    | SPAN-B11R-M5F-PNLK-PNVBA-L1  |
|   |  |                  | Push-in connector 4 mm                             | 8134895   | SPAN-B11R-Q4-PNLK-PNVBA-L1   |

Data sheet SPAN-B

| Ordering data                                 |   |   |          |                               |         |                         |
|---|---|---|----------|-------------------------------|---------|-------------------------|
| Electrical output                             | Accessories                                     | Pneumatic connection                          | Part no. | Type                          |         |                         |
| Switching output                              | Connecting cable                                |   |          |                               |         |                         |
| <b>Pressure measuring range: 0 ... -1 bar</b> |   |   |          |                               |         |                         |
| 1x PNP/NPN,<br>switchable                     | -   | G1/8 male                                     | 8114752  | SPAN-B-V1R-G18M-PN-L1         |         |                         |
|   |   | R1/8 male                                     | 8114755  | SPAN-B-V1R-R18M-PN-L1         |         |                         |
|   |   | M5 female                                     | 8114758  | SPAN-B-V1R-M5FAL-PN-L1        |         |                         |
|   |   | Tubing O.D. 4 mm                              | 8114761  | SPAN-B-V1R-Q4-PN-L1           |         |                         |
|   |   | G1/8 female                                   | 8114764  | SPAN-B-V1R-G18FPM-PN-L1       |         |                         |
|   | NEBS-L1G4-K-2.5-LE4                             | G1/8 male                                     | 8114767  | SPAN-B-V1R-G18M-PN-L1+2.5S    |         |                         |
|   |   | R1/8 male                                     | 8114770  | SPAN-B-V1R-R18M-PN-L1+2.5S    |         |                         |
|   |   | M5 female                                     | 8114773  | SPAN-B-V1R-M5FAL-PN-L1+2.5S   |         |                         |
|   |   | Tubing O.D. 4 mm                              | 8114776  | SPAN-B-V1R-Q4-PN-L1+2.5S      |         |                         |
|   |   | G1/8 female                                   | 8114779  | SPAN-B-V1R-G18FPM-PN-L1+2.5S  |         |                         |
|   |   | <b>Pressure measuring range -1 ... +1 bar</b> |          |                               |         |                         |
|   |   | 1x PNP/NPN,<br>switchable                     | -        | G1/8 male                     | 8114751 | SPAN-B-B2R-G18M-PN-L1   |
|   |   |   |          | R1/8 male                     | 8114754 | SPAN-B-B2R-R18M-PN-L1   |
|   |   |   |          | M5 female                     | 8114757 | SPAN-B-B2R-M5FAL-PN-L1  |
| Tubing O.D. 4 mm                              | 8114760   |   |          | SPAN-B-B2R-Q4-PN-L1           |         |                         |
| G1/8 female                                   | 8114763   |   |          | SPAN-B-B2R-G18FPM-PN-L1       |         |                         |
| NEBS-L1G4-K-2.5-LE4                           | G1/8 male                                       |   | 8114766  | SPAN-B-B2R-G18M-PN-L1+2.5S    |         |                         |
|   | R1/8 male                                       |   | 8114769  | SPAN-B-B2R-R18M-PN-L1+2.5S    |         |                         |
|   | M5 female                                       |   | 8114772  | SPAN-B-B2R-M5FAL-PN-L1+2.5S   |         |                         |
|   | Tubing O.D. 4 mm                                |   | 8114775  | SPAN-B-B2R-Q4-PN-L1+2.5S      |         |                         |
|   | G1/8 female                                     |   | 8114778  | SPAN-B-B2R-G18FPM-PN-L1+2.5S  |         |                         |
|   | <b>Pressure measuring range: -1 ... +10 bar</b> |   |          |                               |         |                         |
|   | 1x PNP/NPN,<br>switchable                       |   | -        | G1/8 male                     | 8114750 | SPAN-B-B11R-G18M-PN-L1  |
|   |   |   |          | R1/8 male                     | 8114753 | SPAN-B-B11R-R18M-PN-L1  |
|   |   |   |          | M5 female                     | 8114756 | SPAN-B-B11R-M5FAL-PN-L1 |
| Tubing O.D. 4 mm                              |   | 8114759                                       |          | SPAN-B-B11R-Q4-PN-L1          |         |                         |
| G1/8 female                                   |   | 8114762                                       |          | SPAN-B-B11R-G18FPM-PN-L1      |         |                         |
| NEBS-L1G4-K-2.5-LE4                           |   | G1/8 male                                     | 8114765  | SPAN-B-B11R-G18M-PN-L1+2.5S   |         |                         |
|   |   | R1/8 male                                     | 8114768  | SPAN-B-B11R-R18M-PN-L1+2.5S   |         |                         |
|   |   | M5 female                                     | 8114771  | SPAN-B-B11R-M5FAL-PN-L1+2.5S  |         |                         |
|   |   | Tubing O.D. 4 mm                              | 8114774  | SPAN-B-B11R-Q4-PN-L1+2.5S     |         |                         |
|   |   | G1/8 female                                   | 8114777  | SPAN-B-B11R-G18FPM-PN-L1+2.5S |         |                         |

## Accessories – Ordering data

### Mounting bracket SAMH-PU-A

Type of mounting: via through-hole and screw. For mounting devices (standing or suspended) on even surfaces.

Material: High-alloy stainless steel

Note on materials: RoHS-compliant

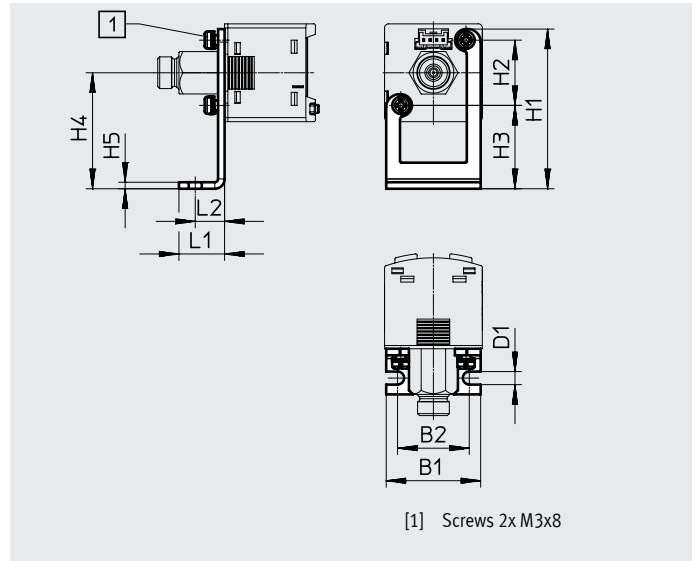

| Ordering data |    |    |         |    |    |      |      |    |    |    |                   |          |           |
|---------------|----|----|---------|----|----|------|------|----|----|----|-------------------|----------|-----------|
| Type          | B1 | B2 | D1<br>∅ | H1 | H2 | H3   | H4   | H5 | L1 | L2 | CRC <sup>1)</sup> | Part no. | Type      |
| SAMH-PU-A     | 29 | 22 | 4       | 49 | 20 | 25.6 | 35.6 | 2  | 14 | 9  | 2                 | 8003354  | SAMH-PU-A |

1) Corrosion resistance class 2 to Festo standard 940070

Components subject to moderate corrosion stress. External visible parts with primarily decorative surface requirements which are in direct contact with the surrounding industrial environment or media such as coolants or lubricating agents.

### Wall mounting SAMH-PN-W

Type of mounting: via through-hole and screw. For mounting devices on vertical surfaces.

Material: high-alloy stainless steel

Note on materials: RoHS-compliant

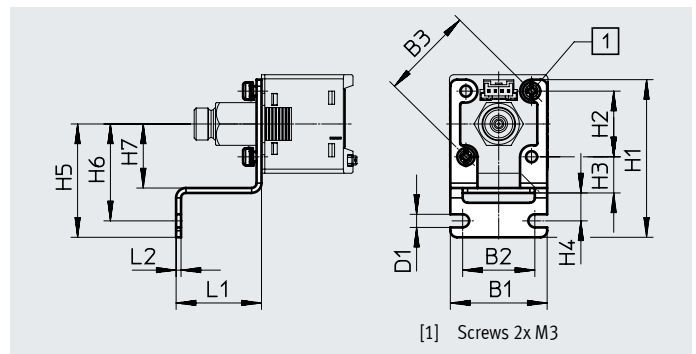
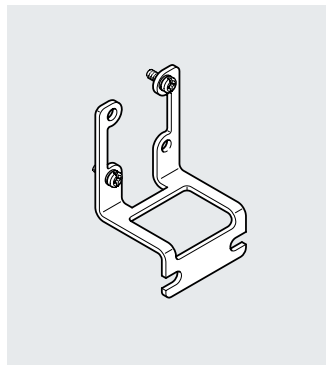

| Dimensions and ordering data |       |    |      |         |    |      |    |     |      |      |      |    |       |                   |           |           |
|------------------------------|-------|----|------|---------|----|------|----|-----|------|------|------|----|-------|-------------------|-----------|-----------|
| Type                         | B1    | B2 | B3   | D1<br>∅ | H1 | H2   | H3 | H4  | H5   | H6   | H7   | L1 | L2    | CRC <sup>1)</sup> | Part no.  | Type      |
|                              | ±0.15 |    | ±0.3 |         |    | ±0.1 |    |     |      |      |      |    | ±0.05 |                   |           |           |
| SAMH-PN-W                    | 29.5  | 22 | 28.3 | 4       | 48 | 20   | 11 | 8.5 | 34.5 | 29.5 | 19.5 | 26 | 1.5   | 2                 | ★ 8035563 | SAMH-PN-W |

1) Corrosion resistance class 2 to Festo standard 940070

Components subject to moderate corrosion stress. External visible parts with primarily decorative surface requirements which are in direct contact with the surrounding industrial environment or media such as coolants or lubricating agents.

## Accessories – Ordering data

### Safety guard

#### SACC-PN-G

To protect the display and control elements

Material: PA

Note on materials:

RoHS-compliant

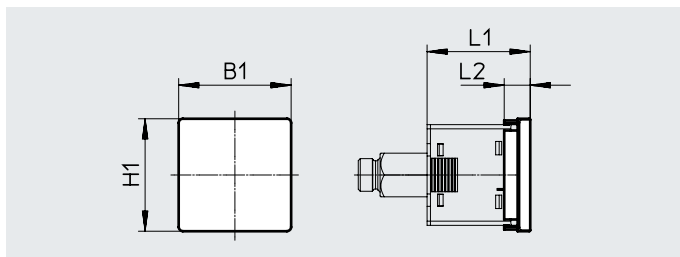

#### Dimensions and ordering data

| Type      | B1   | H1   | L1  | L2  | Part no.  | Type      |
|-----------|------|------|-----|-----|-----------|-----------|
| SACC-PN-G | 33.5 | 33.5 | -31 | 7.7 | ★ 8035560 | SACC-PN-G |

### Front panel mounting kit

#### SAMH-PN-F

Mounting kit for front panel

Material: PA, POM

Note on materials:

RoHS-compliant

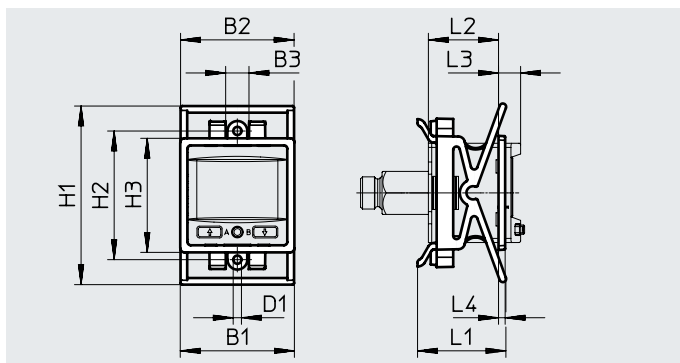

#### Dimensions and ordering data

| Type      | B1   | B2   | B3 | D1<br>∅ | H1   |      | H2   | H3   | L1   | L2    | L3   | L4 | Part no.  | Type      |
|-----------|------|------|----|---------|------|------|------|------|------|-------|------|----|-----------|-----------|
|           |      |      |    |         | min. | max. |      |      |      |       |      |    |           |           |
| SAMH-PN-F | 34.5 | 34.3 | 7  | 2.5     | 54   | 57.5 | 38.9 | 34.5 | 26.8 | ~21.2 | ~6.7 | 2  | ★ 8035561 | SAMH-PN-F |



## Accessories – Ordering data

### Electrical adapter SASC-P4-A-M8-A

For outlet direction underneath<sup>1)</sup>

Material of housing: Reinforced PA

Plug housing: Brass,  
nickel-plated

Note on materials:  
RoHS-compliant

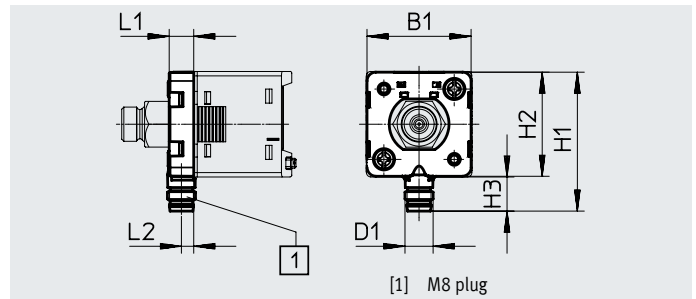

| Dimensions and ordering data |      |      |      |      |     |    |     |                   |          |                |
|------------------------------|------|------|------|------|-----|----|-----|-------------------|----------|----------------|
| Type                         | B1   | D1   | H1   | H2   | H3  | L1 | L2  | CRC <sup>2)</sup> | Part no. | Type           |
| SASC-P4-A-M8-A               | 29.6 | M8x1 | 39.5 | 29.6 | 9.7 | 7  | 3.5 | 2                 | 8000326  | SASC-P4-A-M8-A |

1) Only with connecting cable NEBU-M8...

2) Corrosion resistance class CRC 2 to Festo standard FN 940070

Moderate corrosion stress. Indoor applications in which condensation can occur. External visible parts with primarily decorative surface requirements which are in direct contact with a normal industrial environment.

| Pin allocation    |     |             |  |
|-------------------|-----|-------------|--|
| Plug, 4-pin, M8x1 |     |             |  |
| Round design      | Pin | Core colour | Allocation   |
|                   | 1   | Brown       | Operating voltage +24 V DC                           |
|                   | 2   | White       | Switching output B / analogue output / not connected |
|                   | 3   | Blue        | 0 V DC   |
|                   | 4   | Black       | Switching output A / IO-Link                         |

### Electrical adapter SASC-P4-A-M8-S

For outlet direction to the rear<sup>1)</sup>

Material of housing: Reinforced PA

Plug housing: Brass,  
nickel-plated

Note on materials:  
RoHS-compliant

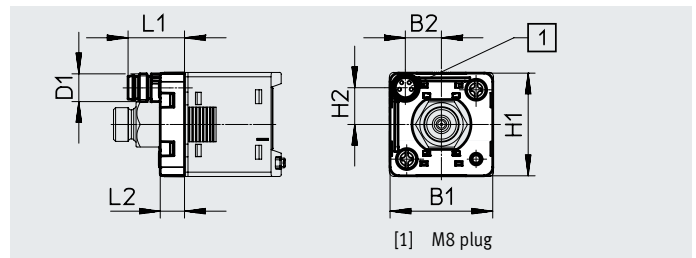

| Dimensions and ordering data |      |      |      |      |      |      |    |                   |          |                |
|------------------------------|------|------|------|------|------|------|----|-------------------|----------|----------------|
| Type                         | B1   | B2   | D1   | H1   | H2   | L1   | L2 | CRC <sup>2)</sup> | Part no. | Type           |
| SASC-P4-A-M8-S               | 29.6 | 10.4 | M8x1 | 29.6 | 10.6 | 16.3 | 7  | 2                 | 8000327  | SASC-P4-A-M8-S |

1) Only with connecting cable NEBU-M8...

2) Corrosion resistance class CRC 2 to Festo standard FN 940070

Moderate corrosion stress. Indoor applications in which condensation can occur. External visible parts with primarily decorative surface requirements which are in direct contact with a normal industrial environment.

| Pin allocation    |     |             |  |
|-------------------|-----|-------------|--|
| Plug, 4-pin, M8x1 |     |             |  |
| Round design      | Pin | Core colour | Allocation   |
|                   | 1   | Brown       | Operating voltage +24 V DC                           |
|                   | 2   | White       | Switching output B / analogue output / not connected |
|                   | 3   | Blue        | 0 V DC   |
|                   | 4   | Black       | Switching output A / IO-Link                         |

## Accessories – Ordering data

### Adapters

#### SASA-PN-A-MG18

Material: Nickel-plated brass

Note on materials: RoHS-compliant

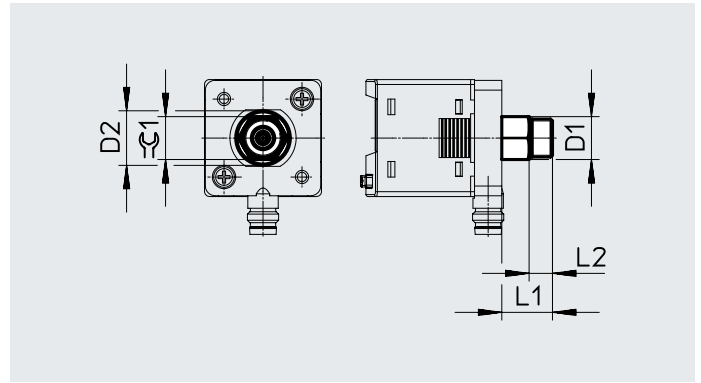









#### Dimensions and ordering data

| Type           | D1   | D2<br>∅ | L1 | L2 | CRC <sup>1)</sup> | ≈C1 | Part no.       | Type                  |
|----------------|------|---------|----|----|-------------------|-----|----------------|-----------------------|
| SASA-PN-A-MG18 | G1/8 | 14      | 13 | 6  | 1                 | 11  | <b>8133310</b> | <b>SASA-PN-A-MG18</b> |

1) Corrosion resistance class CRC 1 to Festo standard FN 940070

Low corrosion stress. Dry indoor application or transport and storage protection. Also applies to parts behind covers, in the non-visible interior area, and parts which are covered in the application (e.g. drive trunnions).

## Accessories – Ordering data

| Ordering data – Connecting cables   |                                       |   |          |                              |
|---|---------------------------------------|---|----------|------------------------------|
|   | Number of wires                       | Cable length [m]  | Part no. | Type                         |
| <b>Socket, rectangular design L1</b>  |                                       |   |          | Data sheets → Internet: nebs |
|    | 4                                     | 2.5   | 572576   | NEBS-L1G4-K-2.5-LE4          |
|   |                                       | 5   | 572577   | NEBS-L1G4-K-5-LE4            |
| <b>M8x1, straight socket</b>  |                                       |   |          | Data sheets → Internet: nebu |
|    | 4                                     | 2.5   | 541342   | NEBU-M8G4-K-2.5-LE4          |
|   |                                       | 5   | 541343   | NEBU-M8G4-K-5-LE4            |
| <b>M8x1, angled socket</b>  |                                       |   |          |                              |
|    | 4                                     | 2.5   | 541344   | NEBU-M8W4-K-2.5-LE4          |
|   |                                       | 5   | 541345   | NEBU-M8W4-K-5-LE4            |
| Ordering data – Push-in fittings  |                                       |   |          |                              |
|   | Pneumatic connection 1<br>With thread | Pneumatic connection 2<br>For tubing O.D. / with thread | Part no. | Type                         |
| <b>Straight connection</b>  |                                       |   |          |                              |
|    | M5                                    | 4 mm  | ★ 153304 | QSM-M5-4                     |
|   |                                       | 6 mm  | ★ 153306 | QSM-M5-6                     |
|    | G1/8                                  | 4 mm  | ★ 186264 | QSM-G1/8-4                   |
|   |                                       | 6 mm  | ★ 186265 | QSM-G1/8-6                   |
| <b>90° connection</b>   |                                       |   |          |                              |
|    | M5                                    | 4 mm  | ★ 153333 | QSML-5-4                     |
|   |                                       | 6 mm  | ★ 153335 | QSML-5-6                     |
|   | G1/8                                  | 4 mm  | ★ 186268 | QSML-G1/8-4                  |
|   |                                       | 6 mm  | ★ 186269 | QSML-G1/8-6                  |
| <b>90° connection</b>   |                                       |   |          | Data sheets → Internet: npfc |
|  | G1/8                                  | G1/8  | 8030209  | NPFC-L-2G18-F                |
|   | R1/8                                  | R1/8  | 8030223  | NPFC-L-2R18-M                |
|   | M5                                    | M5  | 8030215  | NPFC-L-2M5-MF                |
| <b>Straight connection</b>  |                                       |   |          |                              |
|  | G1/8                                  | G1/8  | 8133311  | NPFC-D-2G18-M-F1A            |