

Pressure sensors SPAN

FESTO



Festo Core Range
Solves the majority of your automation tasks

Worldwide: Quickest delivery – wherever, whenever
Simply good: Expected high Festo quality
Fast: Easy and fast to select

With the Festo Core Range, we have selected the most important products and functions from our broad product catalogue, and added the quickest delivery.

The Core Range offers you the best value for your automation tasks.

Just look
for the
star!

Key features

At a glance

Communication interface



Practical design

- Compact design 30x30 mm
- Degree of protection IP40
- Weight reduction with QS4

Universal pressure measurement

- Pressure and vacuum
- 14 pressure measuring ranges
- All standard pressure units
- Optional test report



Easy operation

- Clear display
- Configurable red surround for the entire display
- Intuitive menu navigation

Quick installation

- L1 plug for fast commissioning
- M8 electrical adapters allow maximum flexibility
- Wide range of mounting options
- QS4 quick connector

Switchable electrical outputs

- Various switching functions
- Switching outputs (PNP/NPN, NO/NC)
- Analogue outputs (0 ... 10 V, 1 ... 5 V, 4 ... 20 mA)

Product description

The pressure sensor SPAN is suitable for monitoring compressed air and non-corrosive gases. The sensor can be used in many industries thanks to its compact design. The measuring method is based on a piezoresistive measuring cell for relative pressure measurement. The pressure value is transmitted to the connected controller as a switching signal, as an analogue signal or via IO-Link depending on the sensor variant and selected parameters.

Area of application

- Network monitoring (pressure present)
- Regulator monitoring (pressure in the setpoint range)
- Vacuum (part picked up)
- Leak test (pressure drop over time)
- Object detection (back pressure present)

Functions

- Monitoring and setting a pressure threshold, a pressure range or differential pressure monitoring with teach-in function or by entering values
- ECO function with option to switch off the display
- Optional security code can be freely chosen (4-digit code)
- Adjustable low-pass filter to smooth the pressure signal
- Scaling the analogue output to increase the signal dynamics
- Offset compensation possible
- Min./max. value memory for monitoring compressed air
- All settings that have been carried out on one sensor (master) can be transferred (replication) to identical sensors (device)

Variants with IO-Link

- Serial communication integrated using IO-Link 1.1
- Cyclical transfer of two operating statuses and the measured pressure value
- The sensor can be parameterised remotely using an IO-Link master
- Sensor can be changed easily using automatic parameterisation (hot swap)
- Sensor identification, diagnostics and teach-in via IO-Link possible

2-step connection

- [1] Push in L1 plug
- [2] Push in tubing

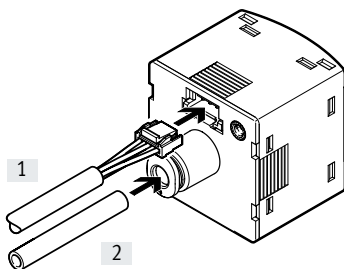

Key features

Mounting options

Front panel mounting

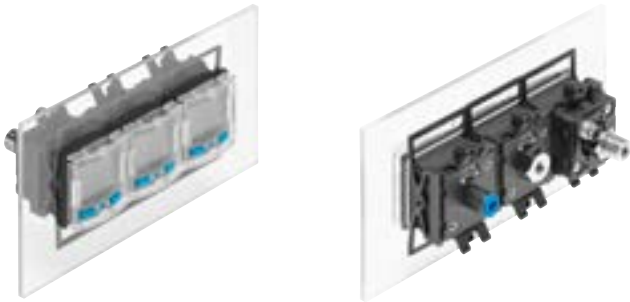

Manifold mounting with mounting bracket

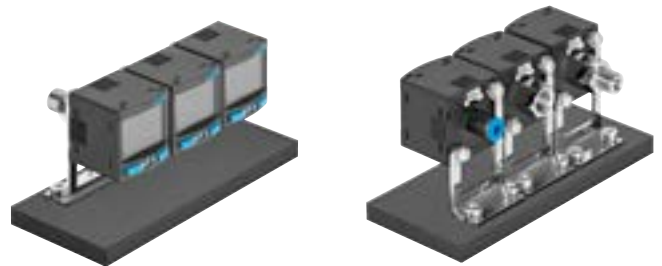

Threaded mounting with M8 adapter



Wall mounting

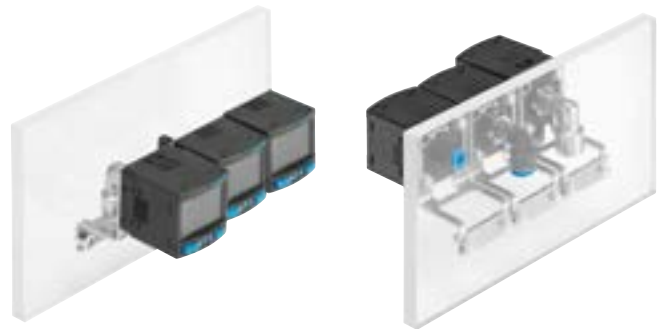

Ordering data – Product options

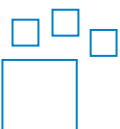

Configurable product
This product and all its product options can be ordered using the configurator.

The configurator can be found under Products on the DVD or at
→ www.festo.com/catalogue/...

Part no.	Type
8003300	SPAN

Product range overview

		Basic variant SPAN-B-...-PN-...	Standard variant Switch SPAN-...-PN-PN-...	Standard variant IO-Link/analogue output SPAN-...-PNLK-PNVBA-...
Pressure range		V1R, B2R, B11R	V1R, P10, B2R, B11R	All possible, see type codes for pressure measuring range
Switching output		1	2	2
Analogue output		-	-	Yes
IO-Link		-	-	Yes
Displayable units		6	9	9
Auto difference Monitoring		-	Yes	Yes
Pressure supply port	G18M/ R18M	Nickel-plated brass, short Without M5 female thread	Stainless steel, long With M5 female thread	Stainless steel, long With M5 female thread
	N18M-	-	Stainless steel, long With M5 female thread	Stainless steel, long With M5 female thread
	G18F-	Polymer	Stainless steel	Stainless steel
	M5F	Aluminium	Stainless steel	Stainless steel
	QS4-	Polymer/stainless steel	Polymer/brass	Polymer/brass
Mounting thread for Accessories		Polymer	Stainless steel	Stainless steel
Test report		-	Yes	Yes

Peripherals overview

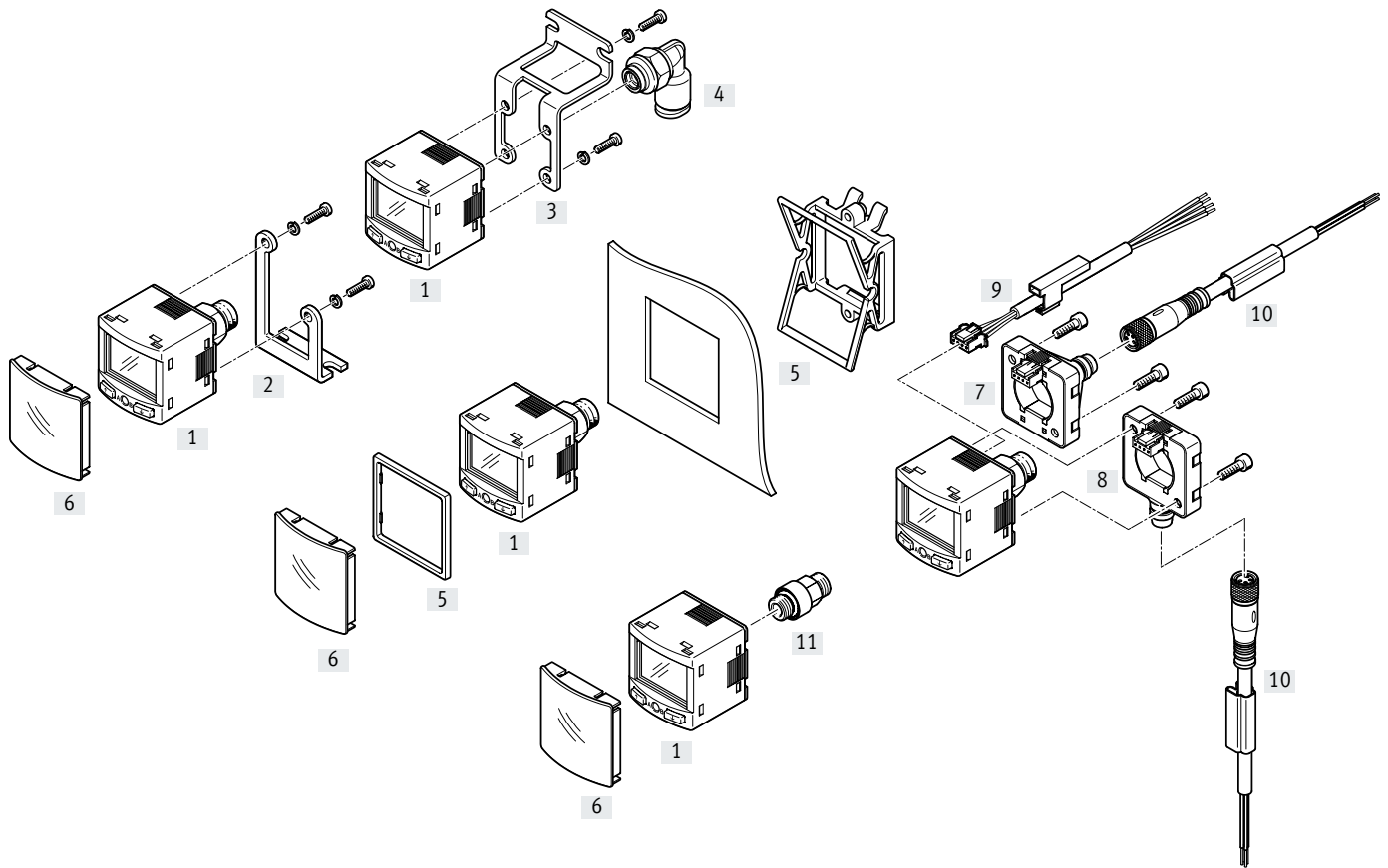

Accessories		→ Page	Accessories		→ Page
[1]	Pressure sensors SPAN-/SPAN-B-	7	[7]	Electrical adapter SASC-P4-A-M8-S	17
[2]	Mounting bracket SAMH-PU-A	15	[8]	Electrical adapter SASC-P4-A-M8-A	17
[3]	Wall mounting SAMH-PN-W	15	[9]	Connecting cable NEBS-L1G4	19
[4]	Push-in fitting QSML-M5	19	[10]	Connecting cable NEBU-M8	19
[5]	Panel mounting kit SAMH-PN-F	16	[11]	Adapter (for -G18FPM- with electrical adapter) SASA-PN-A-MG18	18
[6]	Safety guard SACC-PN-G	16			

Type codes

001	Series
SPAN	Pressure sensor

002	Product version
	Standard
B	Basic

003	Pressure measuring range
B2	-1 ... 1 bar
B02	-0.1 ... 0.1 bar
B11	-1 ... 10 bar
P025	0 ... 0.25 bar
P05	0 ... 0.5 bar
P1	0 ... 1 bar
P2	0 ... 2 bar
P6	0 ... 6 bar
P10	0 ... 10 bar
P12	0 ... 12 bar
P16	0 ... 16 bar
V025	0 ... -0.25 bar
V05	0 ... -0.5 bar
V1	0 ... -1 bar

004	Pressure inlet
R	Relative pressure

005	Pneumatic connection
G18	G1/8
R18	R1/8
N18	1/8 NPT
M5	M5
Q4	Push-in connector 4 mm

006	Thread type
	None
F	Female
M	Male

007	Thread material
	Standard
AL	Aluminium
PM	Polymer

008	Electrical output 1
PN	PNP/NPN
PNLK	PNP/NPN/IO-Link

009	Electrical output 2
	None
PN	PNP or NPN
PNVBA	PNP or NPN or 0 ... 10 V or 1 ... 5 V or 4 ... 20 mA

010	Electrical connection
L1	Plug type L1

011	Mounting accessories
	None
A	Mounting bracket
W	Wall mounting
FP	Front panel mounting kit

012	Electrical adapter
	None
EA	Electrical adapter, angled
ES	Electrical adapter, straight

013	Electrical accessories
	None
5S	Straight socket, cable 5 m
2.5S	Straight socket, cable 2.5 m
5A	Angled socket, cable 5 m
2.5A	Angled socket, cable 2.5 m

014	Protective devices
	None
G	Protective hood

015	Certificate
	None
T	Test report

Data sheet

Variant with IO-Link and analogue outputs ... -PNLK-PNVBA

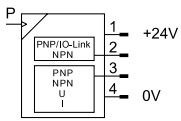

Variant with 2 switching outputs ... -PN-PN

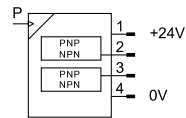

Variant with 1 switching output ... -B-...-PN

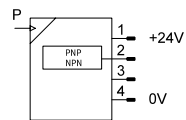

- Compact design 30x30
- 14 pressure measuring ranges
-1 ... +16 bar available
- Voltage 12/24 V DC
- Temperature range 0 ... +50°C
- Degree of protection IP40

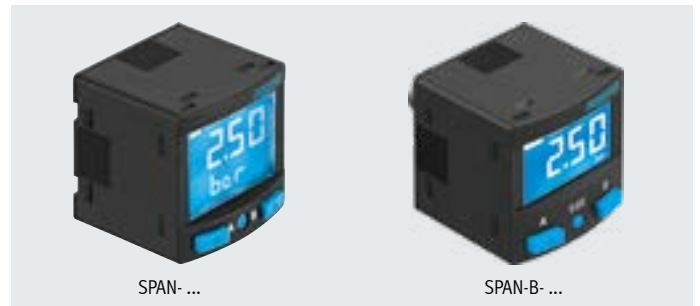

General technical data

Certification	RCM c UL us - Listed (OL) ¹⁾
Certificate issuing authority	UL E322346
CE marking (see declaration of conformity)	To EU EMC Directive To EU RoHS Directive
KC mark	KC EMC
PWIS conformity	VDMA24364-B1/B2-L
Note on materials	RoHS-compliant

1) Not valid for SPAN-B

Input signal, measuring element		-B02	-B2	-B11	-V025	-V05	-V1	-P025	-P05	-P1	-P2	-P6	-P10	-P12	P16
Measured variable		Relative pressure													
Measurement method		Piezoresistive pressure sensor													
Pressure measuring range start value	[MPa]	-0.01	-0.1	-0.1	0										
	[bar]	-0.1	-1	-1	0										
	[psi]	-1.45	-14.5	-14.5	0										
Pressure measuring range end value	[MPa]	0.01	0.1	1	-0.025	-0.05	-0.1	0.025	0.05	0.1	0.2	0.6	1	1.2	1.6
	[bar]	0.1	1	10	-0.25	-0.5	-1	0.25	0.5	1	2	6	10	12	16
	[psi]	1.45	14.5	145	-3.62	-7.25	-14.5	3.62	7.25	14.5	29	87	145	174	232
Max. overload pressure	[MPa]	0.1	0.5	1.5	0.1	0.2	0.5	0.1	0.2	0.5	0.6	1.5	1.5	1.5	2.0
	[bar]	1	5	15	1	2	5	1	2	5	6	15	15	15	20
	[psi]	14.5	72.5	217.5	14.5	29	72.5	14.5	29	72.5	87	217.5	217.5	217.5	290
Operating medium		Compressed air to ISO 8573-1:2010 [7:4:4]													
		Inert gases													
Note on the operating/pilot medium		Lubricated operation possible													
Temperature of medium	[°C]	0 ... +50													
Ambient temperature	[°C]	0 ... +50													

Output, general		-B02	-B2	-B11	-V025	-V05	-V1	-P025	-P05	-P1	-P2	-P6	-P10	-P12	P16
Accuracy FS	[%]	±1.5													
Repetition accuracy	[%]	±0.3													
Temperature coefficient	[%FS/K]	±0.05 ¹⁾													

1) For SPAN-B: ±0.1 [%FS/K]

Data sheet

Switching output		-PNLK-PNVBA	-PN-PN	-B-...-PN
SPAN-...				
Switching output		2x PNP or 2x NPN, switchable		1x PNP/NPN, switchable
Switching function		Window comparator		
		Threshold value comparator		
		Auto difference monitoring	-	
Switching element function		N/C or N/O, switchable		
Max. output current	[mA]	100	80	
Short circuit current rating		Yes		

Analogue output		-PNLK-PNVBA	-PN-PN	-B-...-PN
SPAN-...				
Analogue output	[V]	0 ... 10	-	-
	[V]	1 ... 5		
	[mA]	4 ... 20		
Max. load resistance of current output	[Ω]	500		
Min. load resistance of voltage output	[kΩ]	20		

IO-Link device to IEC 61131-9		-PNLK
SPAN-...		
Protocol		IO-Link
IO-Link		
Protocol version		Device V 1.1
Profile		Smart sensor profile
Function classes		Binary data channel (BDC)
		Process data variable (PDV)
		Identification
		Diagnostics
		Teach channel
Communication mode		COM2 (38.4 kBd)
SIO mode support		Yes
Port class		A
Process data width OUT		0 bytes
Process data width IN		2 bytes
Process data content IN		14 bit PDV (pressure measurement value)
		2 bit BDC (pressure monitoring)
Minimum cycle time		3 ms
Data memory required		0.5 KB

Electronics		SPAN-...	SPAN-B-...
Operating voltage range DC	[V]	15 ... 30	10.8 ... 30
Reverse polarity protection		For all electrical connections	
Electrical connection		Plug, 4-pin, square design	

Pin allocation			
	Pin	Wire colour	Allocation
	1	Brown	Operating voltage +24 V DC
	2	Black	Switching output A / IO-Link
	3	White	Switching output B / analogue output / not connected
	4	Blue	0 V DC

Data sheet

Mechanics						
SPAN	-G18M	-R18M	-N18M	-G18F	-M5F	-Q4
Type of mounting	Via thread					-
	Front panel mounting					
	Via wall/surface bracket					
Pneumatic connection	Female thread M5 (not for SPAN-B-...)			Female thread G1/8	Female thread M5	For tubing O.D. 4 mm
	Male thread G1/8	Male thread R1/8	Male thread 1/8NPT	-	-	-
Product weight [g]	46			34	25	
	SPAN-B-... [g]	31			21	
Mounting position	Any					
Information on materials: Housing	Reinforced PA					

	SPAN						SPAN-B				
	-Q4	-M5F	-G18M	-R18M	-N18M	-G18F	-Q4	-M5F	-G18M	-R18M	-G18F
Anodised wrought aluminium alloy								•			
High-alloy stainless steel		•	•	•	•	•					
Nickel-plated brass									•	•	
Reinforced PA	•						•	•	•	•	•
FPM	•	•	•	•	•	•	•	•	•	•	•
NBR	•						•				

Display/operation				
SPAN	-PNLK	-PN-PN	-B-...-PN	
Display type	Backlit LCD			
Displayable units ¹⁾	MPa			
	kPa			
	bar			
	mbar			-
	psi			
	inchH ₂ O			-
	inchHg			
	kgf/cm ²			-
Setting options	Teach-in			
	IO-Link	-	-	
	Display and buttons			
Protection against tampering	IO-Link	-	-	
	PIN code			
Threshold value setting range [%]	0 ... 100			
Hysteresis setting range [%]	0 ... 90			

1) Dependent on pressure measuring range

Immission/emission	
Degree of protection	IP40
Corrosion resistance class CRC ¹⁾	2

1) Corrosion resistance class 2 to Festo standard 940070

Components subject to moderate corrosion stress. External visible parts with primarily decorative surface requirements which are in direct contact with the surrounding industrial environment or media such as coolants or lubricating agents.

Data sheet

Dimensions

Download CAD data → www.festo.com

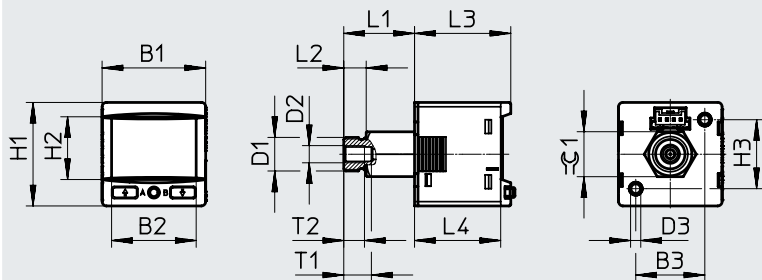

Type	B1	B2	B3	D1	D2	D3	H1	H2	H3	L1	L2	L3	L4	T1	T2	$\approx G1$
SPAN-... -G18M-...	30	24.5	20	G1/8	M5	M3	30	18.2	20	20.5	6.5	~27.9	~25.3	8	6	13
SPAN-... -R18M-...				R1/8						22	8					
SPAN-... -N18M-...				1/8NPT						23.5	9.5					

Dimensions

Download CAD data → www.festo.com

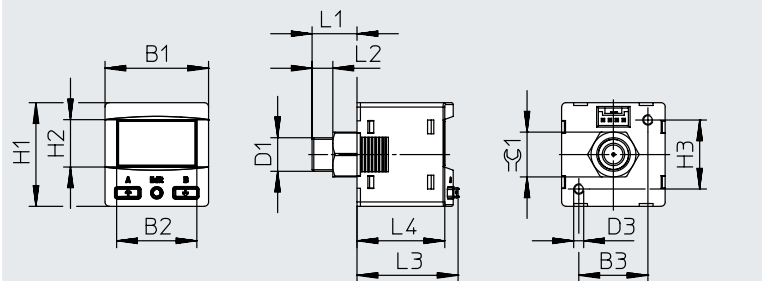

Type	B1	B2	B3	D1	D2	D3	H1	H2	H3	L1	L2	L3	L4	$\approx G1$
SPAN-B-... -G18M-...	30	23.2	20	G1/8	-	M3	30	13.7	20	13	6	~29.3	~25.3	10
SPAN-B-... -R18M-...				R1/8						14	8			

Dimensions

Download CAD data → www.festo.com

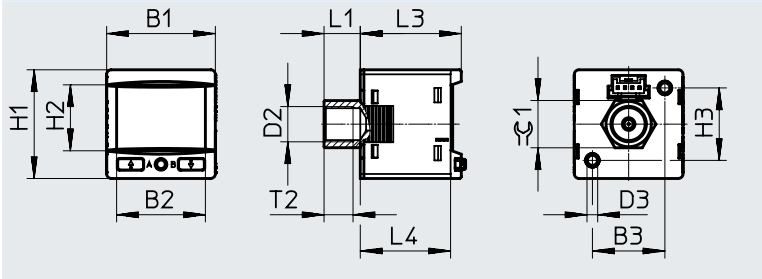

Type	B1	B2	B3	D2	D3	H1	H2	H3	L1	L3	L4	T2	$\approx G1$
SPAN-... -G18F-...	30	24.5	20	G1/8	M3	30	18.2	20	10	~27.9	~25.3	8	13

Data sheet

Dimensions

Download CAD data → www.festo.com

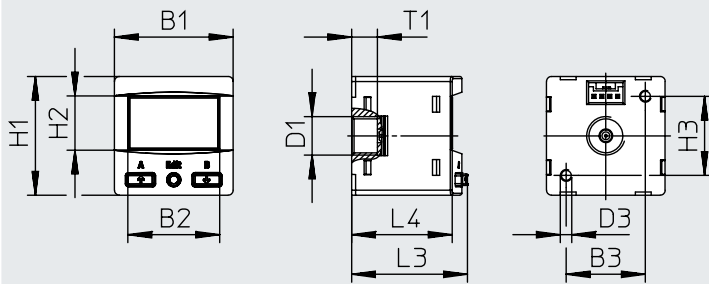

Type	B1	B2	B3	D1	D3	H1	H2	H3	L3	L4	T1
SPAN-B-...-G18FPM-...	30	23.2	20	G1/8	M3	30	13.7	20	~29.3	~25.3	6.5

Dimensions

Download CAD data → www.festo.com

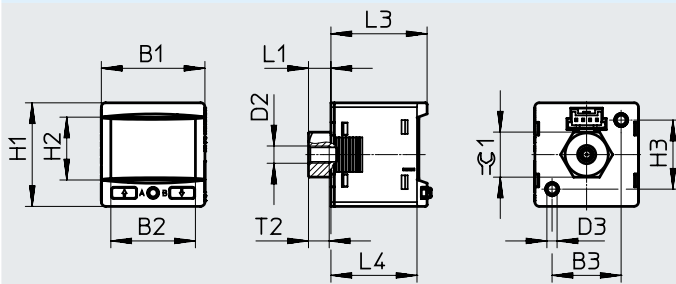

Type	B1	B2	B3	D2	D3	H1	H2	H3	L1	L3	L4	T2	≈C1
SPAN-...-M5F-...	30	24.5	20	M5	M3	30	18.2	20	6.5	~27.9	~25.3	6	13

Dimensions

Download CAD data → www.festo.com

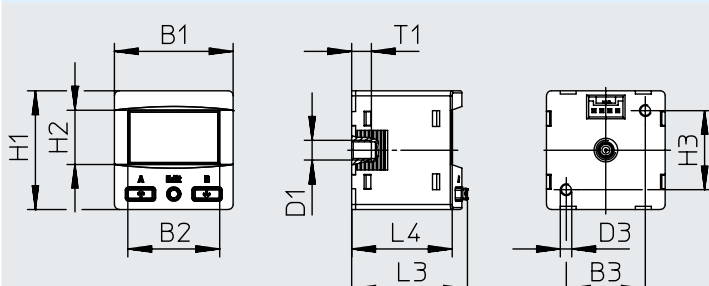

Type	B1	B2	B3	D1	D3	H1	H2	H3	L3	L4	T1
SPAN-B-...-M5FAL-...	30	23.2	20	M5	M3	30	13.7	20	~29.3	~25.3	5

Data sheet

Dimensions

Download CAD data → www.festo.com

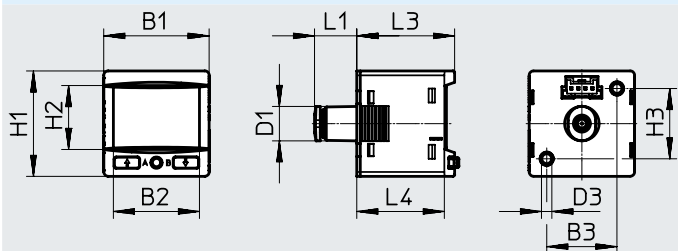

Type	B1	B2	B3	D1 ∅	D3	H1	H2	H3	L1	L3	L4
SPAN-...-Q4-...	30	24.5	20	9.8	M3	30	18.2	20	12	~27.9	~25.3

Dimensions

Download CAD data → www.festo.com

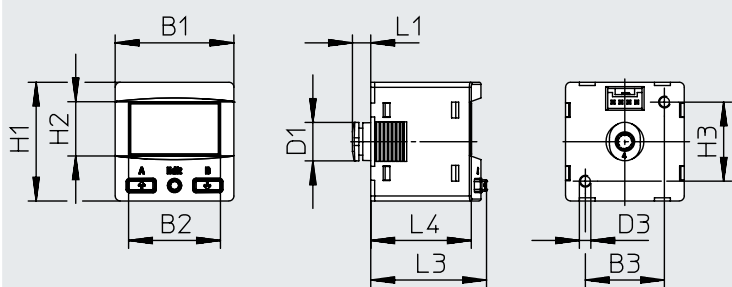

Type	B1	B2	B3	D1	D3	H1	H2	H3	L1	L3	L4
SPAN-B-...-Q4-PN-...	30	23.2	20	9.8	M3	30	13.7	20	4.6	~29.3	~25.3

Data sheet

★ Core product range

Ordering data			Pneumatic connection	Part no.	Type
Switching output	Electrical output				
	Analogue output	Serial interface			
Pressure measuring range -1 ... +1 bar					
2x PNP/NPN, switchable	-	-	G1/8 male, M5 female	★ 8035545	SPAN-B2R-G18M-PN-PN-L1
			R1/8 male, M5 female	★ 8035548	SPAN-B2R-R18M-PN-PN-L1
			M5 female	★ 8035551	SPAN-B2R-M5F-PN-PN-L1
Pressure measuring range 0 ... +10 bar					
2x PNP/NPN, switchable	-	-	G1/8 male, M5 female	★ 8035544	SPAN-P10R-G18M-PN-PN-L1
			R1/8 male, M5 female	★ 8035547	SPAN-P10R-R18M-PN-PN-L1
Ordering data					
Ordering data			Pneumatic connection	Part no.	Type
Switching output	Electrical output				
	Analogue output	Serial interface			
Pressure measuring range 0 ... -1 bar					
2x PNP/NPN, switchable	-	-	G1/8 male, M5 female	8035546	SPAN-V1R-G18M-PN-PN-L1
			R1/8 male, M5 female	8035549	SPAN-V1R-R18M-PN-PN-L1
			Push-in connector 4 mm	8035554	SPAN-V1R-Q4-PN-PN-L1
	0 ... 10 V, 1 ... 5 V 4 ... 20 mA Switchable	IO-Link	G1/8 male, M5 female	8035535	SPAN-V1R-G18M-PNLK-PNVBA-L1
			R1/8 male, M5 female	8035538	SPAN-V1R-R18M-PNLK-PNVBA-L1
			Push-in connector 4 mm	8035543	SPAN-V1R-Q4-PNLK-PNVBA-L1
Pressure measuring range -1 ... +1 bar					
2x PNP/NPN, switchable	-	-	Push-in connector 4 mm	8035553	SPAN-B2R-Q4-PN-PN-L1
			0 ... 10 V, 1 ... 5 V 4 ... 20 mA Switchable	IO-Link	G1/8 male, M5 female
	R1/8 male, M5 female	8035537			SPAN-B2R-R18M-PNLK-PNVBA-L1
	M5 female	8035540			SPAN-B2R-M5F-PNLK-PNVBA-L1
	Push-in connector 4 mm	8035542	SPAN-B2R-Q4-PNLK-PNVBA-L1		
Pressure measuring range 0 ... +10 bar					
2x PNP/NPN, switchable	-	-	M5 female	8035550	SPAN-P10R-M5F-PN-PN-L1
			Push-in connector 4 mm	8035552	SPAN-P10R-Q4-PN-PN-L1
			G1/8 female	8134896	SPAN-P10R-G18F-PN-PN-L1
	0 ... 10 V, 1 ... 5 V 4 ... 20 mA Switchable	IO-Link	G1/8 male, M5 female	8035533	SPAN-P10R-G18M-PNLK-PNVBA-L1
			R1/8 male, M5 female	8035536	SPAN-P10R-R18M-PNLK-PNVBA-L1
			G1/8 female	8134897	SPAN-P10R-G18F-PNLK-PNVBA-L1
			M5 female	8035539	SPAN-P10R-M5F-PNLK-PNVBA-L1
			Push-in connector 4 mm	8035541	SPAN-P10R-Q4-PNLK-PNVBA-L1
Pressure measuring range: -1 ... +10 bar					
2x PNP/NPN, switchable	-	-	R1/8 male, M5 female	8134891	SPAN-B11R-R18M-PN-PN-L1
			G1/8 male, M5 female	8134892	SPAN-B11R-G18M-PN-PN-L1
			M5 female	8134893	SPAN-B11R-M5F-PN-PN-L1
			Push-in connector 4 mm	8134894	SPAN-B11R-Q4-PN-PN-L1
	0 ... 10 V, 1 ... 5 V 4 ... 20 mA Switchable	IO-Link	G1/8 male, M5 female	609149	SPAN-B11R-G18M-PNLK-PNVBA-L1
			R1/8 male, M5 female	609554	SPAN-B11R-R18M-PNLK-PNVBA-L1
			M5 female	610282	SPAN-B11R-M5F-PNLK-PNVBA-L1
			Push-in connector 4 mm	8134895	SPAN-B11R-Q4-PNLK-PNVBA-L1

Data sheet SPAN-B

Ordering data						
Electrical output	Accessories	Pneumatic connection	Part no.	Type		
Switching output	Connecting cable					
Pressure measuring range: 0 ... -1 bar						
1x PNP/NPN, switchable	-	G1/8 male	8114752	SPAN-B-V1R-G18M-PN-L1		
		R1/8 male	8114755	SPAN-B-V1R-R18M-PN-L1		
		M5 female	8114758	SPAN-B-V1R-M5FAL-PN-L1		
		Tubing O.D. 4 mm	8114761	SPAN-B-V1R-Q4-PN-L1		
		G1/8 female	8114764	SPAN-B-V1R-G18FPM-PN-L1		
	NEBS-L1G4-K-2.5-LE4	G1/8 male	8114767	SPAN-B-V1R-G18M-PN-L1+2.5S		
		R1/8 male	8114770	SPAN-B-V1R-R18M-PN-L1+2.5S		
		M5 female	8114773	SPAN-B-V1R-M5FAL-PN-L1+2.5S		
		Tubing O.D. 4 mm	8114776	SPAN-B-V1R-Q4-PN-L1+2.5S		
		G1/8 female	8114779	SPAN-B-V1R-G18FPM-PN-L1+2.5S		
		Pressure measuring range -1 ... +1 bar				
		1x PNP/NPN, switchable	-	G1/8 male	8114751	SPAN-B-B2R-G18M-PN-L1
				R1/8 male	8114754	SPAN-B-B2R-R18M-PN-L1
				M5 female	8114757	SPAN-B-B2R-M5FAL-PN-L1
Tubing O.D. 4 mm	8114760			SPAN-B-B2R-Q4-PN-L1		
G1/8 female	8114763			SPAN-B-B2R-G18FPM-PN-L1		
NEBS-L1G4-K-2.5-LE4	G1/8 male		8114766	SPAN-B-B2R-G18M-PN-L1+2.5S		
	R1/8 male		8114769	SPAN-B-B2R-R18M-PN-L1+2.5S		
	M5 female		8114772	SPAN-B-B2R-M5FAL-PN-L1+2.5S		
	Tubing O.D. 4 mm		8114775	SPAN-B-B2R-Q4-PN-L1+2.5S		
	G1/8 female		8114778	SPAN-B-B2R-G18FPM-PN-L1+2.5S		
	Pressure measuring range: -1 ... +10 bar					
	1x PNP/NPN, switchable		-	G1/8 male	8114750	SPAN-B-B11R-G18M-PN-L1
				R1/8 male	8114753	SPAN-B-B11R-R18M-PN-L1
				M5 female	8114756	SPAN-B-B11R-M5FAL-PN-L1
Tubing O.D. 4 mm		8114759		SPAN-B-B11R-Q4-PN-L1		
G1/8 female		8114762		SPAN-B-B11R-G18FPM-PN-L1		
NEBS-L1G4-K-2.5-LE4		G1/8 male	8114765	SPAN-B-B11R-G18M-PN-L1+2.5S		
		R1/8 male	8114768	SPAN-B-B11R-R18M-PN-L1+2.5S		
		M5 female	8114771	SPAN-B-B11R-M5FAL-PN-L1+2.5S		
		Tubing O.D. 4 mm	8114774	SPAN-B-B11R-Q4-PN-L1+2.5S		
		G1/8 female	8114777	SPAN-B-B11R-G18FPM-PN-L1+2.5S		

Accessories – Ordering data

Mounting bracket SAMH-PU-A

Type of mounting: via through-hole and screw. For mounting devices (standing or suspended) on even surfaces.

Material: High-alloy stainless steel

Note on materials: RoHS-compliant

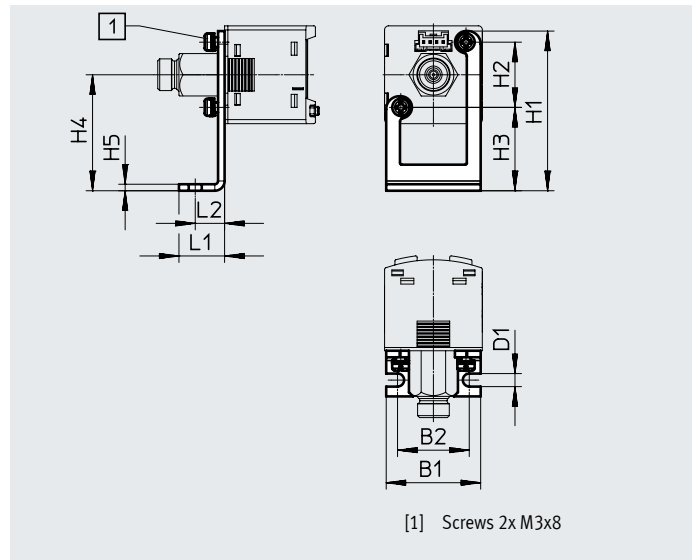

Ordering data													
Type	B1	B2	D1 ∅	H1	H2	H3	H4	H5	L1	L2	CRC ¹⁾	Part no.	Type
SAMH-PU-A	29	22	4	49	20	25.6	35.6	2	14	9	2	8003354	SAMH-PU-A

1) Corrosion resistance class 2 to Festo standard 940070

Components subject to moderate corrosion stress. External visible parts with primarily decorative surface requirements which are in direct contact with the surrounding industrial environment or media such as coolants or lubricating agents.

Wall mounting SAMH-PN-W

Type of mounting: via through-hole and screw. For mounting devices on vertical surfaces.

Material: high-alloy stainless steel

Note on materials: RoHS-compliant

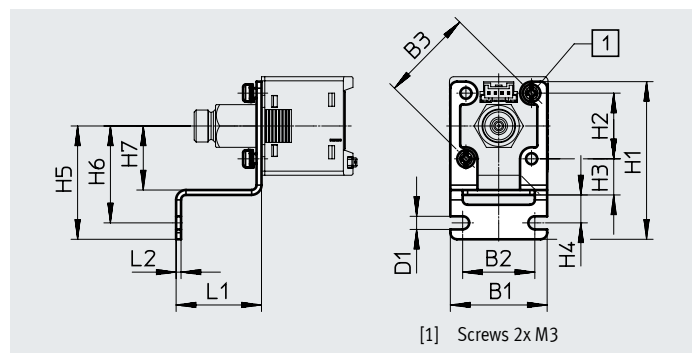
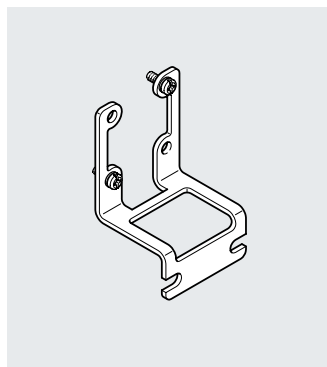

Dimensions and ordering data																
Type	B1	B2	B3	D1 ∅	H1	H2	H3	H4	H5	H6	H7	L1	L2	CRC ¹⁾	Part no.	Type
	±0.15		±0.3			±0.1							±0.05			
SAMH-PN-W	29.5	22	28.3	4	48	20	11	8.5	34.5	29.5	19.5	26	1.5	2	★ 8035563	SAMH-PN-W

1) Corrosion resistance class 2 to Festo standard 940070

Components subject to moderate corrosion stress. External visible parts with primarily decorative surface requirements which are in direct contact with the surrounding industrial environment or media such as coolants or lubricating agents.

Accessories – Ordering data

Safety guard

SACC-PN-G

To protect the display and control elements

Material: PA

Note on materials:

RoHS-compliant

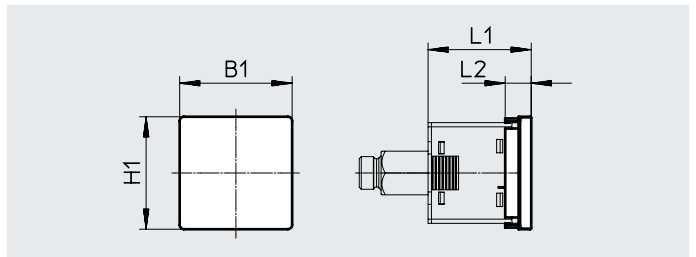

Dimensions and ordering data

Type	B1	H1	L1	L2	Part no.	Type
SACC-PN-G	33.5	33.5	-31	7.7	★ 8035560	SACC-PN-G

Front panel mounting kit

SAMH-PN-F

Mounting kit for front panel

Material: PA, POM

Note on materials:

RoHS-compliant

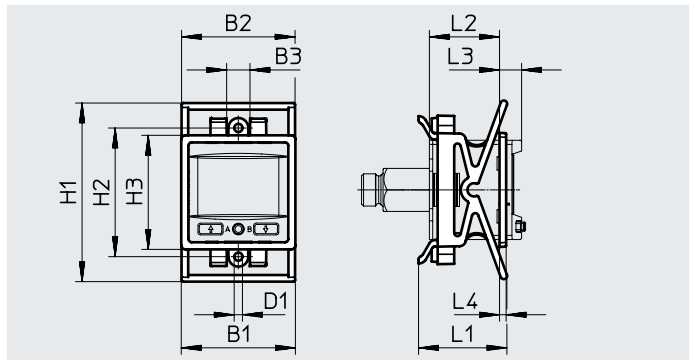

Dimensions and ordering data

Type	B1	B2	B3	D1 ∅	H1		H2	H3	L1	L2	L3	L4	Part no.	Type
					min.	max.								
SAMH-PN-F	34.5	34.3	7	2.5	54	57.5	38.9	34.5	26.8	~21.2	~6.7	2	★ 8035561	SAMH-PN-F

Accessories – Ordering data

Electrical adapter SASC-P4-A-M8-A

For outlet direction underneath¹⁾

Material of housing: Reinforced PA

Plug housing: Brass,
nickel-plated

Note on materials:
RoHS-compliant

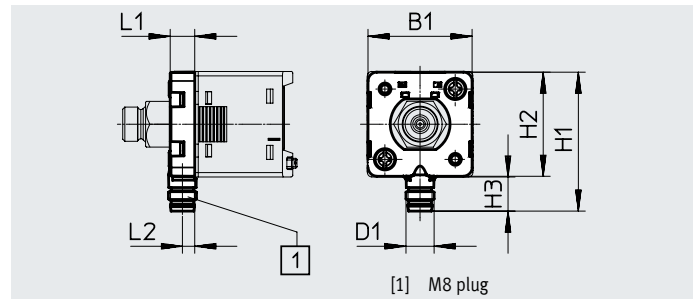

Dimensions and ordering data										
Type	B1	D1	H1	H2	H3	L1	L2	CRC ²⁾	Part no.	Type
SASC-P4-A-M8-A	29.6	M8x1	39.5	29.6	9.7	7	3.5	2	8000326	SASC-P4-A-M8-A

1) Only with connecting cable NEBU-M8...

2) Corrosion resistance class CRC 2 to Festo standard FN 940070

Moderate corrosion stress. Indoor applications in which condensation can occur. External visible parts with primarily decorative surface requirements which are in direct contact with a normal industrial environment.

Pin allocation			
Plug, 4-pin, M8x1			
Round design	Pin	Core colour	Allocation
	1	Brown	Operating voltage +24 V DC
	2	White	Switching output B / analogue output / not connected
	3	Blue	0 V DC
	4	Black	Switching output A / IO-Link

Electrical adapter SASC-P4-A-M8-S

For outlet direction to the rear¹⁾

Material of housing: Reinforced PA

Plug housing: Brass,
nickel-plated

Note on materials:
RoHS-compliant

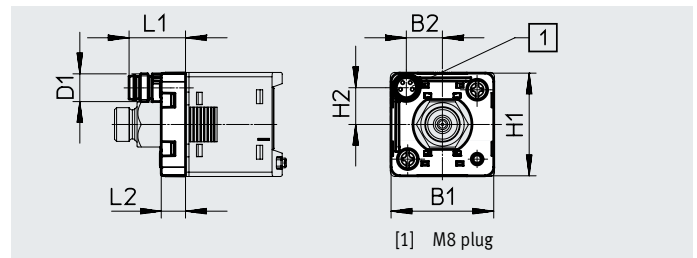

Dimensions and ordering data										
Type	B1	B2	D1	H1	H2	L1	L2	CRC ²⁾	Part no.	Type
SASC-P4-A-M8-S	29.6	10.4	M8x1	29.6	10.6	16.3	7	2	8000327	SASC-P4-A-M8-S

1) Only with connecting cable NEBU-M8...

2) Corrosion resistance class CRC 2 to Festo standard FN 940070

Moderate corrosion stress. Indoor applications in which condensation can occur. External visible parts with primarily decorative surface requirements which are in direct contact with a normal industrial environment.

Pin allocation			
Plug, 4-pin, M8x1			
Round design	Pin	Core colour	Allocation
	1	Brown	Operating voltage +24 V DC
	2	White	Switching output B / analogue output / not connected
	3	Blue	0 V DC
	4	Black	Switching output A / IO-Link

Accessories – Ordering data

Adapters

SASA-PN-A-MG18

Material: Nickel-plated brass

Note on materials: RoHS-compliant

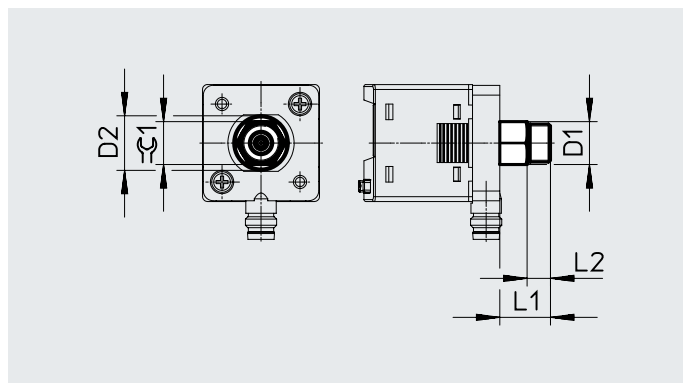









Dimensions and ordering data

Type	D1	D2 ∅	L1	L2	CRC ¹⁾	≈C1	Part no.	Type
SASA-PN-A-MG18	G1/8	14	13	6	1	11	8133310	SASA-PN-A-MG18

1) Corrosion resistance class CRC 1 to Festo standard FN 940070

Low corrosion stress. Dry indoor application or transport and storage protection. Also applies to parts behind covers, in the non-visible interior area, and parts which are covered in the application (e.g. drive trunnions).

Accessories – Ordering data

Ordering data – Connecting cables				
	Number of wires	Cable length [m]	Part no.	Type
Socket, rectangular design L1				Data sheets → Internet: nebs
	4	2.5	572576	NEBS-L1G4-K-2.5-LE4
		5	572577	NEBS-L1G4-K-5-LE4
M8x1, straight socket				Data sheets → Internet: nebu
	4	2.5	541342	NEBU-M8G4-K-2.5-LE4
		5	541343	NEBU-M8G4-K-5-LE4
M8x1, angled socket				
	4	2.5	541344	NEBU-M8W4-K-2.5-LE4
		5	541345	NEBU-M8W4-K-5-LE4
Ordering data – Push-in fittings				
	Pneumatic connection 1 With thread	Pneumatic connection 2 For tubing O.D. / with thread	Part no.	Type
Straight connection				
	M5	4 mm	★ 153304	QSM-M5-4
		6 mm	★ 153306	QSM-M5-6
	G1/8	4 mm	★ 186264	QSM-G1/8-4
		6 mm	★ 186265	QSM-G1/8-6
90° connection				
	M5	4 mm	★ 153333	QSML-5-4
		6 mm	★ 153335	QSML-5-6
	G1/8	4 mm	★ 186268	QSML-G1/8-4
		6 mm	★ 186269	QSML-G1/8-6
90° connection				Data sheets → Internet: npfc
	G1/8	G1/8	8030209	NPFC-L-2G18-F
	R1/8	R1/8	8030223	NPFC-L-2R18-M
	M5	M5	8030215	NPFC-L-2M5-MF
Straight connection				
	G1/8	G1/8	8133311	NPFC-D-2G18-M-F1A