

## CONMUTADOR ALUMINIO

REF. G8220133

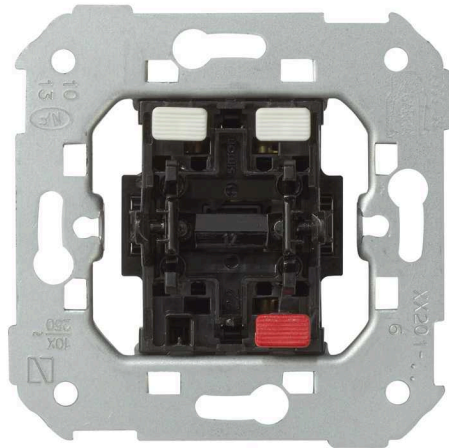

### INFORMACIÓN BÁSICA

#### EMBALAJE

Retráctil

#### CLASE ETIM

EC001590

### INFORMACIÓN TÉCNICA

## NORMATIVA

### GARANTÍA

3 años

## INFORMACIÓN LOGÍSTICA

### CÓDIGO EAN UNITARIO

8412852026107

### ALTURA EMBALAJE UNITARIO

0

### ANCHO EMBALAJE UNITARIO

0

### LONGITUD EMBALAJE UNITARIO

0

### VOLUMEN EMBALAJE UNITARIO

0

### PESO BRUTO EMBALAJE

#### UNITARIO

0.06

### PESO NETO DEL PRODUCTO

0.06

### UNIDAD DE PESO EMBALAJE

#### UNITARIO

KGM

### EAN EMBALAJE

18412852026104

### UDS. CONTENIDAS EMBALAJE

10

### ALTURA EMBALAJE

85

### ANCHO EMBALAJE

165

### LONGITUD EMBALAJE

220

### UNIDAD DE MEDIDA EMBALAJE

MMT

### VOLUMEN EMBALAJE

3085500

### UNIDAD DE VOLUMEN

#### EMBALAJE

MMQ

### PESO BRUTO EMBALAJE

0.62

### PESO NETO EMBALAJE

0.6

### UNIDAD DE PESO EMBALAJE

KGM

# MECANISMOS SIMON 31, 75, 77, 82 Y 88

## Mecanismos básicos / Basic switches

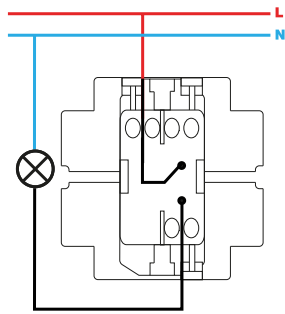

Interruptor unipolar / Single-pole switch  
XXXX101-XXX

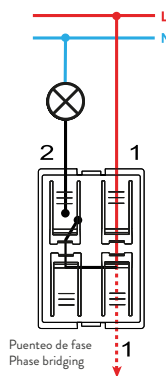

Interruptor unipolar / Single-pole switch  
7700101-039

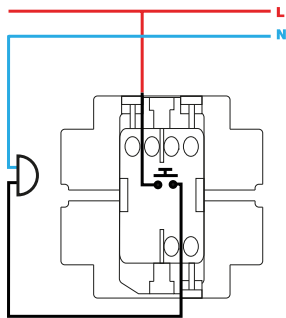

Pulsador / Push button switch  
XXXX150-XXX

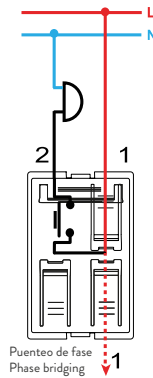

Pulsador / Push button switch  
7700150-039

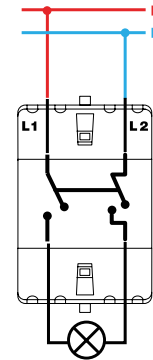

Interruptor bipolar / Double pole switch  
XXXX133-XXX

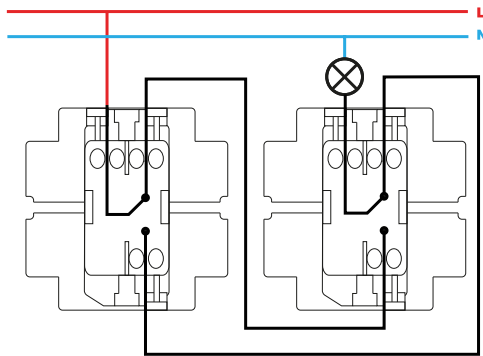

Conmutador / 2-way switch  
XXXX201-XXX

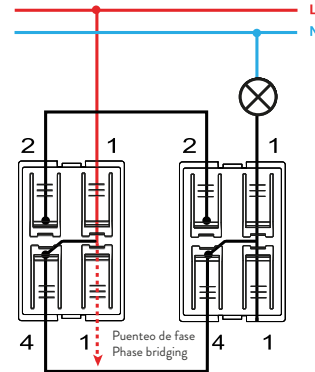

Conmutador / 2-way switch  
7700201-039

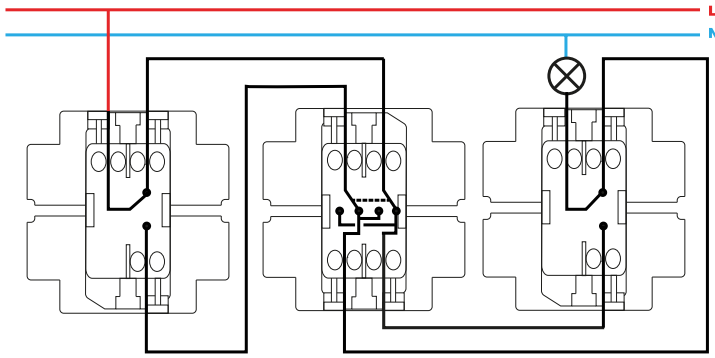

Conmutador cruce / Intermediate switch  
XXXX251-XXX

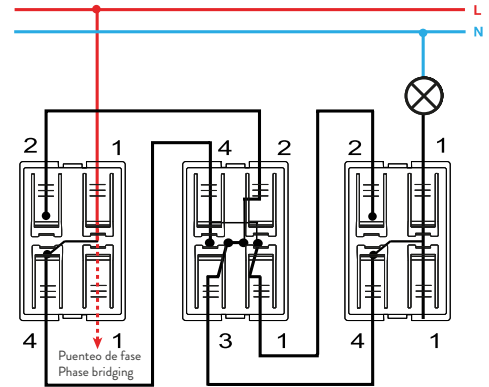

Conmutador cruce / Intermediate switch  
7700251-039

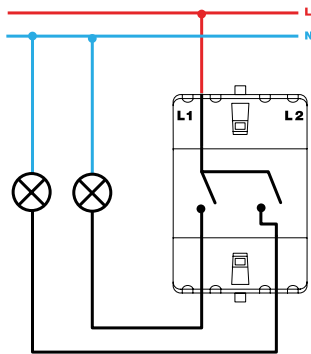

Grupo 2 interruptores / 2 switches group  
XXXX398-XXX

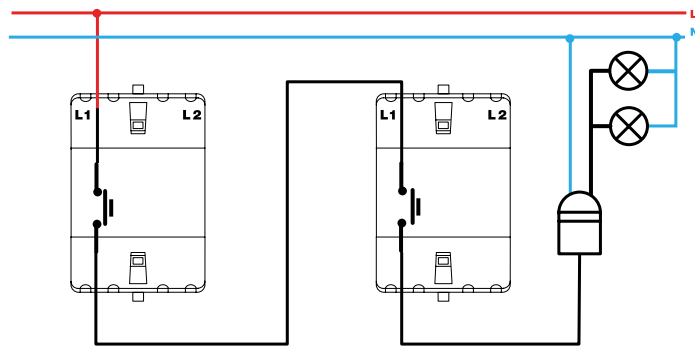

Pulsador desconexión / Push button disconnection switch  
XXXX152-XXX

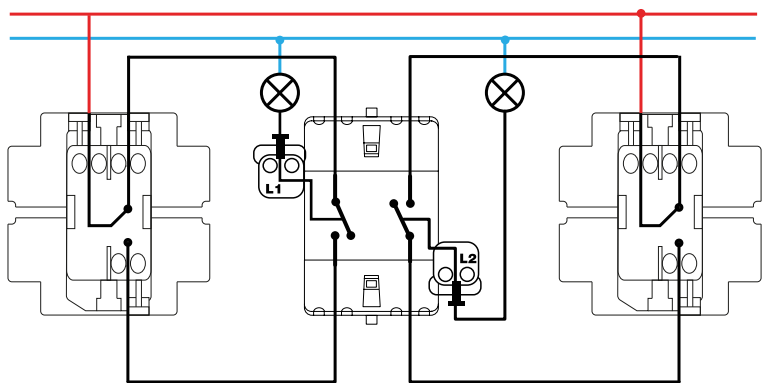

Grupo dos conmutadores / 2-way switches group  
XXXX397-XXX

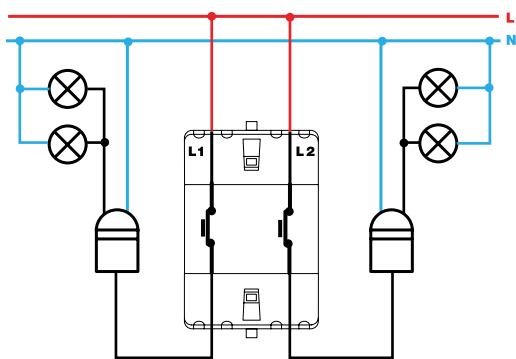

Grupo de pulsadores desconexión / Push button disconnection group  
XXXX395-XXX

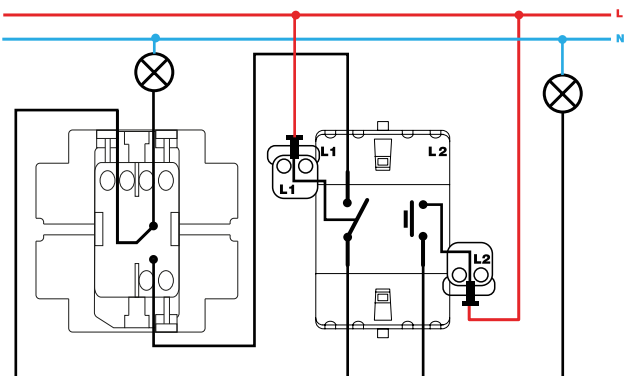

Grupo conmutador y pulsador / 2-way and push button switch group  
XXXX301-XXX

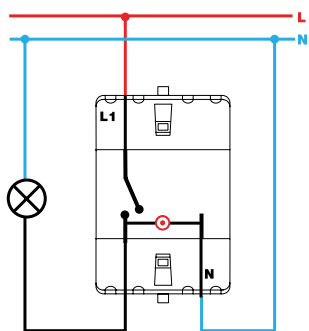

Interruptor unipolar / Single-pole switch  
XXXX102-XXX

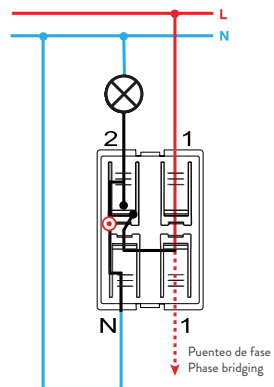

Interruptor con piloto / Push button pilot switch  
7700112-039

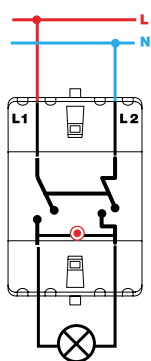

Interruptor bipolar / Double pole switch  
XXXX134-XXX

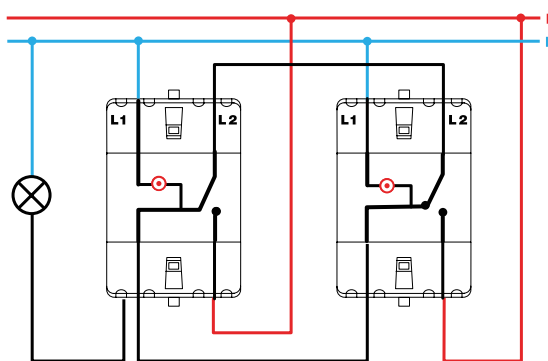

Conmutador / 2-way switch  
XXXX202-XXX

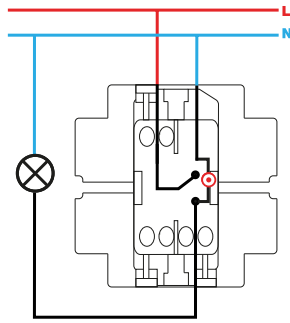

Interrupor unipolar con luminoso / Single-pole switch with light  
XXXX104-XXX

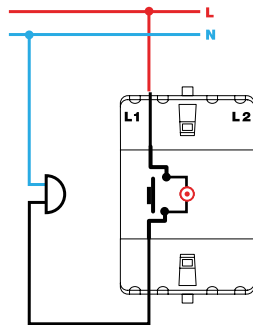

Pulsador con luminoso / Push button switch with light  
XXXX160-XXX

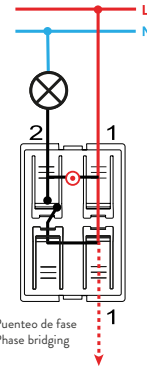

Pulsador con luminoso / Push button switch with light  
7700160-039

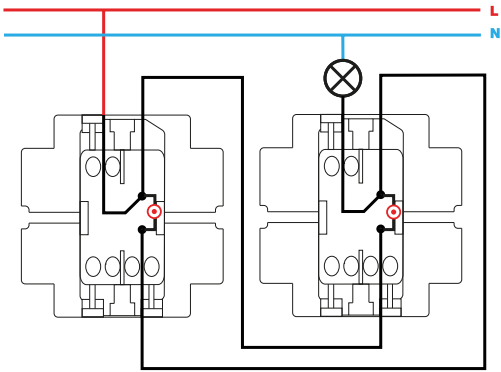

Conmutador con luminoso / 2-way switch with light  
XXXX204-XXX

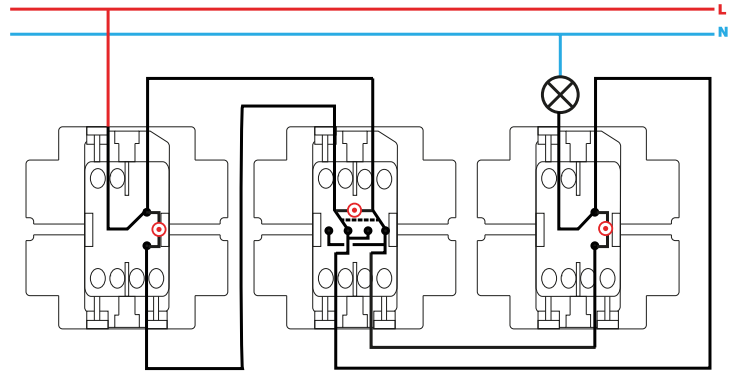

Conmutador cruce con luminoso / Intermediate switch with light  
XXXX254-XXX