

CONMUTADOR CRUCE BLANCO

REF. M8225130

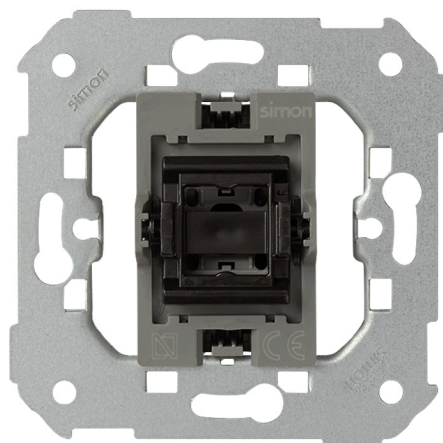

INFORMACIÓN BÁSICA

EMBALAJE

Blíster

CLASE ETIM

EC001590

INFORMACIÓN TÉCNICA

NORMATIVA

GARANTÍA

3 años

INFORMACIÓN LOGÍSTICA

CÓDIGO EAN UNITARIO	PESO NETO DEL PRODUCTO	UNIDAD DE MEDIDA EMBALAJE
8412852007021	0.085	MMT
ALTURA EMBALAJE UNITARIO	UNIDAD DE PESO EMBALAJE UNITARIO	VOLUMEN EMBALAJE
0	KGM	4781920
ANCHO EMBALAJE UNITARIO	EAN EMBALAJE	UNIDAD DE VOLUMEN EMBALAJE
0	18412852007028	MMQ
LONGITUD EMBALAJE UNITARIO	UDS. CONTENIDAS EMBALAJE	PESO BRUTO EMBALAJE
0	5	0.52
VOLUMEN EMBALAJE UNITARIO	ALTURA EMBALAJE	PESO NETO EMBALAJE
956384	152	0.425
UNIDAD DE VOLUMEN EMBALAJE UNITARIO	ANCHO EMBALAJE	UNIDAD DE PESO EMBALAJE
MMQ	110	KGM
PESO BRUTO EMBALAJE UNITARIO	LONGITUD EMBALAJE	
0.085	286	

MECANISMOS SIMON 31, 75, 77, 82 Y 88

Mecanismos básicos / Basic switches



Interruptor unipolar / Single-pole switch
XXXX101-XXX

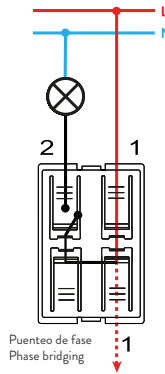

Interruptor unipolar / Single-pole switch
7700101-039

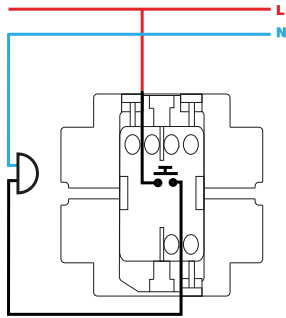

Pulsador / Push button switch
XXXX150-XXX

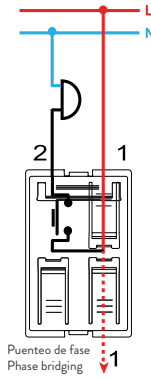

Pulsador / Push button switch
7700150-039

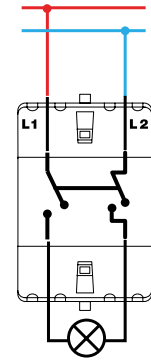

Interruptor bipolar / Double pole switch
XXXX133-XXX



Conmutador / 2-way switch
XXXX201-XXX



Conmutador / 2-way switch
7700201-039



Conmutador cruce / Intermediate switch
XXXX251-XXX



Conmutador cruce / Intermediate switch
7700251-039



Grupo 2 interruptores / 2 switches group
XXXX398-XXX

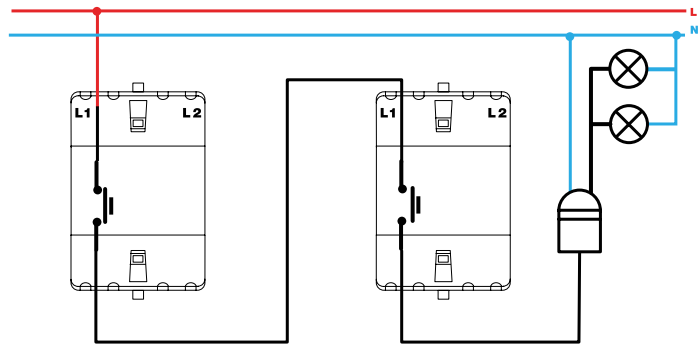

Pulsador desconexión / Push button disconnection switch
XXXX152-XXX



Grupo dos conmutadores / 2-way switches group
XXXX397-XXX

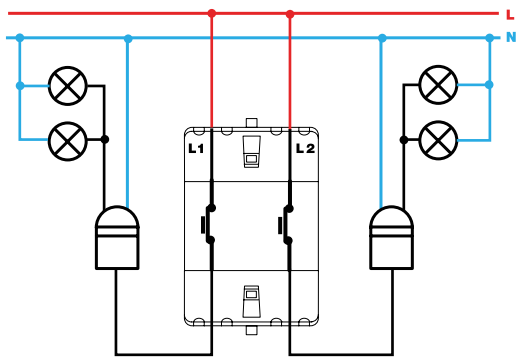

Grupo de pulsadores desconexión / Push button disconnection group
XXXX395-XXX

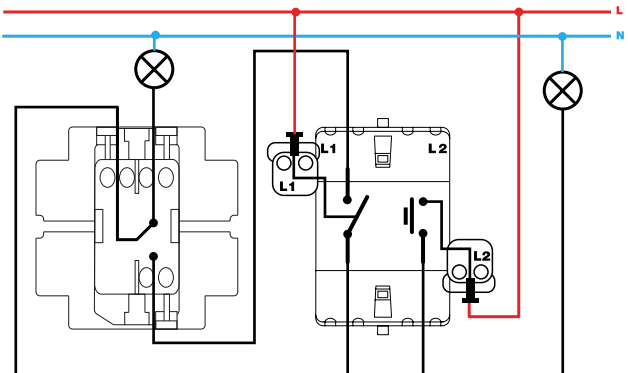

Grupo conmutador y pulsador / 2-way and push button switch group
XXXX301-XXX



Interruptor unipolar / Single-pole switch
XXXX102-XXX



Interruptor con piloto / Push button pilot switch
7700112-039

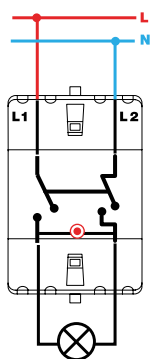

Interruptor bipolar / Double pole switch
XXXX134-XXX

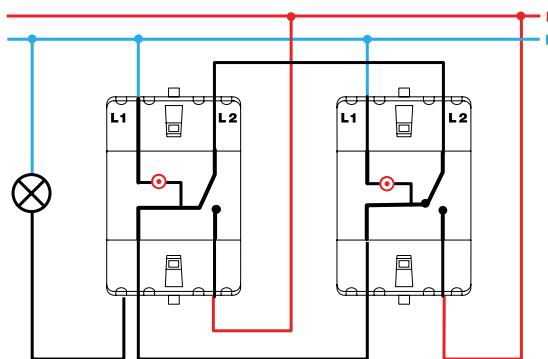

Conmutador / 2-way switch
XXXX202-XXX



Interrupor unipolar con luminoso / Single-pole switch with light
XXXX104-XXX



Pulsador con luminoso / Push button switch with light
XXXX160-XXX



Pulsador con luminoso / Push button switch with light
7700160-039



Conmutador con luminoso / 2-way switch with light
XXXX204-XXX



Conmutador cruce con luminoso / Intermediate switch with light
XXXX254-XXX