

Single-pole switch 10AX 250V~ with 1click® terminal connection system

REF. 7700101-039

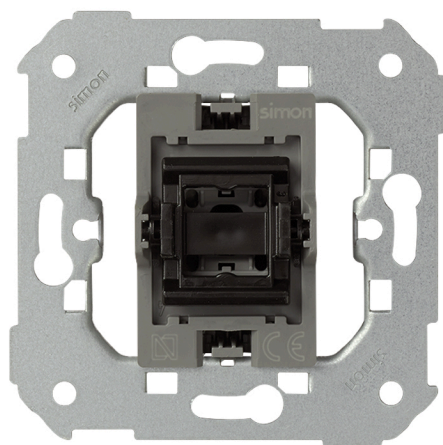

BASIC INFORMATION

DESCRIPTION

Single-pole switch with 10 AX current and a voltage of 250V, with 1click® terminal connection system, belonging to the Simon 77 series. The Simon 77 series offers new mechanisms that allow you to emborn without having to strip or braid the wire and you will not have to use additional tools to place them, so we will reduce the installation time. The Simon 77 mechanisms are fully compatible with Simon 82, Simon 82 Nature, Simon 75 and Simon 88. It has a rocker operation and offers the possibility of implementing signaling function via cradle blinking and rocker with viewer. This switch can be installed in surface-mounted and recessed in a place with a temperature located between 5 and 40°C, although it can withstand extreme temperatures of -25 to 50°C, approximately. It supports a cable section of 1.5 to 2.5 mm and has been manufactured with metal components with halogen-free thermoplastic insulation, complying, in addition, in its manufacture, with the regulations UNE-EN 60669-1: 2002 + A1: 2003 + A2: 2009, UNE EN 60998-2-3: 2005.

COMPATIBILITY

Simon 75, Simon 82 Detail, Simon 82 Nature, Simon 82 and Simon 88 frames

PACKAGING CONTENTS

Mechanism and instructions

ETIM CLASS

EC001590

REMARKS

Possibility of implementing signalling function using cradle blinking and rocker with viewer.

TECHNICAL INFORMATION

AVAILABLE MARKET

CE

CURRENT (A)

10 AX

STORAGE TEMPERATURE RANGE (°C)

-25 - 50 °C

CABLE SECTION ADMITTED (MM)

From 1,5 to 2,5 mm

TYPE OF MECHANISM

Pivoting

VERSION

Single

NUMBER OF POSSIBLE ELEMENTS

1 element

OPERATING TEMPERATURE RANGE (°C)

5 - 40 °C

VOLTAGE (V~)

250 V~

INDICATOR FUNCTION

No

INSTALLATION AND MAINTENANCE

CLAW

Simon 27

INSTALLATION TYPE

Suitable for surface and flush mounting

TYPE OF TERMINAL

CONNECTION - FUNCTION 1

1 click connection (1 click®)

INSTALLABLE IN FLUSH MOUNT JUNCTION BOX

Universal

REGULATIONS

REGULATIONS

Directive 2014/35/UE LVD + Directive 2011/65/UE RoHS + EN 50581:2012 + EN 60669-1:1999 + EN 60669-1:1999 A1:2002 + EN 60669-1:1999 A2:2008 + EN 60998-2-3:2004

LOGISTICS INFORMATION

UNITARY EAN CODE	UNITARY PACKAGING GROSS WEIGHT	PACKAGING LENGTH
8421053256442	0.061	223
UNITARY PACKAGING HEIGHT	PRODUCT NET WEIGHT	PACKAGING MEASUREMENT UNIT
0	0.061	MMT
UNITARY PACKAGING WIDTH	UNITARY PACKAGING WEIGHT UNIT	PACKAGING VOLUME
0	KGM	3.027
UNITARY PACKAGING LENGTH	PACKAGING EAN	PACKAGING VOLUME UNIT
0	8421053075814	DMQ
UNITARY PACKAGING MEASUREMENT UNIT	UNITS CONTAINED PACKAGING	PACKAGING GROSS WEIGHT
MMT	10	0.61
UNITARY PACKAGING VOLUME	PACKAGING HEIGHT	PACKAGING NET WEIGHT
0	82	0.61
UNITARY PACKAGING VOLUME UNIT	PACKAGING WIDTH	PACKAGING WEIGHT UNIT
MMQ	165	KGM

MECANISMOS SIMON 31, 75, 77, 82 Y 88

Mecanismos básicos / Basic switches



Interruptor unipolar / Single-pole switch
XXXX101-XXX

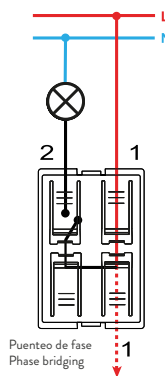

Interruptor unipolar / Single-pole switch
7700101-039



Pulsador / Push button switch
XXXX150-XXX



Pulsador / Push button switch
7700150-039



Interruptor bipolar / Double pole switch
XXXX133-XXX

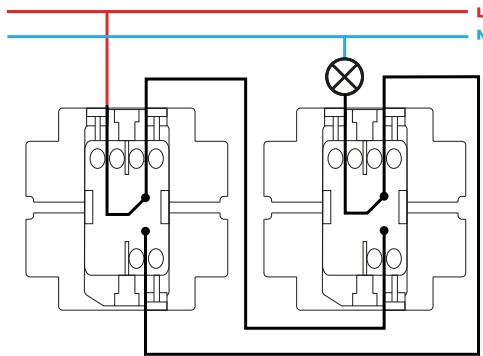

Conmutador / 2-way switch
XXXX201-XXX



Conmutador / 2-way switch
7700201-039



Conmutador cruce / Intermediate switch
XXXX251-XXX

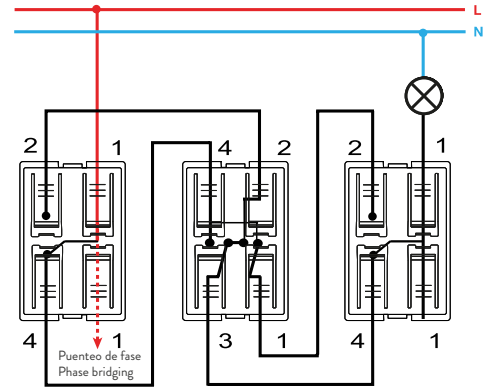

Conmutador cruce / Intermediate switch
7700251-039



Grupo 2 interruptores / 2 switches group
XXXX398-XXX



Pulsador desconexión / Push button disconnection switch
XXXX152-XXX



Grupo dos conmutadores / 2-way switches group
XXXX397-XXX

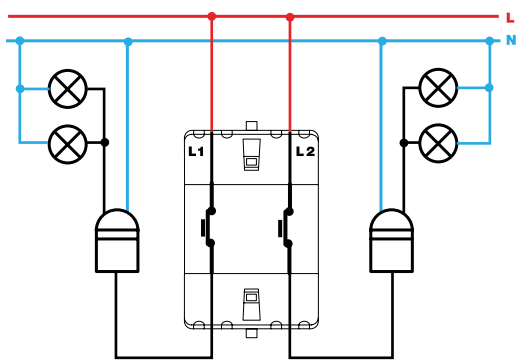

Grupo de pulsadores desconexión / Push button disconnection group
XXXX395-XXX



Grupo conmutador y pulsador / 2-way and push button switch group
XXXX301-XXX



Interruptor unipolar / Single-pole switch
XXXX102-XXX



Interruptor con piloto / Push button pilot switch
7700112-039



Interruptor bipolar / Double pole switch
XXXX134-XXX



Conmutador / 2-way switch
XXXX202-XXX



Interrupor unipolar con luminoso / Single-pole switch with light
XXXX104-XXX

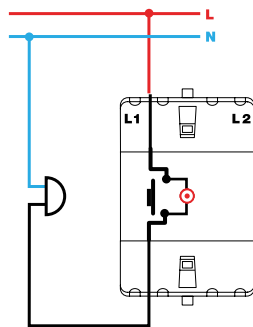

Pulsador con luminoso / Push button switch with light
XXXX160-XXX

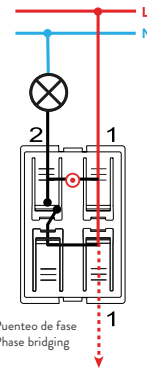

Pulsador con luminoso / Push button switch with light
7700160-039

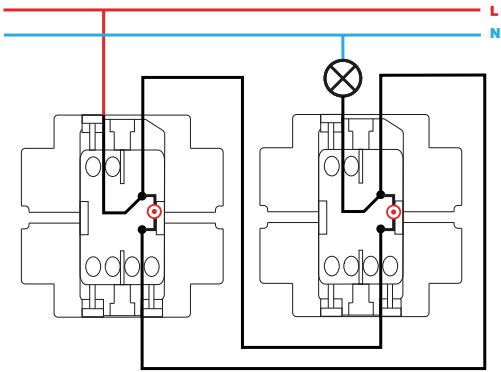

Conmutador con luminoso / 2-way switch with light
XXXX204-XXX

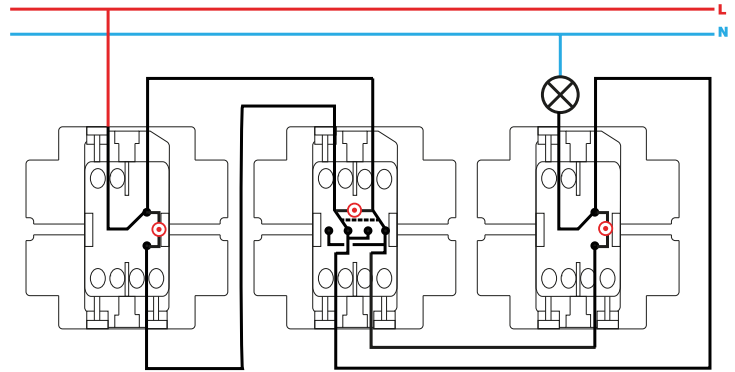

Conmutador cruce con luminoso / Intermediate switch with light
XXXX254-XXX