

Conjunto semi-montado de cruzamiento 10 AX 250~ con sistema de embornamiento rápido blanco mate Simon 82 Concept

REF. 8200251-090



INFORMACIÓN BÁSICA

ACABADO

Blanco mate

EMBALAJE

Flowpack

CLASE ETIM

EC001590

COMPATIBILIDAD

Simon 82 Concept

CONTENIDO DEL EMBALAJE

Mecanismo

INFORMACIÓN TÉCNICA

MERCADO DISPONIBLE CE	FUNCIÓN INDICADORA No	RANGO DE TEMPERATURA DE FUNCIONAMIENTO (°C) 5 - 40 °C
SECCIÓN DE CABLE ADMITIDA (MM) De 2,5 mm	INTENSIDAD (A) 10 AX	RANGO DE TEMPERATURA DE ALMACENAMIENTO (°C) -25 - 50 °C
NÚMERO DE ELEMENTOS POSIBLES 1 elemento	CLASIFICACIÓN IP IP20	VERSIÓN Individual
FORMATO Tecla, mecanismo y bastidor	TIPO DE MECANISMO Pivoting	TENSIÓN (V~) 250 V~
	MONOBLOQUE No	

INSTALACIÓN Y MANTENIMIENTO

GARRA Sin posibilidad	TIPO DE INSTALACIÓN Apto para superficie y empotrar
INSTALABLE EN CAJA DE EMPOTRAR Universal	TIPO DE CONEXIÓN DE TERMINAL - FUNCIÓN 1 Rápido

NORMATIVA

GARANTÍA
3 años

REGULACIONES

Dir. 2014/35/UE LVD | Dir. 2011/65/UE RoHS + post. mod. EN 60669-1:2018 | EN IEC 63000:2018

INFORMACIÓN LOGÍSTICA

CÓDIGO EAN UNITARIO 8421053279823	PESO BRUTO EMBALAJE UNITARIO 0.078	LONGITUD EMBALAJE 223
ALTURA EMBALAJE UNITARIO 0	PESO NETO DEL PRODUCTO 0.078	UNIDAD DE MEDIDA EMBALAJE MMT
ANCHO EMBALAJE UNITARIO 0	UNIDAD DE PESO EMBALAJE UNITARIO KGM	VOLUMEN EMBALAJE 3017190
LONGITUD EMBALAJE UNITARIO 0	EAN EMBALAJE 8421053228104	UNIDAD DE VOLUMEN EMBALAJE MMQ
UNIDAD DE MEDIDA EMBALAJE UNITARIO MMT	UDS. CONTENIDAS EMBALAJE 5	PESO BRUTO EMBALAJE 0.392
VOLUMEN EMBALAJE UNITARIO 0	ALTURA EMBALAJE 82	PESO NETO EMBALAJE 0.39
UNIDAD DE VOLUMEN EMBALAJE UNITARIO MMQ	ANCHO EMBALAJE 165	UNIDAD DE PESO EMBALAJE KGM

MECANISMOS SIMON 31, 75, 77, 82 Y 88

Mecanismos básicos / Basic switches

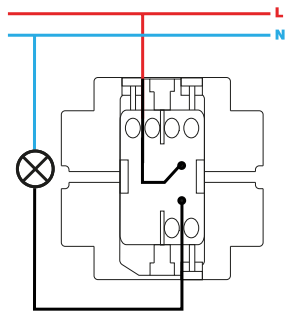

Interruptor unipolar / Single-pole switch
XXXX101-XXX

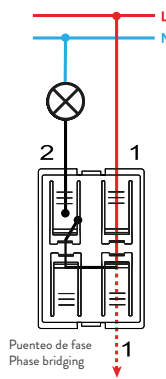

Interruptor unipolar / Single-pole switch
7700101-039

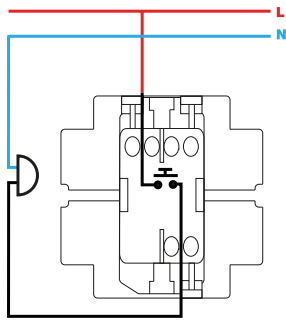

Pulsador / Push button switch
XXXX150-XXX

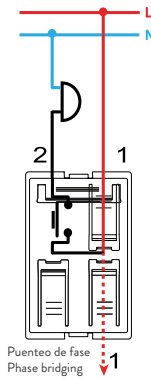

Pulsador / Push button switch
7700150-039

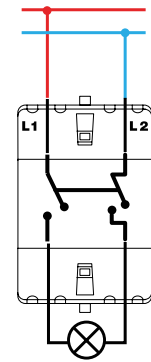

Interruptor bipolar / Double pole switch
XXXX133-XXX

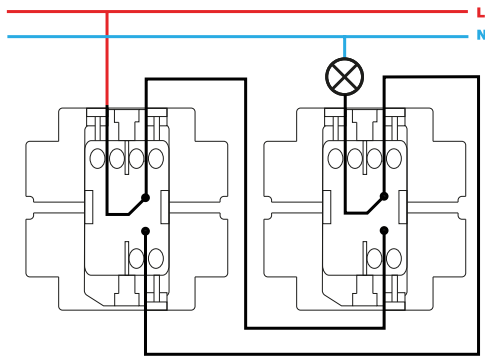

Conmutador / 2-way switch
XXXX201-XXX

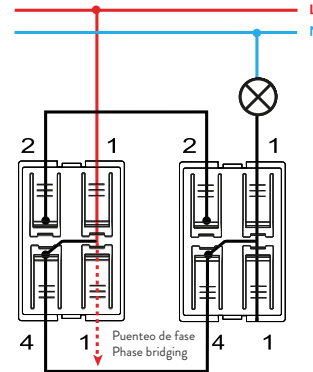

Conmutador / 2-way switch
7700201-039

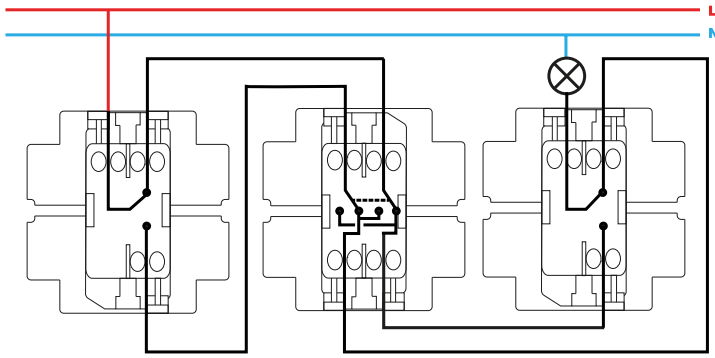

Conmutador cruce / Intermediate switch
XXXX251-XXX

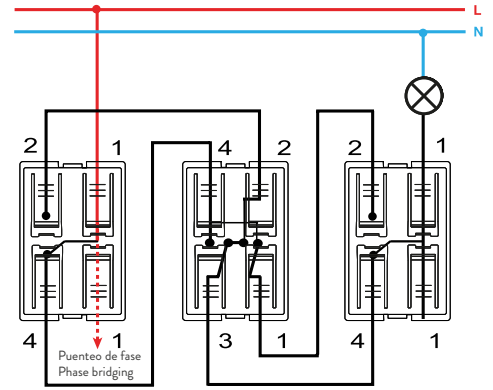

Conmutador cruce / Intermediate switch
7700251-039

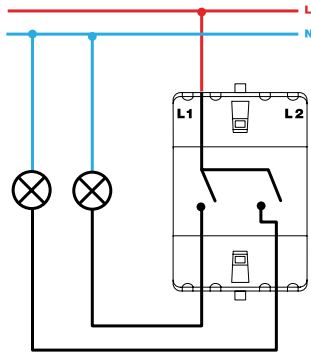

Grupo 2 interruptores / 2 switches group
XXXX398-XXX

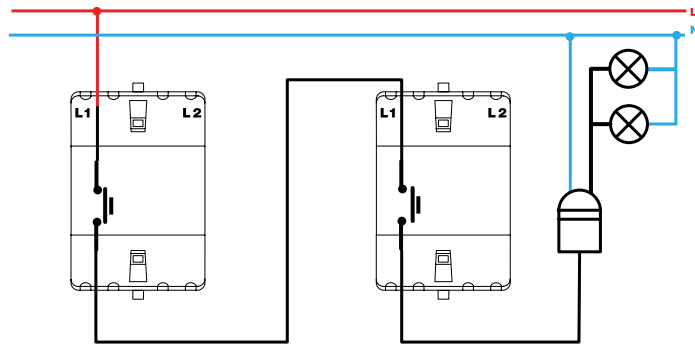

Pulsador desconexión / Push button disconnection switch
XXXX152-XXX

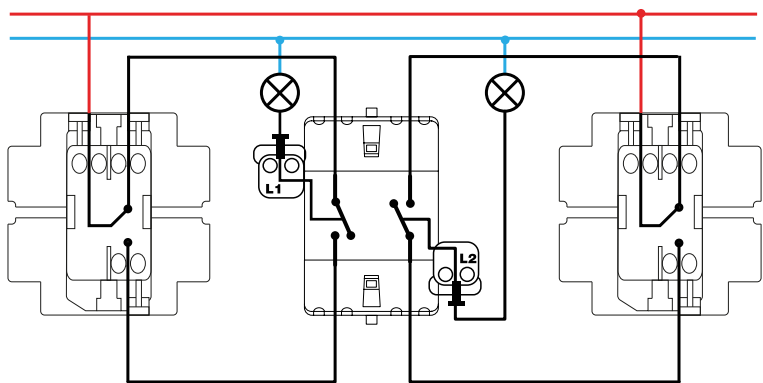

Grupo dos conmutadores / 2-way switches group
XXXX397-XXX

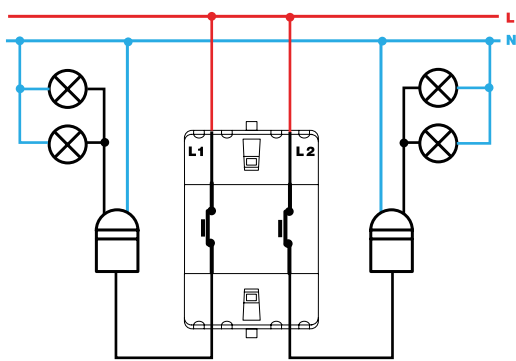

Grupo de pulsadores desconexión / Push button switch
desconexion group XXXX395-XXX

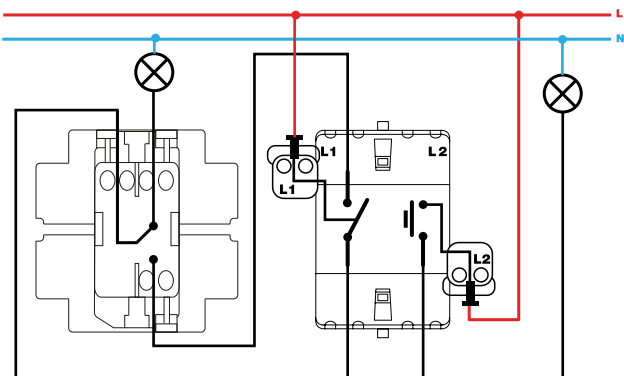

Grupo conmutador y pulsador / 2-way and push button switch group
XXXX301-XXX

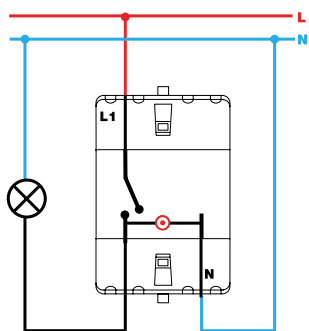

Interruptor unipolar / Single-pole switch
XXXX102-XXX

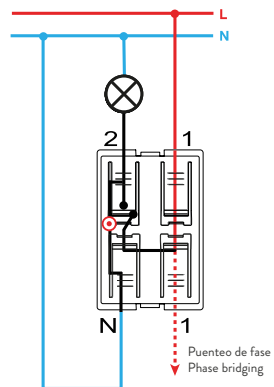

Interruptor con piloto / Push button pilot switch
7700112-039

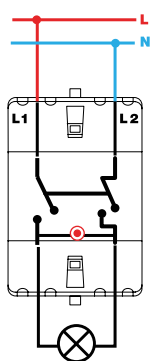

Interruptor bipolar / Double pole switch
XXXX134-XXX

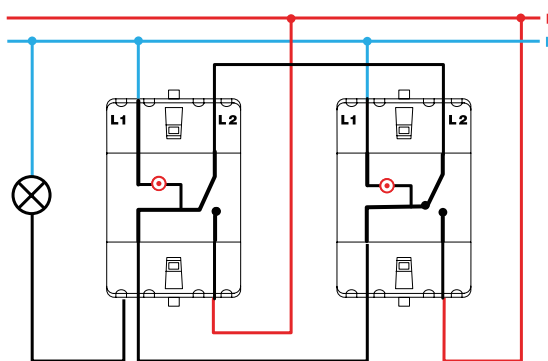

Conmutador / 2-way switch
XXXX202-XXX

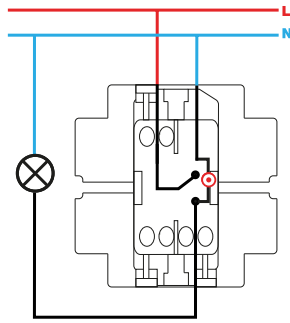

Interruptor unipolar con luminoso / Single-pole switch with light
XXXX104-XXX

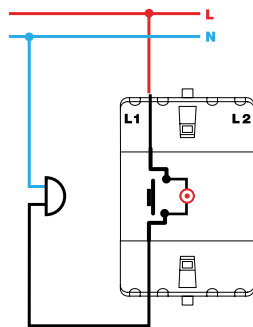

Pulsador con luminoso / Push button switch with light
XXXX160-XXX

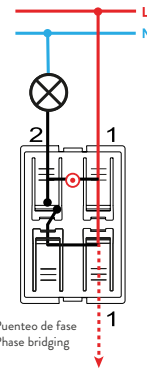

Pulsador con luminoso / Push button switch with light
7700160-039

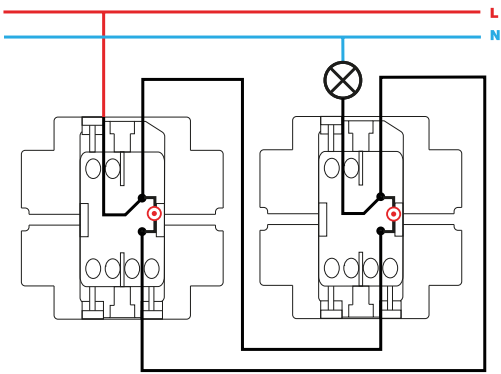

Conmutador con luminoso / 2-way switch with light
XXXX204-XXX

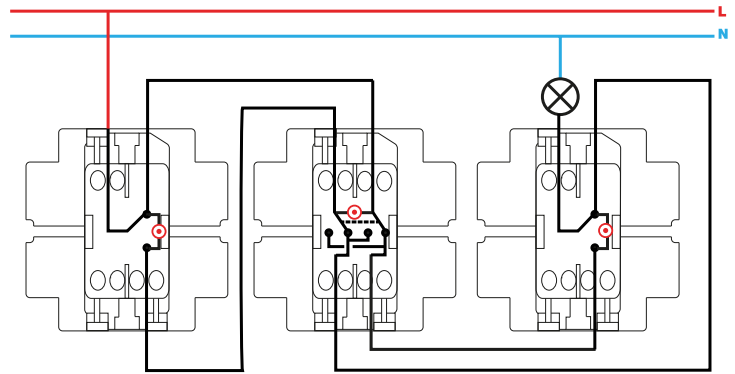

Conmutador cruce con luminoso / Intermediate switch with light
XXXX254-XXX