

Conjunto semi-montado de 2 conmutadores 10 AX 250~ con sistema de embornamiento rápido blanco Simon 82 Concept

REF. 8200397-030



INFORMACIÓN BÁSICA

ACABADO

Blanco

COMPATIBILIDAD

Marcos Simon 82 Detail, Simon
82 Nature y Simon 82

EMBALAJE

Flowpack

CLASE ETIM

EC001590

INFORMACIÓN TÉCNICA

NORMATIVA

GARANTÍA

3 años

REGULACIONES

Dir. 2014/35/UE LVD | Dir. 2011/65/UE RoHS + post. mod. EN 60669-1:2018 | EN IEC 63000:2018

INFORMACIÓN LOGÍSTICA

CÓDIGO EAN UNITARIO	PESO BRUTO EMBALAJE UNITARIO	LONGITUD EMBALAJE
8421053279861	0.083	223
ALTURA EMBALAJE UNITARIO	PESO NETO DEL PRODUCTO	UNIDAD DE MEDIDA EMBALAJE
0	0.083	MMT
ANCHO EMBALAJE UNITARIO	UNIDAD DE PESO EMBALAJE UNITARIO	VOLUMEN EMBALAJE
0	KGM	1.518
LONGITUD EMBALAJE UNITARIO	EAN EMBALAJE	UNIDAD DE VOLUMEN EMBALAJE
0	8421053228920	DMQ
UNIDAD DE MEDIDA EMBALAJE UNITARIO	UDS. CONTENIDAS EMBALAJE	PESO BRUTO EMBALAJE
MMT	5	0
VOLUMEN EMBALAJE UNITARIO	ALTURA EMBALAJE	PESO NETO EMBALAJE
0	82	0.415
UNIDAD DE VOLUMEN EMBALAJE UNITARIO	ANCHO EMBALAJE	UNIDAD DE PESO EMBALAJE
MMQ	83	KGM

MECANISMOS SIMON 31, 75, 77, 82 Y 88

Mecanismos básicos / Basic switches

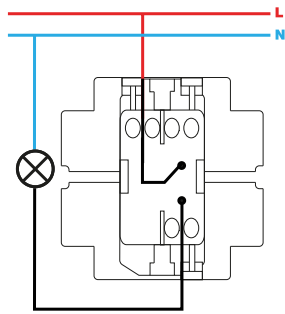

Interruptor unipolar / Single-pole switch
XXXX101-XXX

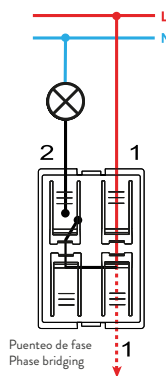

Interruptor unipolar / Single-pole switch
7700101-039

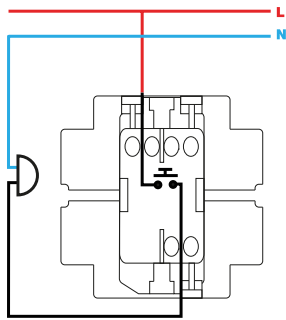

Pulsador / Push button switch
XXXX150-XXX

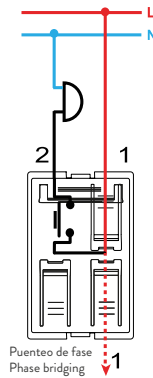

Pulsador / Push button switch
7700150-039

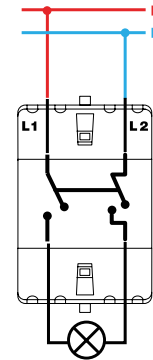

Interruptor bipolar / Double pole switch
XXXX133-XXX

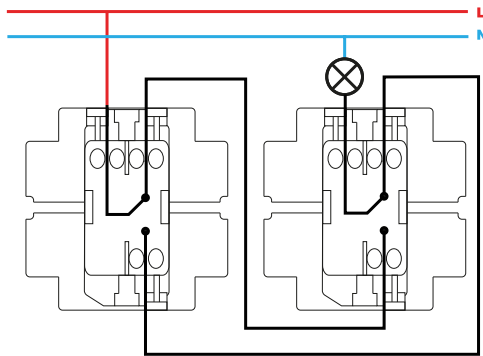

Conmutador / 2-way switch
XXXX201-XXX

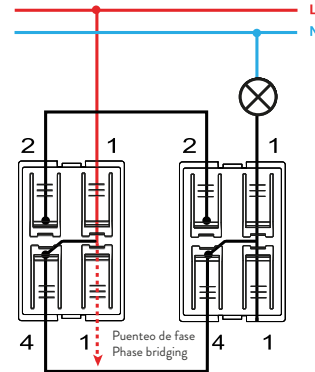

Conmutador / 2-way switch
7700201-039

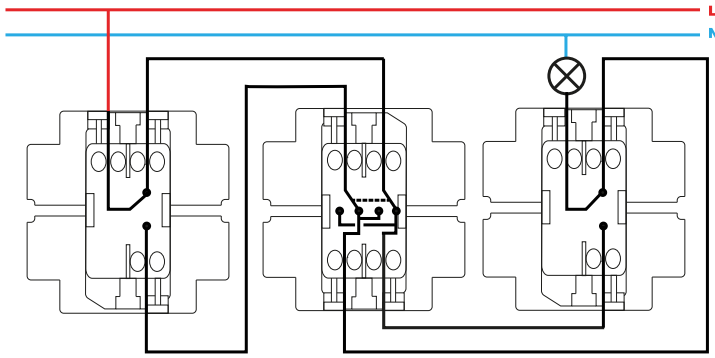

Conmutador cruce / Intermediate switch
XXXX251-XXX

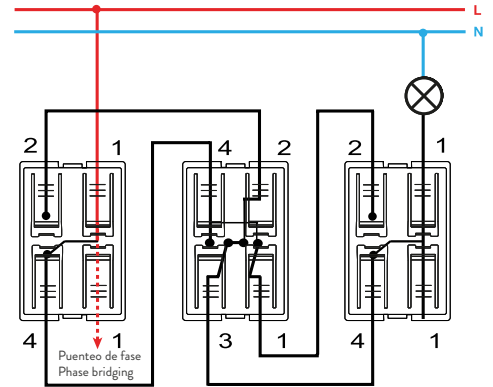

Conmutador cruce / Intermediate switch
7700251-039

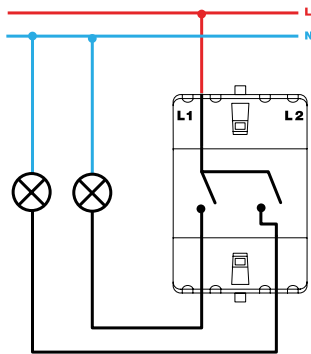

Grupo 2 interruptores / 2 switches group
XXXX398-XXX

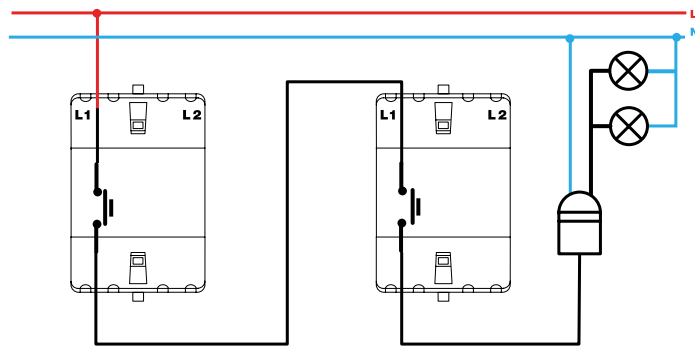

Pulsador desconexión / Push button disconnection switch
XXXX152-XXX

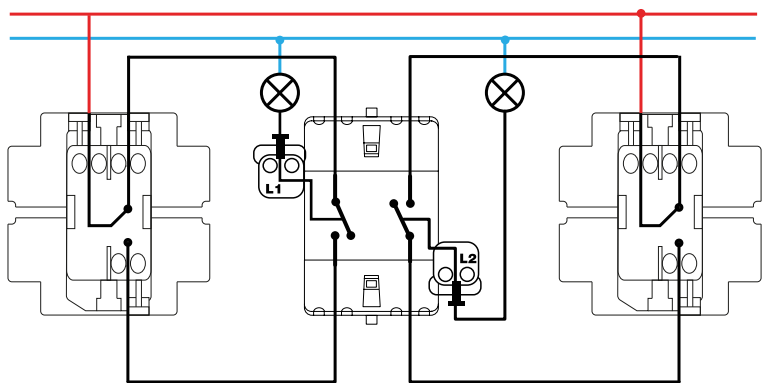

Grupo dos conmutadores / 2-way switches group
XXXX397-XXX

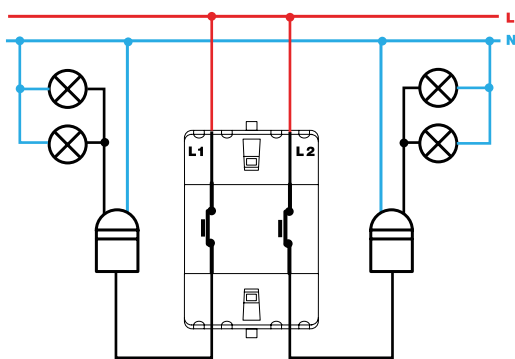

Grupo de pulsadores desconexión / Push button disconnection group
XXXX395-XXX

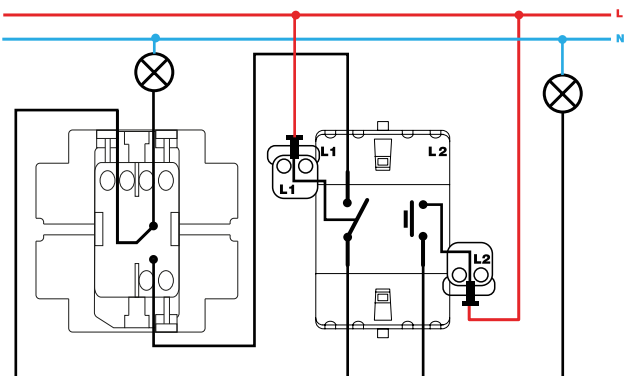

Grupo conmutador y pulsador / 2-way and push button switch group
XXXX301-XXX

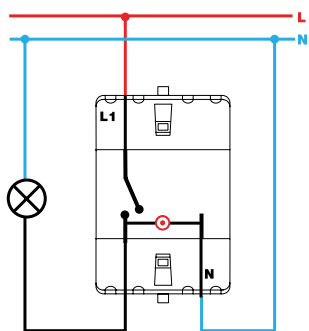

Interruptor unipolar / Single-pole switch
XXXX102-XXX

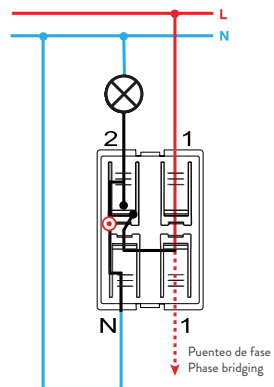

Interruptor con piloto / Push button pilot switch
7700112-039

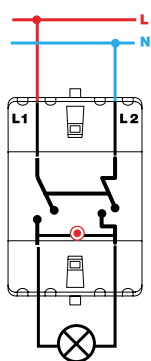

Interruptor bipolar / Double pole switch
XXXX134-XXX

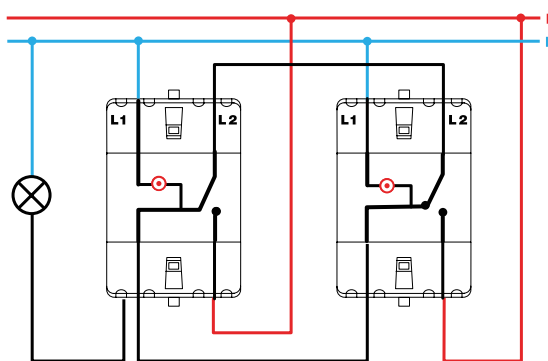

Conmutador / 2-way switch
XXXX202-XXX

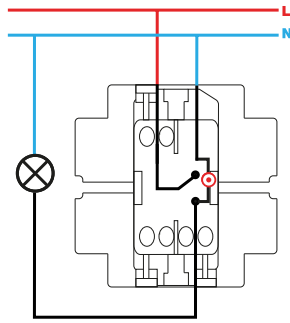

Interrupor unipolar con luminoso / Single-pole switch with light
XXXX104-XXX

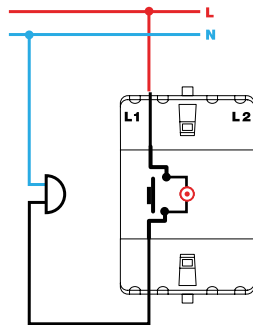

Pulsador con luminoso / Push button switch with light
XXXX160-XXX

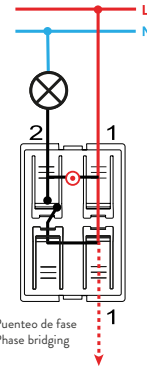

Pulsador con luminoso / Push button switch with light
7700160-039

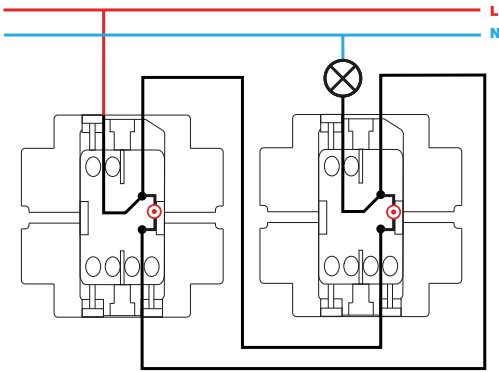

Conmutador con luminoso / 2-way switch with light
XXXX204-XXX

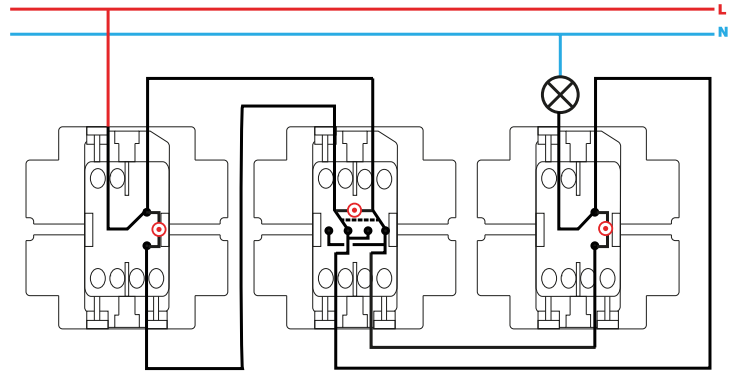

Conmutador cruce con luminoso / Intermediate switch with light
XXXX254-XXX