



LuxLite

— LED Solutions —

HIGH QUALITY ENERGY-SAVING
LED LIGHTING SOLUTIONS

V3.0



LuxLite
— LED Solutions —





Luxlite is a manufacturer of high quality LED lighting & supplies exclusively to the electrical wholesale market. At our Head Office in Lancashire, we have an extensive range of products available for next day delivery on all orders placed by 3:00pm.

We pride ourselves on excellent customer service through our fantastic, experienced sales team, ensuring long term relationships with customers. Our customers can rely on us for a friendly, professional service with great product knowledge and technical support.







About LED

LEDs are “directional” light sources, which means they emit light in a specific direction, unlike incandescent and compact fluorescent lamps, which emit light and heat in all directions. For this reason, LED lighting is able to use light and energy more efficiently in many applications.

LEDs are extremely energy efficient and consume up to 90% less power than incandescent lamps. Since LEDs use only a fraction of the energy of an incandescent light there is a dramatic decrease in power costs.

Also, money and energy is saved in maintenance and replacement costs due to the long LED lifespan.

Compared to traditional incandescent, energy-efficient light lamps such as halogen incandescent, compact fluorescent lamps (CFLs), and light emitting diodes (LEDs) have the following advantages: Typically use about 25%-80% less energy than traditional incandescent, saving you money. The electricity used over the lifetime of a single incandescent bulb costs 5 to 10 times the original purchase price of the lamp itself. Light Emitting Diode

Brightness		220+	400+	700+	900+	1300+
	Halogen	18W	28W	42W	53W	70W
	LED	2W	4W	7W	9W	13W
	CFL	6W	9W	12W	15W	20W
	Standard	25W	40W	60W	75W	100W

(LED) and Compact Fluorescent Lights (CFL) bulbs have revolutionized energy-efficient lighting. CFLs are simply miniature versions of full-sized fluorescents.

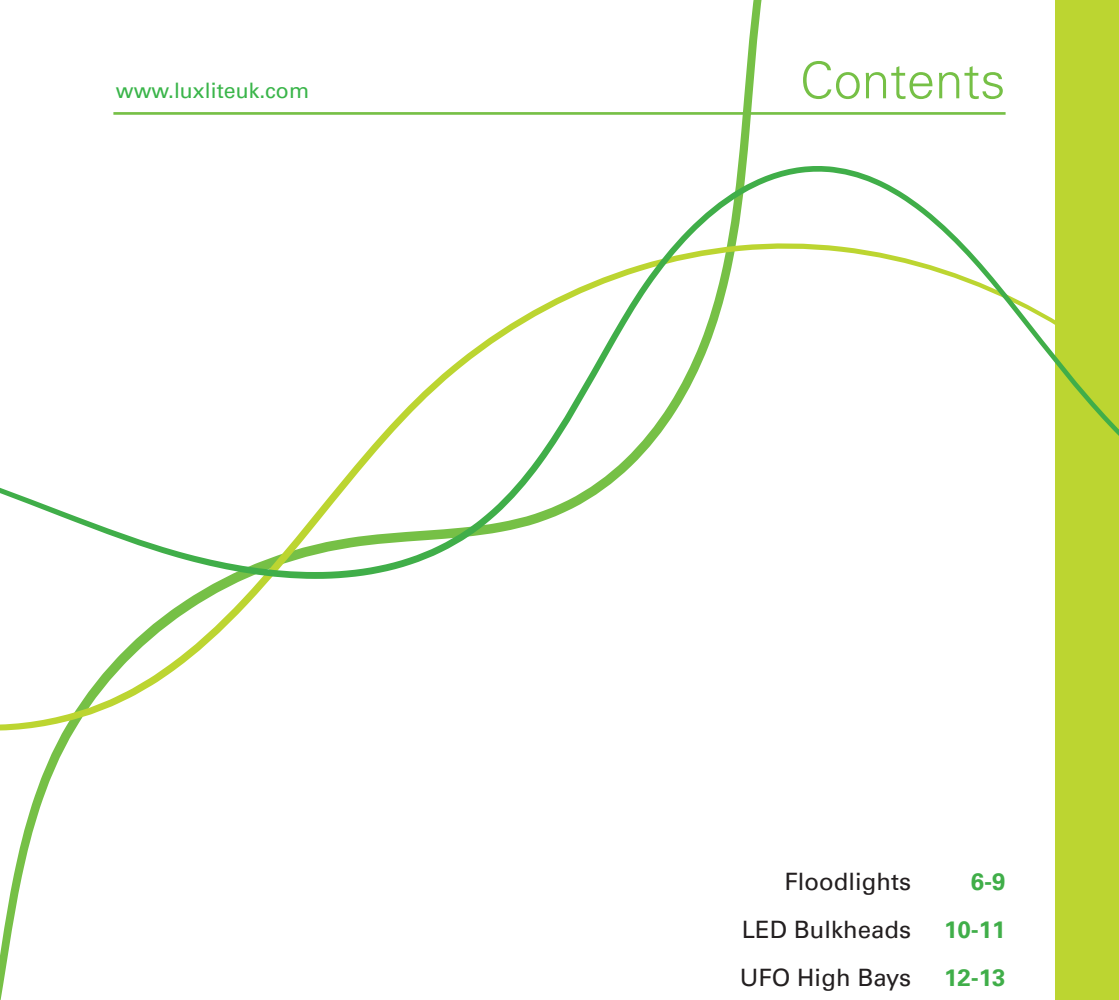

Floodlights	6-9
LED Bulkheads	10-11
UFO High Bays	12-13
UFO Low Bays	14
LED Corn Lamps	15
P-Series ECO Slim LED Batten	16
Pop Pack LED Batten	17-19
E-Series NCF's	20-21
Circular LED Panel Lights	22
Borderline LED Panel	23-24
LED Downlights	24-26
Emergency Lighting	27-30

Our Eco range of driverless, super slim, stylish yet robust floodlights offer a one stop solution for any floodlighting application. High impact, IK07 toughened glass, 1m H05RN-F cable, 2 years warranty and a range of plug-in attachments. PIR, Photocell.

Code	Watts	Colour	Lumens	Size (mm)	IP Rate
10WFLCW-AC	10W	4500K	800	103x83x23	IP65
10WFLDL-AC	10W	6500K	800	103x83x24	IP65

Code	Watts	Colour	Lumens	Size (mm)	IP Rate
20WFLCW-AC	20W	4500K	1600	159x121x25	IP65
20WFLDL-AC	20W	6500K	1600	159x121x25	IP65

Code	Watts	Colour	Lumens	Size (mm)	IP Rate
30WFLCW-AC	30W	4500K	2400	159x121x25	IP65
30WFLDL-AC	30W	6500K	2400	159x121x25	IP65

Code	Watts	Colour	Lumens	Size (mm)	IP Rate
50WFLCW-AC	50W	4500K	4000	205x159x29	IP65
50WFLDL-AC	50W	6500K	4000	205x159x29	IP65



ATTACHMENTS FOR 10W- 30W AC LED FLOODLIGHTS

Code	Watts	Size (mm)	IP Rate
FLPIR-AC	10W-30W	60x42x29	IP65
FLPC-AC	10W-30W	60x42x30	IP65

Code	Watts	Colour	Lumens	Size (mm)	IP Rate
100WFLCW-AC	100W	4500K	9,000	269x210x33	IP65
100WFLDL-AC	100W	6500K	9,000	269x210x33	IP65

Code	Watts	Colour	Lumens	Size (mm)	IP Rate
150WFLCW-AC	150W	4500K	13,500	380x279x38	IP65
150WFLDL-AC	150W	6500K	13,500	380x279x38	IP65

Code	Watts	Colour	Lumens	Size (mm)	IP Rate
200WFLCW-AC	200W	4500K	18,000	380x279x38	IP65
200WFLDL-AC	200W	6500K	18,000	380x279x38	IP65

Code	Watts	Colour	Lumens	Size (mm)	IP Rate
300WFLDL-AC	300W	6500K	27,000	445x335x48	IP65

**All of our driverless AC LED floodlights have min/max operating temperatures of -25°C / +50°C*



- A solar light that does not need wiring or electricity and is easy to install.
- The 10W & 20W lights have a photocell and radar sensor and the 30W light has a Microwave sensor so they will automatically switch the light on when people come in at night.
- There is a switch on the side, pls turn on. Then the light can work automatically.
- The 30W battery can be replaced by yourself.

	10W	20W	30W
Electrical Data			
Wattage	10W	20W	30W
Battery Capacity	3.7V 2.6AH	3.7V 5.2AH	3.7V 6AH
Waterproof	IP65	IP65	IP65
Surface Colour	Black	Black	Black
Optical Data			
Colour Temperature	6500K	6500K	6500K
Lumen	1300lm	2000lm	3000lm
RA	>80	>80	>80
PF	>0.9	>0.9	>0.9
Lighting Area	200SQM	250SQM	300SQM
Other			
Solar Panel	5V 1.5W	5V 3.5W	9V 4W
Working Temperature	-20°C - 50°C	-20°C - 50°C	-20°C - 50°C
Size	122x90x32mm	173x97x32mm	190x107x30mm



PRO MARINE- COASTAL- ANTI CORROSIVE SYMMETRICAL FLOODLIGHT

Our range of high performance, marine grade, anti-corrosive floodlights are perfect for coastal areas and corrosive environments such as swimming pools.

Constructed out of high quality, die-cast aluminium, with surface electrophoresis, corrosion proof treatment and stainless-steel bracket.

Pre flexed with 1m of H05RN-F rubber cable and breathable gland to prevent internal moisture accumulation.



Part Code	Wattage	Size (mm)	Input Voltage	CCT	Lumens	Beam Angle
100WPMFL-6K	100W	369x278x52	85-277V AC	6000K	14,000	90
200WPMFL-6K	200W	445x392x56	85-277V AC	6000K	28,000	90



We offer a wide range of LED surface bulkhead fittings, which are available in various configurations including standard, microwave, emergency, microwave and emergency and corridor function. They are all IP65, and boast up to 1600 lumens. These fittings can be wall or ceiling mounted and have knockouts on the base / side of the fitting.

MINI LED POLO FITTING / 2D REPLACEMENT

Code	Watts	Description	Lumens	Size (mm)
CSL10-45	10W	Mini 4500K Polo fitting Standard	850	271x92
CSL10-BEZPC	N/A	Polished Chrome Bezel for CSL10 Polo fitting	N/A	N/A



LED POLO FITTING / 2D REPLACEMENT

Code	Watts	Description	Lumens	Size (mm)
CSL16-45		4500K Polo fitting Standard	1600	320x82.5
CSL16-45EM		4500K Polo fitting Emergency		
CSL16-MWS		Plug and Play Microwave Sensor with Corridor Function	N/A	N/A
CSL16-PCBEZ	N/A	Polished Chrome Bezel for CSL16 Polo fitting	N/A	N/A



CHAMELEON CCT BULKHEAD - 3000K / 4000K / 6000K

Code	Watts	Description	Lumens	Size (mm)
CBL18-CCT	18	18W CCT Bulkhead	1800	282x83
CBL18-CCT-M		18W CCT Bulkhead Microwave		
CBL18-CCT-EM		18W CCT Bulkhead 3H Emergency		
CBL18-CCT-MEM		18W CCT Bulkhead Microwave & 3H Emergency		
CBLCCT-BLK-BEZ		Chameleon Round Black Bezel		
CBLCCT-BLK-GRI		Chameleon Black Grill Bezel		
CBLCCT-BLK-HMB		Chameleon Black Half Moon / Eye Lid Bezel		



9W WALL / CEILING LIGHT

Code	Watts	Colour	Lumen	Voltage	Size (mm)
LUX-BH9W	9W	4500K	700	180-240V	265x115x91
LUX-BH9WPIR					

**Available in Black or White*



PRO SELECT, K3 range of UFO high bays are wattage selectable, meaning you can reduce your SKU's and if the light output turns out to either not be enough, or is too bright, you can adjust this via a simple switch on the fitting. All K3 fittings come with a high-quality LED driver and Lumiled LED chip set, offering exceptional 160lm/w performance. The fittings are IP65, IK08, 1-10V Dimmable as standard and come with a polycarbonateTP(a) diffuser. You can also upgrade this fitting to Microwave, using our plug & play sensor, or Emergency, using one of our IP65 Emergency Remote packs.

Code	Watts	Colour	Lumens	Beam	Size (mm)
UFO100W-65K3	60/80/100W	6000K	9,600- 16,000	90	235x110
UFO200W-65K3	100/150/200W		16,000- 32,000		305x115

**Plug & Play Microwave Sensor & Remote sold separately*

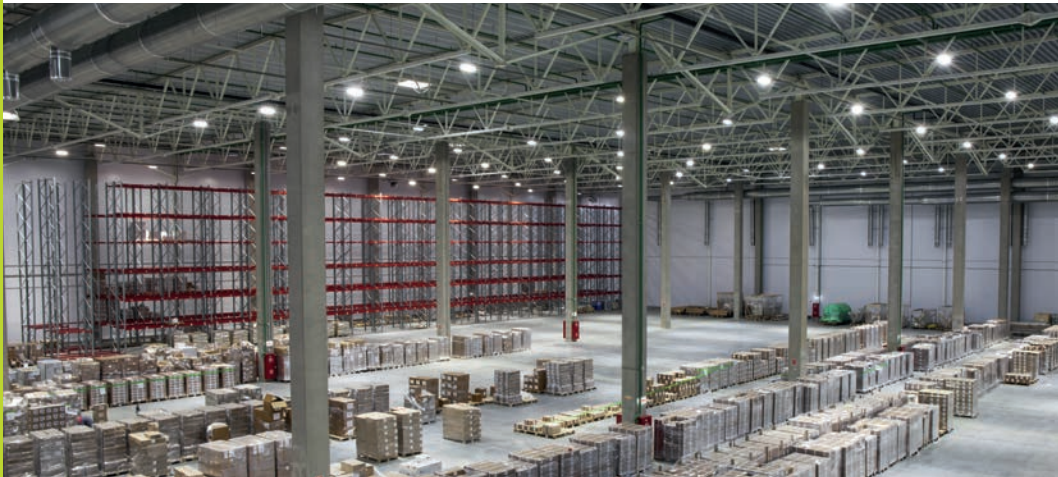



C/W Meanwell Driver & Opal Sheet

Our linear LED Lowbays are available in both 120W & 180W outputs and boast an impressive 140 lumen per watt output. Using only the highest quality diodes, and premium Meanwell drivers, the product truly is built to last.

Emergency and microwave options are available off the shelf and dimmable conversions also available, (0/1-10V)

Surface mount, or suspension (Suspension kits sold separately)

Code	Watts	Colour	Lumen	Beam Angle	LxWxH (mm)
LB120W-65N	120W	6500K	16,200	120°	1198x285x65
LB180W-65N	180W		24,300		1198x285x66

** For emergency versions add -EM or Microwave versions add -M. Spare opal sheets are available.*



BEFORE

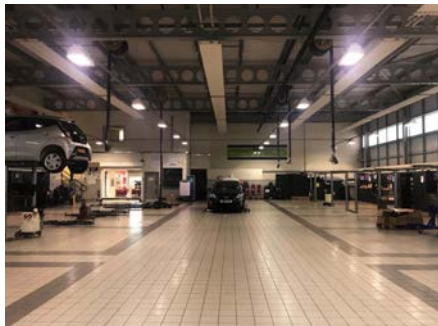

AFTER

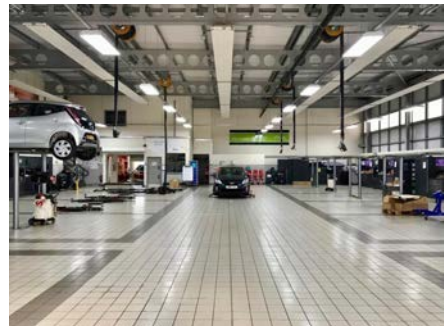

Our brand new range of Pro / Select LED corn lamps are ideal for replacing SON or HQI (Metal Halide) lamps in low bays and high bay fittings.

20W - 120W wattage selectable perfect for multiple applications and reducing SKU's.

Aluminium heat sink for superior heat dissipation, removing the need for noisy fans.



Code	Watts	Colour	Lumens	Cap	Size (mm)
E27CL20/30W-45	20 & 30	4500K	1,900-2,800	ES	60x162
E27CL20/30W-65		6500K			
E27CL40/60W-45	40 & 60	4500K	3,900-5,600	ES	60x223
E27CL40/60W-65		6500K			
E40CL80/120W-45	80 & 120	4500K	8,680-12,400	GES	88x286
E40CL80/120W-65		6500K			
E40CL100W-45	100	4500K	10,850	GES	88x286
E40CL100W-65		6500K			
E40CL150W-45	150	4500K	15,500	GES	113x272
E40CL150W-65		6500K			



LED Batten Introduction

FEATURES:

1. Input Voltage: 165-265V AC;
2. Frequency: 50/60Hz
3. 2ft to 6ft from 18W to 55W
4. Light effect reach to 110LM/W
5. ColourTemp 2700K / 4700K / 6500K
6. CRI >80Ra 120° beam angle
7. LED chips: SMD2835
8. Polycarbonate base and diffuser
9. Easy installation with quick release brackets
10. Suspension kits available
11. Surface mounted or suspended
12. Up energy saving to 85%
13. Packing: colour inner box+brown carton
14. IP20 only indoor use
15. Ambient temperature: -25°C ~ +45°C

APPLICATIONS:

Suitable for supermarkets, commercial buildings, cabinets, store rooms, workshops, garages, car parks and warehouses etc.



Code	Power	Length	Lumens	Flicker or Not	LxWxH (mm)
LUX-LEDFTG 2FT18W-CCT	18W	2FT	1,980	Flicker Free	600x75x23
LUX-LEDFTG 3FT28W-CCT	28W	3FT	3,080		900x75x23
LUX-LEDFTG 4FT36W-CCT	36W	4FT	3,960		1200x75x23
LUX-LEDFTG 5FT45W-CCT	45W	5FT	4,950		1500x75x23
LUX-LEDFTG 6FT55W-CCT	55W	6FT	6,050		1800x75x23



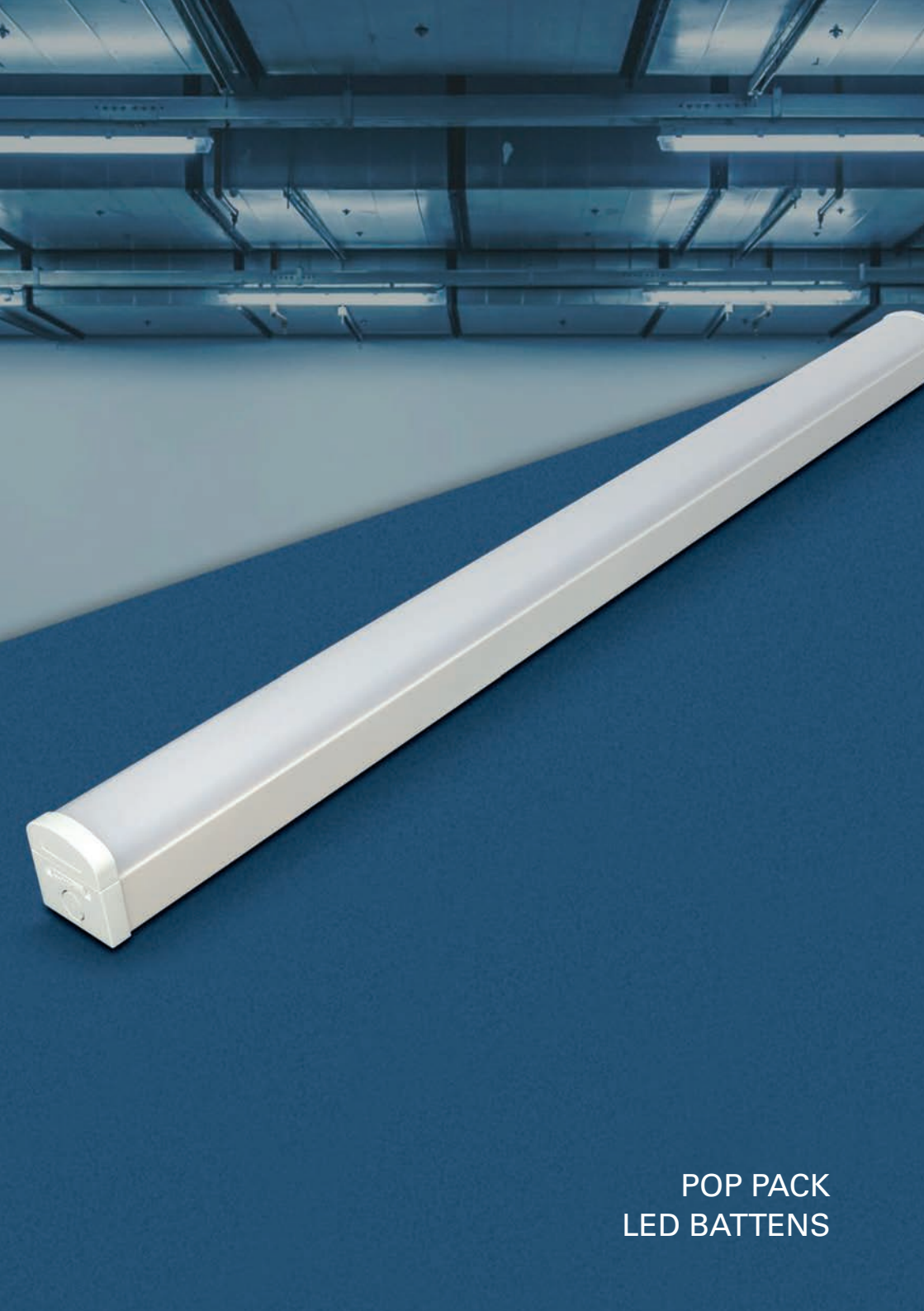

POP PACK
LED BATTENS

Offering easy installation and zero maintenance, whilst boasting 120lm/w.

Available in a 4, 5 or 6ft option, single or twin and 4500K or 6500K, this LED batten fitting really does offer an ideal alternative for replacing T5 and T8 fluorescent fittings.

Emergency and dimmable options also available.



TECHNICAL DATA

- Input Voltage: AC175-265V 50/60Hz2
- Operation Voltage: DC36-42V
- Power Factor: PF>0.95
- Lumen Maintenance @6000h: >80%
- Switching cycle before failure: 100,000
- IP Rating: IP20
- Life Span: 50,000 hours
- Warranty: 5
- Operation Temperature: -15°C- +50°C
- Storage Temperature: -25°C- +55°C

SPECIFICATIONS

Model Number	LUX-PPB4FT20W	LUX-PPB4FT40W	LUX-PPB5FT30W	LUX-PPB5FT60W	LUX-PPB6FT40W	LUX-PPB6FT70W
Rated Voltage	175-265V					
Frequency	50/60Hz					
Rated Power	20W	40W	30W	60W	40W	70W
Lumen	2400lm	4800lm	3600lm	7200lm	4800lm	8100lm
Protection Class	I					
Protection	IP20					
Size	1200*72*72.5mm		1500*72*72.5mm		1800*72*72.5mm	

** For alternative options: Cool White - 4500K add / -45, Daylight - 6500K add / -65, Emergency add - EM, Microwave and Emergency add - MEM*



PRO SELECT ALL IN ONE - POP PACK LED BATTEN

Our PRO SELECT, All-in-One, 5FT & 6FT Multi Pop Pack batters offer you complete flexibility. Offering not only 3 CCT via switch, but the option of 4 separate wattages to suit any application, and single & twin output options.

What is more, this fitting also comes with a tool free Microwave sensor plug-in, and Plug and Play Emergency pack, making this fitting even more versatile. (Sold Separately)*

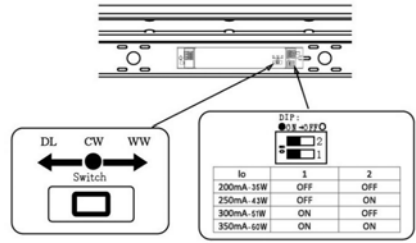

Description	Details- 5ft	Details- 6ft
Rated Power	25W / 30W / 40W / 50W	35W / 45W / 56W / 70W
Product Size L*W*H*(mm)	1475*62*70	1775*62*70
Input Voltage	220-240V~ 50/60Hz	220-240V~ 50/60Hz
PF	>0.9	>0.9
Lumen (LM)	3,750 - 7,500	5,250 - 10,500
Efficiency (LM/W)	150 (4000K)	150 (4000K)
Beam Angle	120°	120°
CCT (K)	3000K / 4000K / 6000K	3000K / 4000K / 6000K

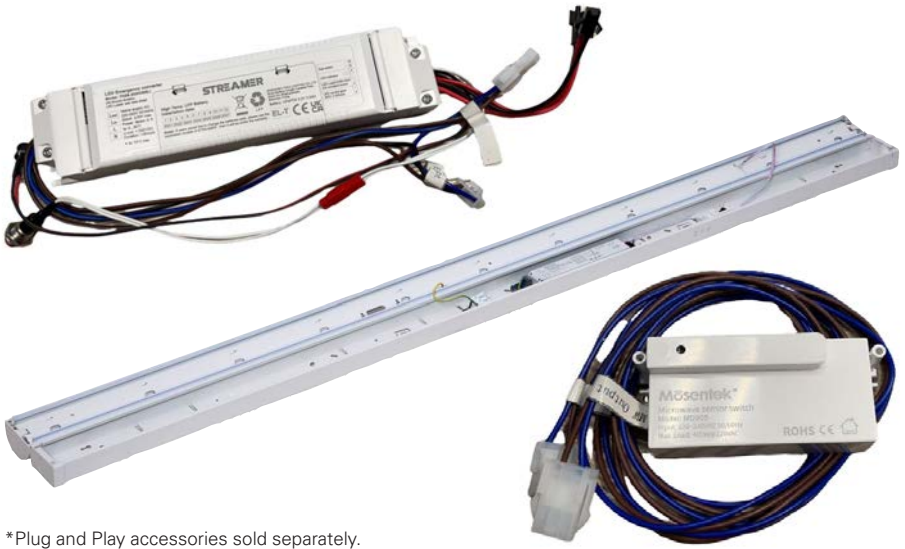

*Plug and Play accessories sold separately.

NCF Introduction

FEATURES:

1. Input Voltage: 220-240V AC
2. Frequency: 50/60Hz
3. IP Rating: IP65 Class: I
4. Housing and Diffuser PC, high impact resistant, IK08, glow wire testing 850 degrees
5. Gear tray: metal plate for heat dissipation
6. Gel gasket to ensure waterproof and dust-proof
7. Cable gland: PG13.5 waterproof tightening gland
8. Fixation: stainless mounting brackets (2pcs)
9. Ambient Temperature: -25°C ~ +45°C
10. UKCA, CE, ROHS approved



OPTIONS:

- Emergency kits
- Dali function
- Dimmable function (0-10V)
- Microwave sensor

Code	Power	Length	Lumen Output	Diffuser	CCT	Material	IP Code	IK
LUX-5FT30W NCF-65E	30W	5FT	3,750	Opal	6500K	PC base + PC diffuser	IP65	IK08
LUX-5FT50W NCF-65E	50W		6,500					
LUX-6FT45W NCF-65E	45W	6FT	4,950	Opal	6500K	PC base + PC diffuser	IP65	IK08
LUX-6FT70W NCF-65E	70W		7,800					

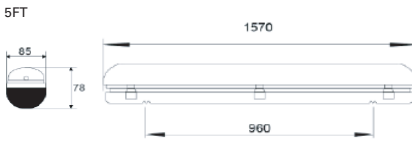

Our PRO SELECT, All-in-One, 4FT, 5FT & 6FT NCF, Anti-Corrosive fittings give you and the installer complete flexibility.

Offering not only 3 CCT via switch, but the option of 4 separate wattages to suit any application, and single and twin output options.

What is more, this fitting also comes with a tool free Microwave sensor plug-in, and Plug & Play Emergency pack, making this fitting even more versatile. (Sold Separately)*

Description	Details - 4ft	Details - 5ft	Details - 6ft
Rated Power	18 / 24 / 30 / 36W	25 / 30 / 40 / 50W	35 / 48 / 58 / 70W
Product Size	1200 x 96 x 81	1500 x 96 x 81	1800 x 96 x 81
Input Voltage	220-240V	220-240V	220-240V
PF	>0.9	>0.9	>0.9
Lumen	2,700 - 5,400	3,750 - 7,500	5,250 - 10,500
Efficiency (LM/W)	150	150	150
Beam Angle	120°	120°	120°
CCT (K)	3000/4000/6000K	3000/4000/6000K	3000/4000/6000K

*Stock due July 2024

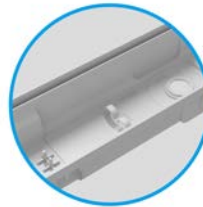

Built-in cable Restraints

IP 66 Anti-Corrosive Fitting

150
LM / W



Tool less for through wiring



Quick plug in for Driver



Quick plug in for Emergency pack



Quick plug in for Microwave Sensor



Our brand-new range of Ultra slim, 3 CCT circular LED panels lights are perfect for recessed applications in the home, office, or commercial projects.

Using the latest in DOB technology and colour selectable via switch on the back of the fitting.

Available as standard (non-dim) and emergency.

Code	Watts	Colour	Lumen	Cut Out (mm)	Depth (mm)
LUX-ECPL9-CCT	9W	2700/4500/6000K	765	105mm	26mm
LUX-ECPL18-CCT	18W	2700/4500/6000K	1,530	155mm	26mm
LUX-ECPL24-CCT	24W	2700/4500/6000K	2,040	205mm	26mm



CCT BORDERLINE LED PANEL

- 3CCT
- LED type: SMD
- CRI: Ra>80
- Beam angle: 120
- Voltage: DC28-42V
- Emergency versions available
- Complete with plug in driver
- DALI dimmable option available and mains dimmable versions are available



Code	Watts	Colour	Lumen	Size (mm)
LUX-BLP40W664-CCT	40W	2700K/4000K/6000K	4,000	595x595x11



All Luxlite LED panels now come as TP(a) as standard.

Our new and improved 600x600 & 1200x600 Back-Lit LED panels are also wattage & colour selectable, making this panel one of the most versatile on the market.

Both 600x600 & 1200x600 panels, come complete with a Plug & Play, tool-free LED driver with loop in-loop out terminals for ease and speed of installation.

Emergency versions are available and can be converted with ease using our plug and play universal 3-hour emergency pack. Dimmable options (DALI or Mains Dim).

Supplied with a 5 Year warranty as standard.

A 1-year on-site option is available if required. Terms apply and registration required.

Code	Watts	CCT	Lumen	Size (mm)
LUX-BL2840W664-CCT	28 / 32 / 36 40	3000 / 4000 / 6000	2,968 - 4,240	595x595x28
LUX-BL60W126-CCT	48 / 52 / 56 / 60	3000 / 4000 / 6000	5,088 - 6,360	1195x595x28
EMGPCK-PO4	Universal Emergency Pack for ALL Luxlite LED Panels (SELFTEST OPTION)			

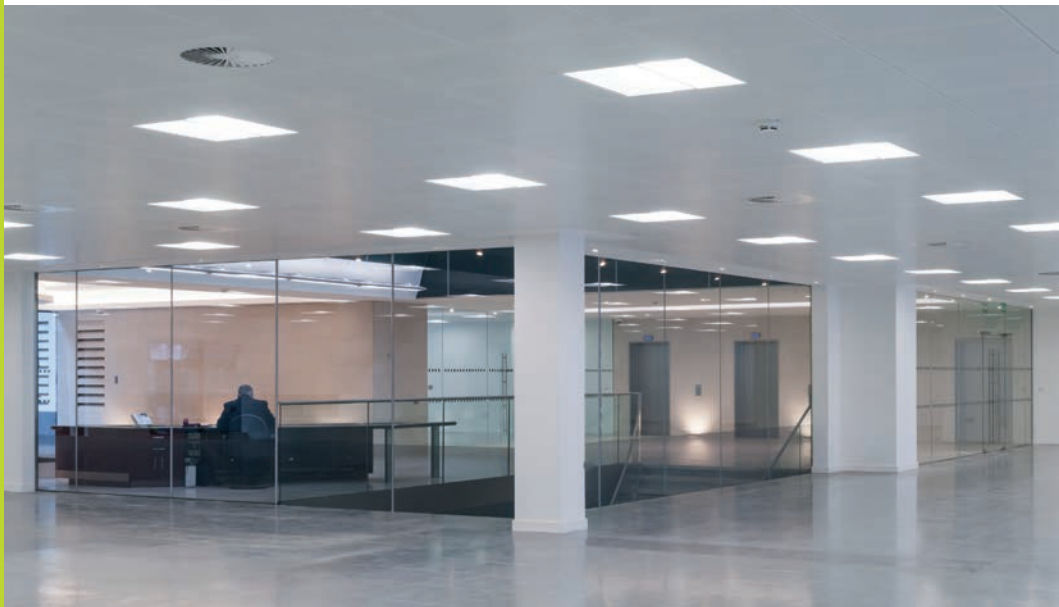

The KINDLE2- 4CCT is IP65 rated from the front and suitable for bathroom zones 1 & 2. This product is suitable for fire rated installations, Part L compliant of UK building regulations, Part B compliant BS476, Parts 21 and 22. Suitable for 30 minute 600mm/15mm single layer standard wallboard, 60 minute 600mm/12.5mm twin layer fireboard and 90 minute 450mm/15mm twin layer fireboard ceilings. The KINDLE2-CCT is also suitable for 30min fire rated timber ceilings and suspended ceilings, as well as Metal Web and I-Joists.

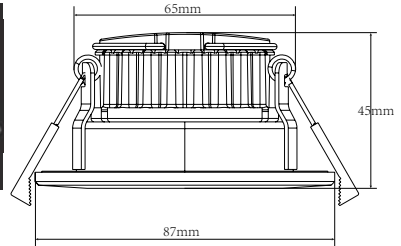
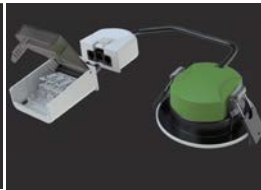

Electrical & Output Data

Voltage	200-265V AC	Bezel Finish	White/Black/Brushed/Polished/Brass/Anthracite
Lampless	Built in LED	CRI	>80Ra
Wattage	7W	Connection	Push on
Lumens	700lm	Beam Angle	60°
Colour Temperature	2700K/3000K/4000K/6000K	Dimmable	Yes, for best results use a varilight V-COM dimmer
Cut Out	70mm	Driver	Non-Detachable
Minimum Void	40mm		



KINDLE ECO

Fire Rated LED Downlight
6W, 540LM, 3 CCT, Triac Dimming



FEATURES & BENEFITS

- Full fire rate tested 30, 60, 90 mins
- I-Joist and Web
- CCT selectable by DIP switch
- Flicker free, IP65 rated at front
- Separate junction box with loop in and loop out terminals
- White, Black, Brushed and Polished Chrome Bezel options

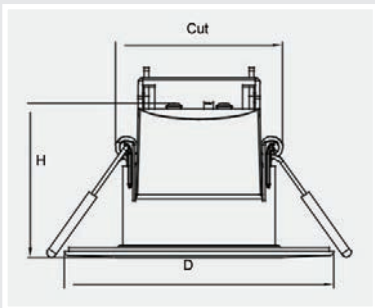

General Information

Item No.	LUX-KINDLE-ECO
Input Power	6W
Lumen Output	540LM
Dimension	D86mmxH49mm
Hole Cutout Size	55mm
Install	Recessed
Dimming Options	Triac Dimming
Colour Finish	White
Connection Type	Junction Box with Terminals
Warranty	3 Years
IP Rating	IP65 (Front)
IK Rating	N/A
IC Rating	N/A
Approvals	CE/UKCA
Emergency Option	N/A
Microwave Sensor Option	N/A

Photometric

Efficacy	90lm/W
Light Source	LED SMD
CCT	3000 / 4000 / 6000K
CRI	>80
Beam Angle	60°

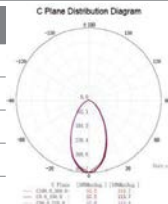

Electrical

Driver	Built-In
Voltage Rating	220-240V
Operating Frequency Hz	50/60Hz
Class	II
Power Factor	>0.85
Input Electrical Connections	Junction Box
Useful Life @T125° Useful Life	30,000 hours
Operating Ambient Temp.	-20° to 25° (for IC)

Package

Inner Box Size - cm	(LxWxH) 8.8x5.5x10.5
Outer Carton Size - cm	(LxWxH) 37.5x30x23.2
Quantity Per Outer Carton - pc	40
Outer Carton Net Weight - kg	6.5
Outer Carton Gross Weight - kg	8.0
20GP Quantity - pc	43080
40FT Quantity - pc	89240

EMERGENCY
LIGHTING



EXIT



BULKHEAD

LED emergency bulkhead with up, down, left, right direction legends pack. Constructed from polycarbonate.

- Suitable for surface mounting
- 5.0W maintained at 2.5W non-maintained functions
- 3 hour emergency running time
- 24 hour charge time
- IP65 rated for indoor and outdoor use
- Features an integrated emergency driver fitted with a 3.6V 1.5Ah Ni-cd battery



Code	Lumens (lv)	Volts (V)	Dimensions			Order Quantity
			W	D	H	
Single Carton						
LUX-3H/MNM-BH	150	220-240	352	68	110	1

Dimensions & Available Lengths

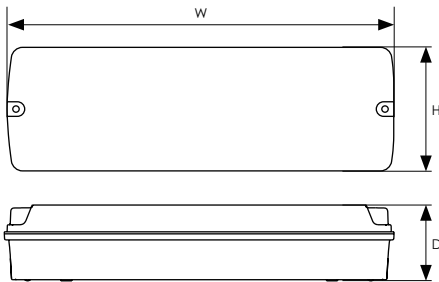

Project Information

Product Name	Exit Sign
Catalogue Number	LED Emergency Light
Notes	Manual Test

Specifications

Features & Specifications

- LiFePO4 Lithium battery provides improved energy consumption, product reliability and lifetime.
- Supplied with all legend options - arrow down, arrow up and arrow left/right.
- Test switch function available.

Construction

Material	Polycarbonate
Internal / External	Internal

Electrical

Emergency Power	1W
Viewing Distance	30M
CRI	≥80
CCT	6500K
Power Factor	≥0.35
Battery Type	LiFePO4 3.2V 1.5Ah
Class Protection	1
Manual Testing	Test Switch
IP Rating	IP20
Lamp Type	Manual Test

Temperatures

Operating Temp	0°C to 45°C
----------------	-------------

Installation

Mounting	Wall Mount
----------	------------

Warranty

Warranty (Years)	3 Years
------------------	---------



Easy open switches at laterals

Dimensions

Unit: mm

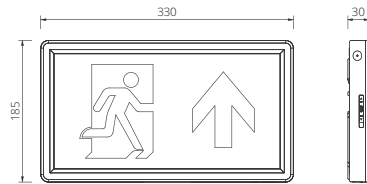

Installation

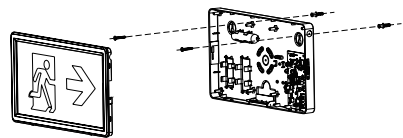

Other Information

Item No.	Input Voltage	Hertz	Input Watts	Lumens	Charge Time	Emergency Time
LUX-EB-3HEM	220-240V	50/60Hz	3.5W MAX	N/A	24h	>3H

Packaging Information

Item No.	Product Size (LxWxHmm)	Inner Box Size (LxWxHmm)	Qty / Carton	Carton Size (LxWxHmm)	N/W / Carton KG	G.W / Carton KG
LUX-EB-3HEM	300x185x35	336x192x40	12	495x350x210	7.58	8.13

3W EMERGENCY PIN SPOT

Standard and Self Test

Electrical & Output Data

Model No.	LUX-EMDL-3W
Rated Voltage	220-240V-50/60Hz
Operating Mode	Non-maintained
Rated Wattage	3W
LED	3535
Correlated Colour Temperature	6000K
Emergency Luminance Flux	≥ 150lm
Battery	LiFePo4 3.2V / 1500mAh
Charge	24H
Discharge Duration	3H
Battery Life	Up to 4 years
Power Factor	≥ 0.4
Operating Temp Range	0~40°C
Weight	0.23KG
Warranty	2 years
Remark	Electric shock protection class: IP20 Powercord: H03VV-F-2x0.75mm2



IP65 EMERGENCYTWIN SPOT

These emergency twin spots are ICEL endorsed and manufactured to provide full compliance to current standards, including BS60598-2-22

With an optional self-test feature, LUX-FXTS02 punches above its weight in terms of both value and functionality.



BESPOKE LED STRIP CUTTING SERVICE



BESPOKE LED STRIP
CUT TO LENGTH
SOLDERED
HEAT SHRUNK
INDIVIDUALLY BAGGED

..... SAVING YOU TIME & ENERGY!



Units 17-18 Matrix Way
Buckshaw Village
PR7 7NA

www.luxliteuk.com
sales@Luxliteuk.com

Tel: +44 (0)1253 890 211