



Caution, risk of fire



EH5934

Prem-I-Air 12,000 BTU Portable Local Air Conditioner
With Remote and App Control, Near Universal Window
Fixing Kit, Dust Cover and Insulated Sleeve for Exhaust
Hose



User Manual

Please Retain for Future Reference

IMPORTANT

Installer and Users please note:

These instructions should be read carefully and left with the user of the product for future reference.

BEFORE USE

- Inspect the product (including its cable and plug) for any signs of damage; If the product is damaged in anyway do not use it and contact your supplier immediately.
- The product contains a refrigerant gas, so it must be kept upright at all times.
- After unpacking wait 3 hours for the refrigerant gas to stabilise before use.
- Insert 2 x 1.5V AAA batteries (not supplied) into the battery compartment of the remote control.

PRODUCT SAFETY

- **WARNING!** Appliance shall be installed, operated and stored in a room with a floor area larger than 8m²
- This appliance can be used by children aged from 8 years and above and persons with reduced physical, sensory or mental capabilities or lack of experience and knowledge if they have been given supervision or instruction concerning use of the appliance in a safe way and understand the hazards involved
- Children shall not play with the appliance
- Cleaning and user maintenance shall not be made by children without supervision.
- For indoor use only
- Do not use in bathrooms, wet rooms or other damp locations
- Do not use this product with an extension lead
- Use of this product in boats, caravans, mobile homes or other similar locations is forbidden
- There must be a minimum 300mm safe area around the sides and 1200mm above the product that is clear of obstructions and flammable materials
- Do not place the mains lead beneath a carpet or rug
- Do not use this appliance in locations where paint, petrol or other flammable liquids are used or stored
- Please ensure the appliance is switched off and unplug when not in use.
- Do not use the appliance for other than its intended use.
- Do not insert any object into the appliance through the grilles. This may damage the product or result in overheating or electric shock.
- Only use this product on a flat, stable surface.
- Do not leave this product unattended when in use.
- For domestic use only.
- There are no user serviceable parts in this product.
- Allow to cool down before moving.
- Do not use under curtains or close to soft furnishings.
- Do not leave water in this product for prolonged periods of time
- Do not move or knock this product while in use. Risk of Electrical Shock
- Disconnect the product from the mains before emptying the unit
- This appliance is fitted with an overload cut-out which will operate if the motor overheats or is stalled. If this happens, disconnect from the mains supply immediately and allow the motor to cool down
- Do not use if incorrectly fitted
- Do not obstruct the air intakes and exhaust vents on this appliance.
- Do not cover.
- This product must only be used and transported in an upright position.
- Do not use in areas with high concentrations of dust or fibre particles.
- This unit must be switched off and disconnected from the mains before the tank is emptied or filters cleaned.
- The refrigerant loop is sealed. Only a qualified technician should attempt to service
- No open flames, cigarettes or other possible sources of ignition should be used inside or in the vicinity of the units.

SYMBOLS FROM THE UNIT AND USER MANUAL



This unit uses a flammable refrigerant. If refrigerant leaks and comes in contact with fire or heating part, there is risk of fire.

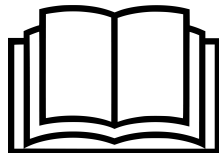

Read the **USER MANUAL** carefully before operation.



Further information is available in the **USER MANUAL**, **SERVICE MANUAL**, and the like.

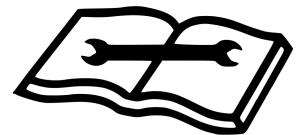

Service personnel are required to carefully read the **USER MANUAL** and **SERVICE MANUAL** before operation.

PRODUCT DIAGRAM

- 1. Control Panel
- 2. Air outlet with adjustable Louvre
- 3. Air Inlet with Air Filter
- 4. Power Cord
- 5. Recessed Handle
- 6. Air Exhaust
- 7. Drain opening with Sealing Plug

Note: the appearance is only for reference, please see the real product for detailed information.

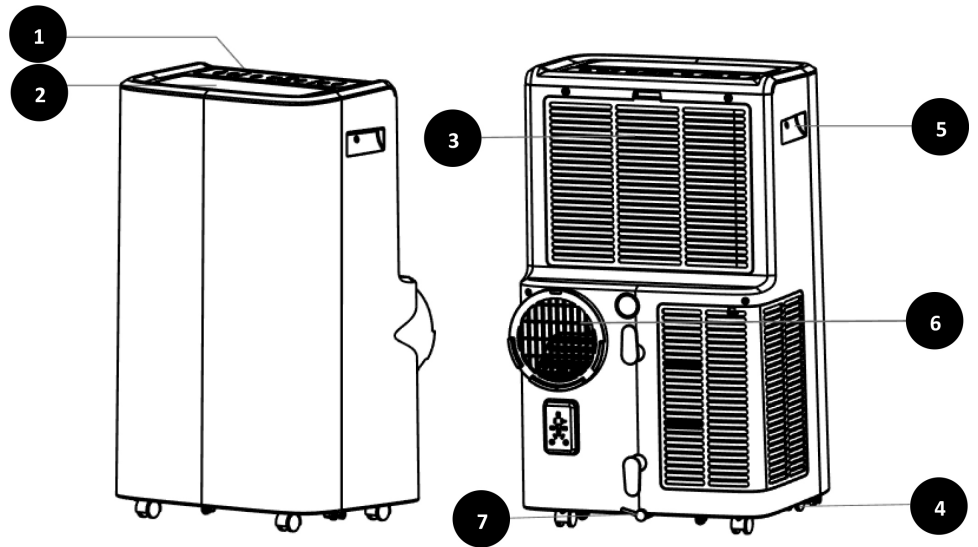

ACCESSORIES

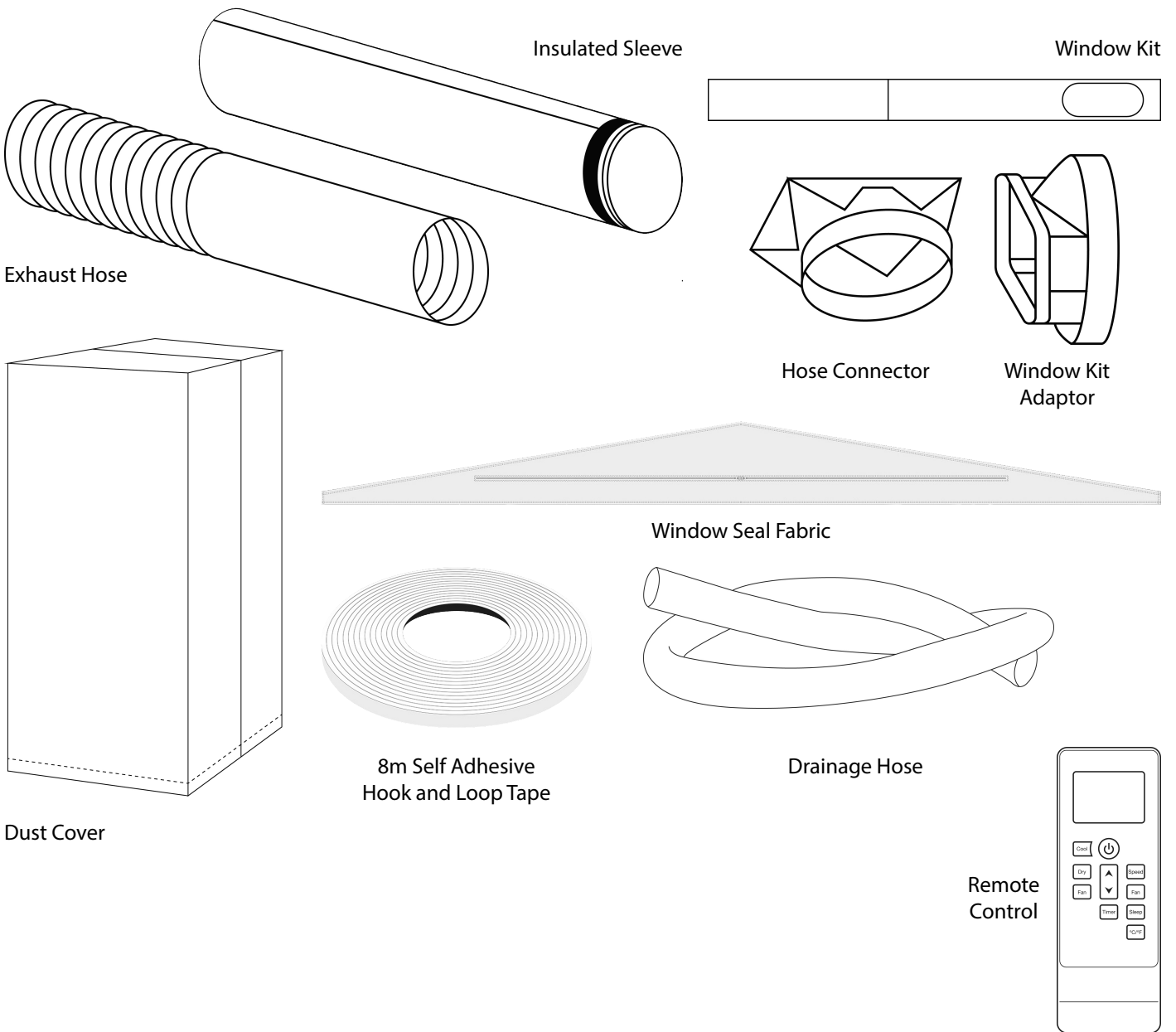

FITTING THE WINDOW KIT (SLIDING WINDOWS)

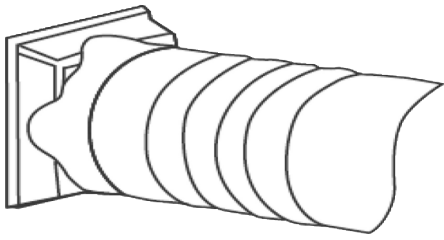

1. Connect the hose connector to one end of the exhaust hose

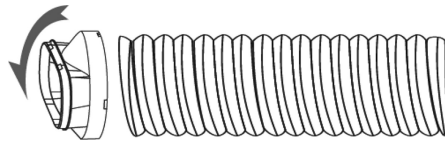

2. Connect the windows adaptor kit to the other end of the exhaust hose

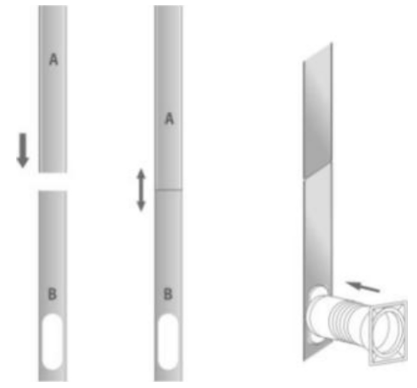

3. Extend the adjustable window kit the length of the window

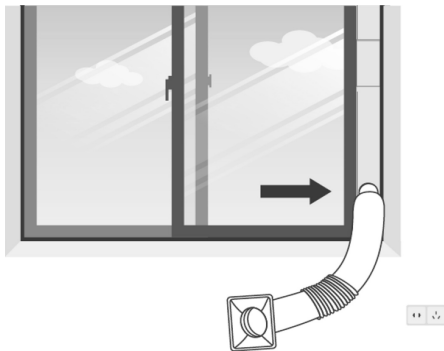

4. Close your window to secure the kit in place. It needs to hold the window kit firmly in place.

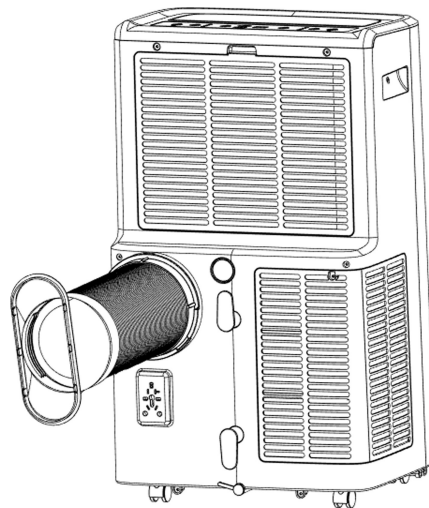

5. Attach the hose connector to the exhaust air outlet of the unit.

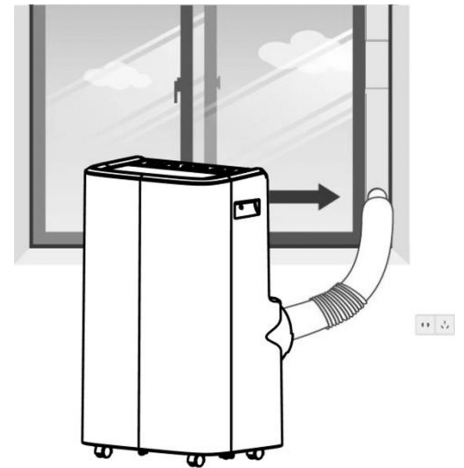

6. Adjusting the length of the flexible exhaust hose, and avoiding bends in the hose, then place the AC in the desired location.

FITTING THE WINDOW SEAL KIT (CASEMENT WINDOWS)



Window Seal Fabric

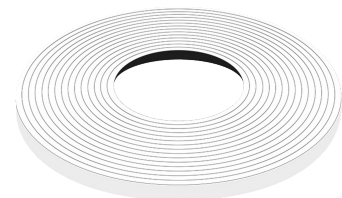

8m Self Adhesive Hook and Loop Tape

BEFORE USE

Check your kit contains the following items.

- 1 x 8m reel of hook and loop tape
- 1 x 4m material seal fitted with hook and loop tape

IMPORTANT SAFETY INFORMATION AND ADVICE

- 1) This kit is designed to work with casement windows only with a perimeter of up to 4m.
- 2) Do not use this product in strong or gusty winds. Windows should be secured and locked in place.
- 3) Do not allow children and pets to play in the vicinity of this product. Fall risk.
- 4) Windows are not secure when using this product. Close windows and lock in place when not in the room Security/fall risk.

FITTING THE WINDOW SEAL KIT (CASEMENT WINDOWS)

INSTALLING THE PRODUCT

The product is fitted with hook and loop tape that allows the product to be quickly installed and removed from the window. Follow these simple instructions below to understand how to install this product.

- 1) Measure both the dimensions of your window frame and the casement window as per the diagram.
- 2) Using these measurements cut the hook and loop tape into 8 sections matching the measurements you have taken from the window and window frame. 2 x size A, 2 x size B, 2 x size C, 2 x size D.
- 3) In turn remove the backing from the tape and fix the strips to the corresponding place on the window as indicated in the diagram
- 4) Lay the material section flat onto a tabletop.
- 5) Find the middle point of the straight side of the material and fix this on to the tape attached to the casement window close to the handle of the window by pressing the hook and loop tapes together. Work out from this point on both sides fixing the material in place.
- 6) Find the mid-point of the material section on the curved side and begin to fix this to the tape on the window frame starting at a point close to the handle. Work out on both sides fixing the material in place as you go.
- 7) Any spare material should be rolled up and tied in place.
- 8) Slowly open the window until the material is taught between the frame and the window.
- 9) The material section is fitted with two zips which can be adjusted to produce a suitable aperture for the exhaust hose of your air conditioned to fit through. After adjusting these zips feed the exhaust hose through the aperture making sure that the exhaust hose is at least 5 inches through this gap. Close the zips to clamp the hose in place. If the zips are moving out of position fix a cable tie (not supplied) through each of the zip puller tags and tighten until the hose is fixed in place.
- 10) The material section can be removed and reinstalled onto the hook and loop as required.

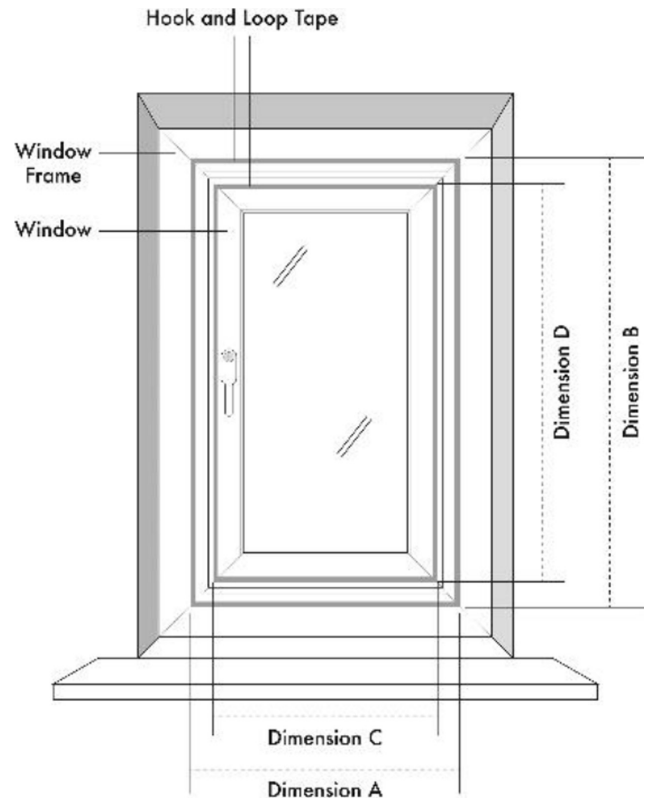

ATTACHING INSULATED SLEEVE TO EXHAUST HOSE

An insulated sleeve is included, to reduce parasitic heat entering the room through the exhaust hose.

The insulated sleeve has a length of hook and loop along each side.

To attach the sleeve to the exhaust hose, simply wrap the sleeve around the hose, bringing the 2 sides together and joining the hook and loop.

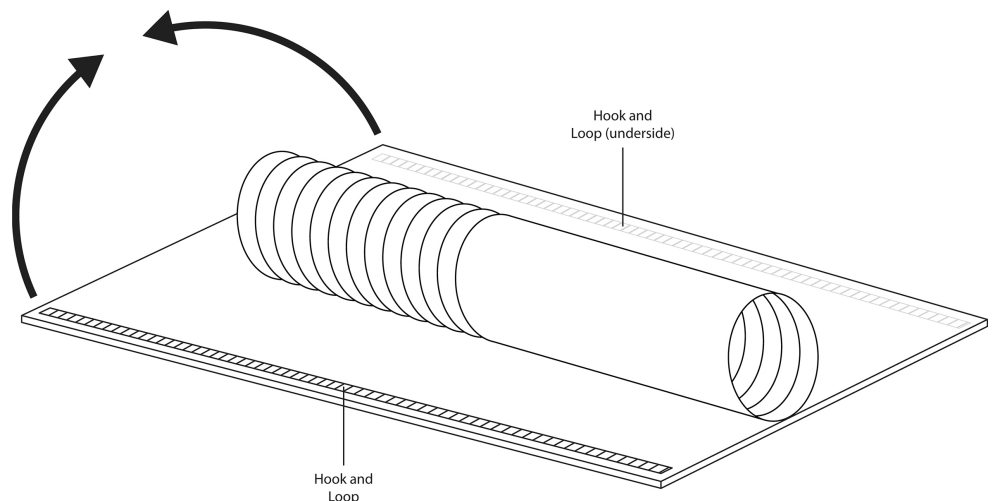

CONTROL PANEL AND DISPLAY

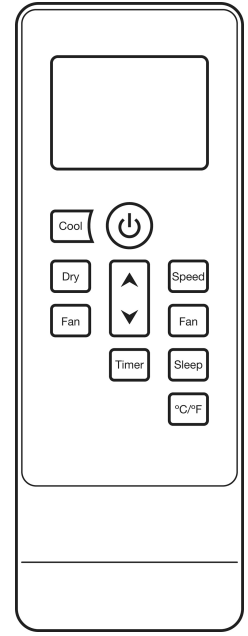
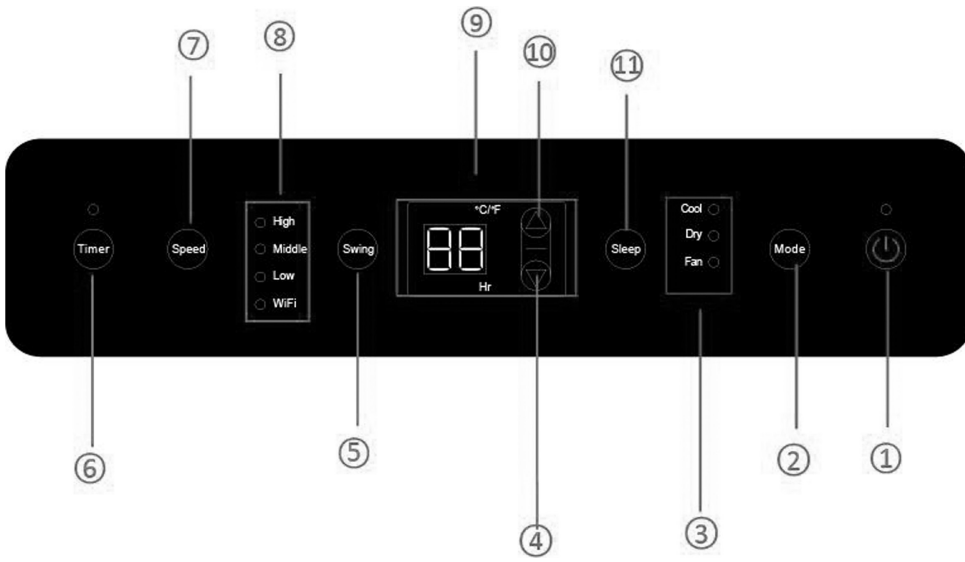

1	Power	Press to switch the machine on or off.
2	Mode	Mode button. Press to switch the operation mode between cool, fan and dry.
3	Indicators	LED for 3 operation modes. Select by pressing mode button.
4	Minus	Decreasing the desired temperature or timer setting.
5	Swing	Adjust the horizontal air flow direction
6	Timer	Sets a time for the unit to automatically start or stop.
7	Fan Speed	Press to switch the fan speed between High, Low and Medium
8	Indicators	LED for fan speed (High/Medium/Low)
9	Digital Display	Displays timer setting and room temperature.
10	Add	Increasing the desired temperature (16°C~32°C) or timer setting.
11	Sleep	Press to turn sleep mode on or off.

OPERATION

The unit has 4 operating modes: Cool, Fan, Dry, Sleep

1. START UP AND SHUTDOWN

- 1.1. Press POWER to turn the unit on (the unit runs in FAN mode as default)
- 1.2. Press MODE button to select the desired operating mode
- 1.3. Press POWER again to turn off Caution!: The unit must only be shut down using the control panel or remote control, never directly unplug the unit from the mains as this can seriously damage the unit and increase the risk of fire

2. COOLING MODE

- 2.1. Press MODE button until the COOL LED is illuminated
- 2.2. Use ADD and MINUS buttons to adjust the temperature which is displayed on the screen. The temperature can be set between 16°C and 32°C
- 2.3. Press SPEED button to adjust the fan speed
- 2.4. To control the direction of the air flow, please adjust the inner louver by hand. Note: The air conditioner stops if the room temperature is equal to the selected temperature

3. VENTILATING YOUR ROOM

- 3.1. Press MODE button until the FAN LED is illuminated
- 3.2. Press SPEED button to adjust the fan speed Note: in ventilation mode the room air is circulated, but not cooled

4. DRYING YOUR ROOM

- 4.1. Press MODE button until the DRY LED is illuminated
- 4.2. In this mode the fan speed cannot be adjusted
- 4.3. It is recommended that the user connects the hose to the drain outlet on the bottom of the unit

OPERATION (CONTINUED)

5. SLEEP MODE

This is only available during cooling mode and can only be activated using the remote control.

- 5.1. Press the sleep button on the remote control – after one hour the preset temperature is increased by 1°C. this increases after another hour until the current room temperature is achieved.

SETTING THE TIMER

The timer can be used for 2 operations: Delay start and Delay stop

1. DELAY START

- 1.1. When the unit is turned off, press the TIMER key to turn on timer function
- 1.2. Use the ADD and MINUS buttons to set the timer value
- 1.3. The unit will switch on after the set number of hours

2. DELAY STOP

- 2.1. When the unit is switched on, press the TIMER key to turn on the timer function
- 2.2. Use the ADD and MINUS buttons to set the timer value
- 2.3. The unit will switch off after the set number of hours
3. To cancel the timer, use the ADD and MINUS buttons to set the timer value to "00"

AUTOMATIC DEFROST

At low room temperatures, frost may build up at the evaporator during operation. The unit will automatically start defrosting and the POWER LED will blink. The defrost control sequence is as follows: When the unit is operating in cooling or drying mode, and the evaporator coil temperature is below -1°C, the compressor will stop operating for 10 minutes until the coil temperature is up to 7°C – the unit will then restart to cool operating mode.

APP CONTROL

The "Smart Life" app is available for android and iOS.

Scan the QR code to download



This appliance allows you to operate the appliance via your home net-work.
A permanent WIFI connection to your router and the free app "Smart Life" are needed.

When the app is downloaded and installed;

1. Create a user account.
2. Place the appliance at a distance of about 5 meters to your router.
3. Long press the "Timer" button to start the network configuration, when the WIFI indicator flashes, you can connect the WIFI.
After 3 minutes, the status will be cancelled if there is no network configuration, and the indicator light is off. If you need to re-connect the WIFI, long press the "Timer" button to start the network configuration again, the WIFI indicator will flash again.

You can connect to the appliance via bluetooth or WIFI;

CONNECTING VIA BLUETOOTH

1. Open the bluetooth settings on your mobile phone or other device.
2. When the WIFI indicator flashes on the appliance, open the "Smart Life" APP, the unit will connect via bluetooth automatically.

CONNECTING VIA WIFI

1. When WIFI indicator flashes, select "Add Device"- "Small Home Appliances"- "Dehumidifier", and follow the instructions on the display.
2. Check the status of the WIFI indicator;
 - If the WIFI indicator flashes rapidly, it can connect.
 - If the WIFI indicator flashese slowly, press "Go to Connect" to connect the WIFI named "SmartLife-XXXX", then go back to the APP and the WIFI will connect.

Once the appliance has been successfully connected, the WIFI light will come on. Now you can operate the appliance using the app.

Press and hold the "Timer" button for about 5 seconds, the appliance will disconnect and the WIFI light will go off.

OVERLOAD PROTECTION

In the event of a power loss, to protect the compressor, there is a 3-minute delay until the compressor restarts.

DRAINAGE

The self-evaporating system uses the collected water to cool the condenser coils for more efficient performance. There is no need to empty the drainage tank in cooling mode except in exceptionally high humidity conditions. The condensate water evaporates at the condenser and is evacuated through the exhaust hose.

For continuous operation in drying mode, please connect the included drain hose to the unit. Condensate water can then be directly drained into a bucket or similar.



- Switch off the unit before draining
 - Remove the plug of the water outlet opening and keep it in a safe place
 - Securely and properly connect the drain hose and ensure it is not kinked and is clear of obstruction
 - Place the outlet of hose over a drain or a bucket and ensure that water can flow freely out of the unit
 - Do not submerge the end of the hose into water, as this can cause an "air lock" in the hose
 - To avoid water spillage, tilt the drain hose down towards the floor and straighten out any kinks in the hose
- Note: Remember to replace the plug after using the drain hose!**

CLEANING THE AIR FILTER

Dust collects on the air filter and restricts the airflow. The restricted airflow reduces the efficiency of the system and if it becomes blocked it can cause damage to the unit.

The air filter requires regular cleaning. The air filter is removable for easy cleaning. **DO NOT OPERATE** the unit without the air filter or the evaporator may become contaminated.

1. Press POWER button to switch off the unit, then unplug the unit from the mains
2. Remove the filter mesh from the back of the unit
3. Use a vacuum cleaner to suck dust from the filter
4. Turn the filter over and rinse the air filter under running water. Let the water run through the filter in the opposite direction of air flow. Set aside and allow the filter to air dry before reinstalling.

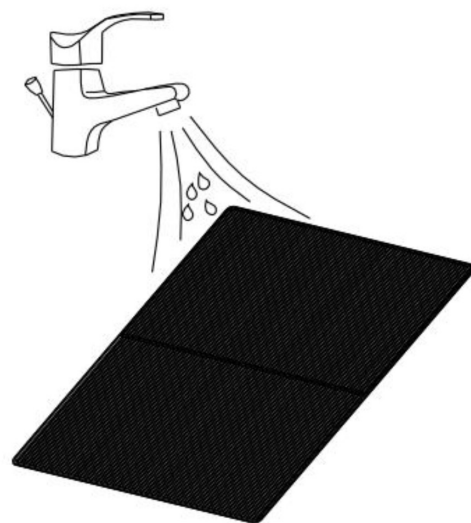

WARNING! To prevent accidental injury from extreme temperatures and sharp edges, do not touch the evaporator surface!

STORAGE

For long term storage (more than a few weeks) it is best to clean the unit and dry it out completely:

1. Unplug the unit and remove exhaust hose and window kit.
2. Drain the remaining water from the unit
3. Clean the filter and let the filter dry completely
4. Collect the power cord at the water tank
5. Re-install the filter in its position
6. The unit must be kept in upright position when in storage
7. To preserve the unit, keep in a dry, well ventilated space indoors.

Note: The evaporator has to be completely dried out to avoid component damage and mould. Unplug the unit and leave in a dry open area for a few days to completely dry it out.

TROUBLESHOOTING

Symptom	Inspection	Solution	
The unit is not operating.	Check the power connection is connected securely.	Insert the power cord securely into the wall outlet.	
	Check if the water level indicator lights up?	Empty the drain pan by removing the rubber plug.	
	Check the room temperature.	The range of operating temperature is 5°C~35°C	
The unit works with reduced capacity.	Check the air filter for dirt.	Clean the air filter if necessary.	
	Check if the air duct is blocked.	Clear any obstruction.	
	Check if the room door or window is open.	Keep the doors and windows closed.	
	Check if the desired operating mode is selected and the temperature is properly set.	Set the mode and temperature at proper set point according the manual.	
	The exhaust hose is detached.	Make sure the exhaust hose is securely attached.	
Water Leakage	Overflowing while moving the unit.	Empty the water tank before transport.	
	Check if the drain hose is kinked or bent.	Straighten the hose to avoid kinking.	
Excessive Noise	Check if the unit is securely positioned.	Place the unit on horizontal and firm ground.	
	Check for any loose, vibrating parts.	Secure and tighten the parts.	
	Noise sounds like water flowing.	Noise comes from flowing refrigerant. This is normal.	
Error Codes	E0	Communication faults between main PCB and display PCB.	Check the wire harness of the display PCB for damage.
	E1	Ambient temperature sensor failure	Check connection or replace it. To clean or replace the temperature sensor.
	E2	Coil temperature sensor failures.	Check connection or replace it. To clean or replace the temperature sensor.
	Ft	Condensate water high level alarm.	Empty the drain pan by removing the rubber plug.

GENERAL SAFETY REQUIREMENTS

Domestic wiring must be tested periodically by a qualified electrician at least once every 10 years or at every change of occupancy. For office and retail premises, and buildings such as village halls, the wiring must be inspected at least once every 5 years. It is recommended that all building be fitted with smoke alarms (it is mandatory for new buildings).

TESTING

When used in an office environment, we recommend that this product should be safety-tested yearly by a qualified electrician (PAT Tested).

We recommend that it is PAT tested regularly when used in a domestic environment.

If the mains lead is damaged, it must be replaced by the manufacturer or an authorised service centre. If the mains plug needs to be replaced, proceed as follows:

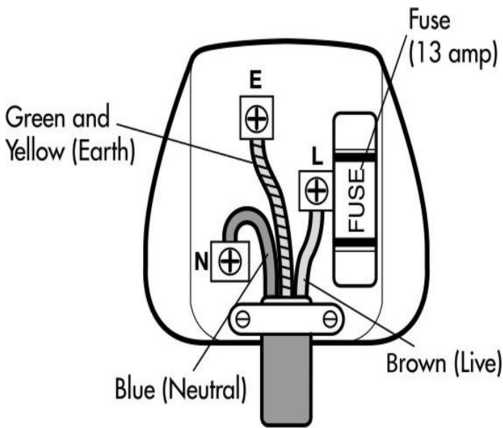

- Connect the brown wire to the terminal labelled “L”
- Connect the blue wire to the terminal labelled “N”
- Connect the green and yellow wire to the upper terminal labelled “E”
- Make sure that the cord-grip is positioned correctly (over the outer sheath of the cable) and it fully tightened.
- If the plug is fitted with a fuse other than 13A, then please replace with an approved fuse of the correct value.

OPERATING COSTS

At time of going to press, the average cost of electricity is £0.25 per unit (kilowatt-hour). The amount you are being charged will be shown on your electricity bill. At this cost, the EH5934 will cost £8.00 per day to run on the “High Speed” setting.

DISPOSAL AND RECYCLING

You must not dispose of this appliance with domestic household waste.

Most local authorities have specific collection system for appliances and disposal is free of charge to the end-user. When replacing an existing appliance with a similar new appliance your retailer may take the old appliance for disposal.

TECHNICAL SPECIFICATION

Product Code	EH5934
Cooling Capacity (Btu/h)	12,000
Power Supply	230V~
Rated Cooling Input (W)	1337W
Rated Current Cooling (A)	5.9
EER For Cooling (W/W)	2.63
Noise Level (dB) (High)	65
Product Dimensions (mm)	722 x 360 x 420
Packaging Dimensions (mm)	880 x 510 x 460
Refrigerant (Type/Charge)	R290/240g
Net Weight (kg)	29
Gross Weight (kg)	33
Application Area (m2)	18-25
Fan Speeds	3
Louvres	Automatic
Louvres	Manual

WARRANTY

Prem-i-Air guarantees the product free from defects in materials and workmanship for a period of twelve months. Should this appliance be operated under conditions other than those recommended, at voltages other than the voltage indicated on the appliance, or any attempts made to service or modify the appliance, then the warranty will be rendered void. The product you buy may sometimes differ slightly from illustrations. This warranty is in addition to, and does not affect, your statutory rights. Our guarantee is administered by our retailers.

If your product arrives damaged, you must contact the retailer from whom you bought it. The retailer's contact details will be on the invoice that arrived with the product, or on the e-mail you received when you placed the order. Do not contact Prem-i-air, only your retailer can arrange a replacement. If your product fails within the guarantee period, firstly read the "fault finding" section of this manual, because temperature and weather conditions can affect the performance of certain products.

If the product needs to be repaired or replaced, you must contact the retailer from whom you bought it. The retailer's contact details will be on the invoice that arrived with the product, or on the e-mail you received when you placed the order. If you have just received your product and require technical help in using it, please call our Help Desk on (0845) 459 4816. If you have any other technical queries about the product, please call our Help Desk on (0845) 459 4816.

Manufacturer/Importer

Name: Prem-i-Air Appliances Ltd.
Address: Lancots Lane, Sutton Oak, St. Helens, WA9 3EX
Tel: 01744 745 030
E-mail: sales@prem-i-air.co.uk

EU Authorised Representative

Name: Aidapt B.V.
Address: Algolweg 22,
Amersfoort, 3821BH, NL
Tel: +31 0332779210
E-mail: nederland@aidapt.eu



PSTI COMPLIANCE STATEMENT

Product Security Statement of Compliance (in accordance with the UK Product Security and Telecommunications Infrastructure (Security Requirements for Relevant Connectable Products) Regulations 2023)

Manufacturer: Prem-i-air Appliances Ltd, Lancots Lane, Sutton, St. Helens, Merseyside WA9 3EX | Email: sales@prem-i-air.co.uk

Product Identification:

- **Product Name:** Prem-I-Air 12,000 BTU Portable Local Air Conditioner
- **Model Number(s):** EH5934
- **First Date Supplied:** 01/01/2026
- **Batch/Serial Number:** See product label or packaging
- **Product Description:** Wi-Fi enabled Air Conditioner, controllable via mobile application

Statement of Compliance: This product complies with the security requirements set out in Part 1 of the Product Security and Telecommunications Infrastructure (Security Requirements for Relevant Connectable Products) Regulations 2023.
Security Update and Support Period: Security updates and vulnerability management support will be provided for a minimum of 3 years from the date the product is first supplied in the United Kingdom.

Password Policy: No universal default passwords are used.

Vulnerability Disclosure Information: In accordance with paragraph 2(3) of Schedule 1 of the Regulations and ISO/IEC 29147, the manufacturer provides a public mechanism for receiving and managing reports of security vulnerabilities.

- **Reporting mechanism:** Vulnerabilities can be reported by email to sales@prem-i-air.co.uk.
- **Acknowledgement:** The manufacturer will acknowledge receipt of a vulnerability report within 5 working days.
- **Ongoing communication:** The manufacturer will maintain communication with the reporter and provide progress updates at least every 30 days until resolution or closure of the report.

Signature:

Authorised Signatory: Chris Hale

Position: Digital Compliance Manager

Company: Electrovision Ltd

Date of Issue: 01/01/2026

Defined Support Period: Until 01/01/2031