

SMART WIFI PUSH BUTTON SWITCH



More Control on your Light Switch
Also works with our Eco Range of
Kinetic Switches & Receivers

No neutral required



Wi-Fi
Controlled



No Hub
Required



Device
Sharing



Timing
Function



Scheduling



Voice
Control



Smart WiFi Push Button Switch

Mechanical Switch, APP & Voice Control.

Also can be used 2 way with our ECO Series Wireless Kinetic Switches

SKU: SHA5351 - SHA5352 - SHA5353

Features:

- Big Push Button with LED Indicator showing lights are on or off.
- No neutral wire is required, only need live wire (small capacitor needs to be used in the wiring)
- App Control: No hub required. Using our Free to Use ENERJSMART App, you can control the lights no matter where you are. Create scenes to control a group of light switches. Share the control with family members.
- Voice Control: Compatible with Amazon Alexa (Echo & Echo Dot), Google Assistant, Siri and Apple Watch (please check manual for more details), control your lights with the smart light switch by simply giving voice commands.
- Reduce your power usage with the Timer Setting Feature on the APP. You can set exact times for the light switch to turn on or off, thereby helping you reduce your energy bills.
- Can be Used 2 Way with our ECO Series Wireless Kinetic Switches. You will not be needing an additional receiver module.

More Control on your Light Switch
Also works with our Eco Range of
Kinetic Switches & Receivers



Technical Specifications:

| | |
|-------------------------------|---------------------------------|
| Model No: | EM301W/EM302W/EM303W |
| Gang: | 1/2/3 Gang |
| Colour: | White |
| Operating voltage: | AC 100-250V 50Hz/60Hz |
| Rated load: | Each gang 200W |
| Self-consuming power: | Less than 1mA |
| Operating environment: | -20°C~50°C, less than 95%RH |
| Wireless frequency: | Wi-Fi 2.4GHz (5G not supported) |
| RF frequency | ASK/433.92MHz |
| Life: | More than 100,000 clicks |
| Dimension | 86*86*40mm |
| Weight: | 155g |

More Control on your Light Switch
Also works with our Eco Range of
Kinetic Switches & Receivers



SKU: SHA5351 - SHA5352 - SHA5353

Wiring Diagram

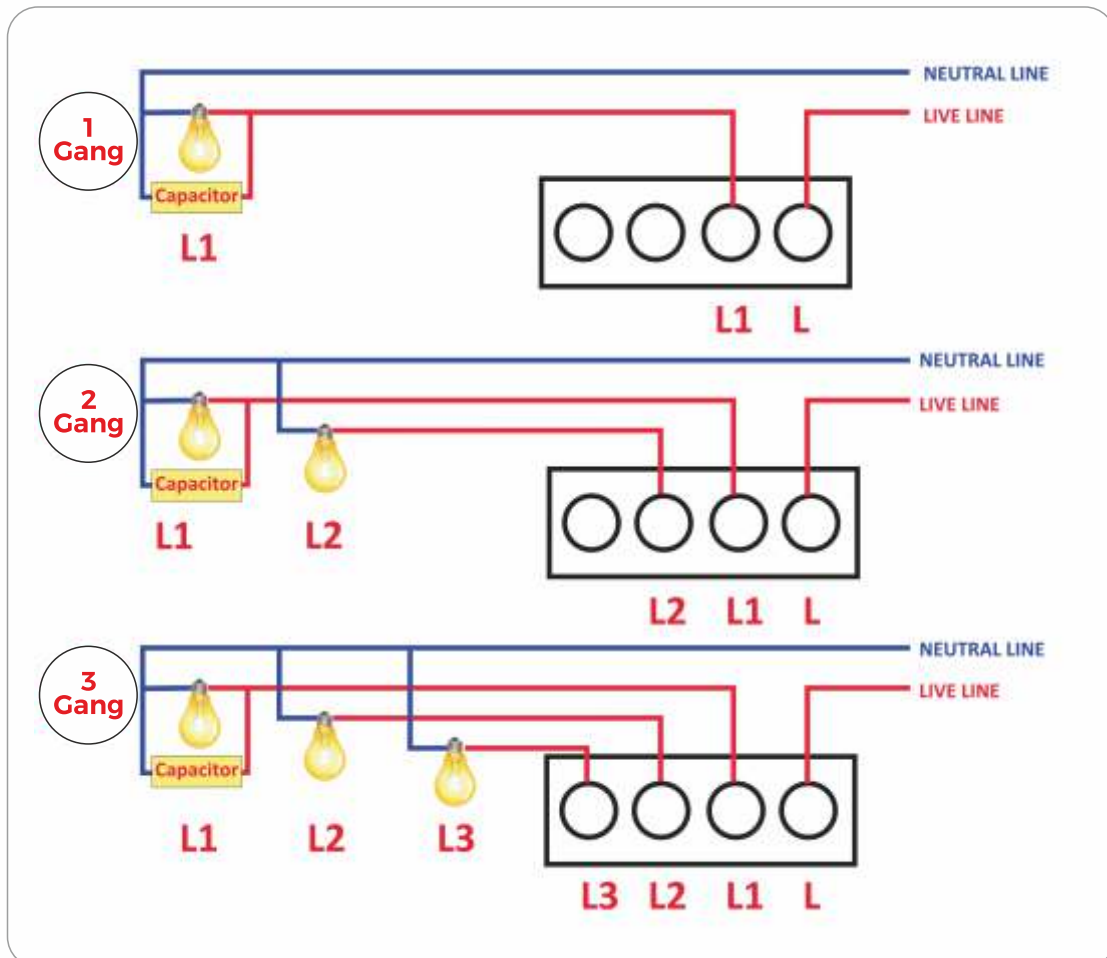

More Control on your Light Switch
Also works with our Eco Range of
Kinetic Switches & Receivers



SKU: SHA5351

How to Use it as a 2 Way with our ECO Range Kinetic Switches (SKU WS1050X/WS1051X/WS1052X series)

1

SHA5351
1 gang smart wired switch

WS1050X
1 gang wireless kinetic switch



pair with kinetic switch



Step1: Connect Smart Switch to power supply
Step2: Hold "pairing key" for 3 seconds.
Step3: Release it when red light is on
Step4: Press S3 switches once
Step5: Finish pairing



Note: The 2-Gang and 3-Gang should need to be paired separately for each RF circuit. When receiver goes into pairing mode and if no switch is paired then the receiver will exit pairing mode after 60S and the red indicator goes off

More Control on your Light Switch
Also works with our Eco Range of
Kinetic Switches & Receivers



SKU: SHA5352

How to Use it as a 2 Way with our ECO Range Kinetic Switches (SKU WS1050X/WS1051X/WS1052X series)

2

SHA5352
2 gang smart wired switch

WS1051X
2 gang wireless kinetic switch

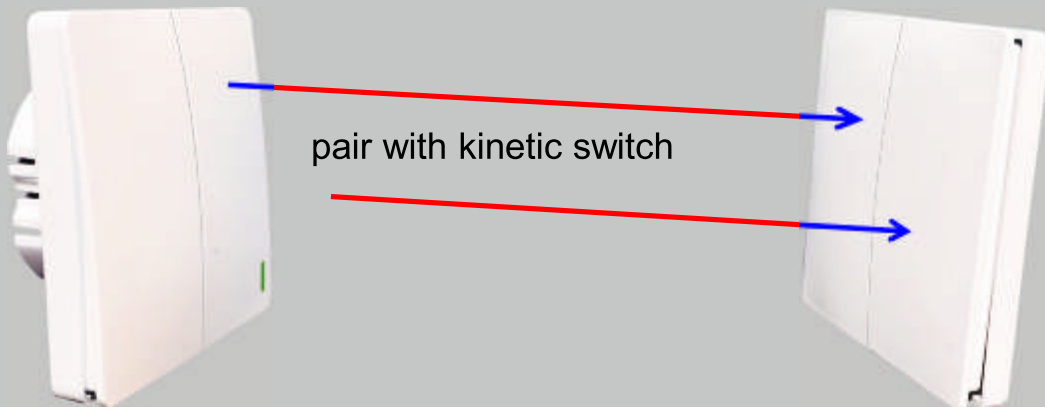



pairing key indicator

Step1: Connect Smart Switch to power supply
Step2: Hold "pairing key" for 3 seconds
Step3: Release it when red light is on
Step4: Press S3 switches once
Step5: Finish pairing



Note: The 2-Gang and 3-Gang should need to be paired separately for each RF circuit. When receiver goes into pairing mode and if no switch is paired then the receiver will exit pairing mode after 60s and the red indicator goes off

More Control on your Light Switch
Also works with our Eco Range of
Kinetic Switches & Receivers



SKU: SHA5353

How to Use it as a 2 Way with our ECO Range Kinetic Switches (SKU WS1050X/WS1051X/WS1052X series)

3

SHA5353
3 gang smart wired switch

WS1052X
3 gang wireless kinetic switch

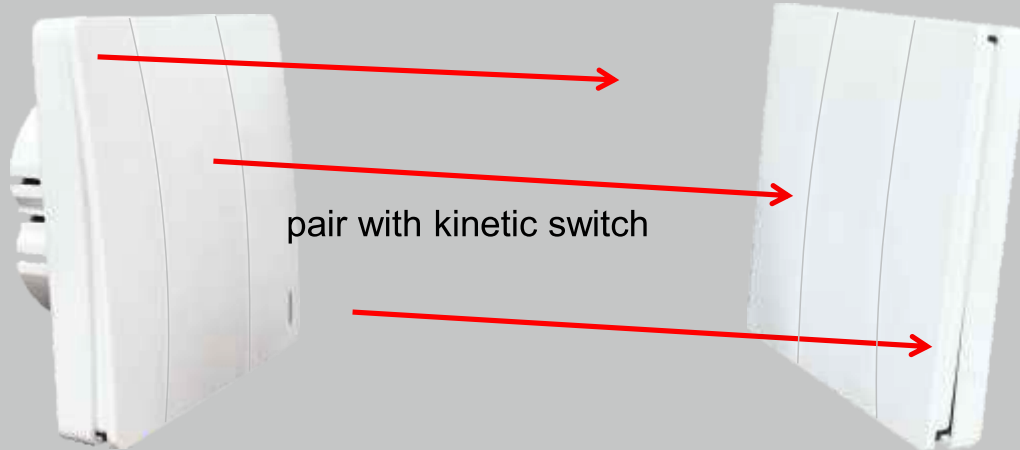

pairing key: 

indicator 

Step1: Connect Smart Switch to power supply
Step2: Hold "pairing key" for 3 seconds
Step3: Release it when red light is on
Step4: Press S3 switches once
Step5: Finish pairing



Note: The 2-Gang and 3-Gang should need to be paired separately for each RF circuit. When receiver goes into pairing mode and if no switch is paired then the receiver will exit pairing mode after 60S and the red indicator goes off

More Control on your Light Switch

Also works with our Eco Range of
Kinetic Switches & Receivers



SKU: SHA5351 - SHA5352 - SHA5353

.....

Thank you for choosing ENER-J!

Customer satisfaction is our TOP priority, please let us know how you felt about your experience. Happy?

We are so happy that you are pleased with our product. Feel free to express your newfound joy! Share your experience by writing a review.

Not Happy? If you are not fully satisfied with the item you received, have any problems like damages, or questions, please contact us. We typically respond within 24-48 hours.

Stuck? Confused?

Contact our Technical Support team on:

T: +44 (0)1291 446 105 E: support@ener-j.co.uk

Lines are open Mon - Fri (8am to 4pm)