

GLP20+RDE black

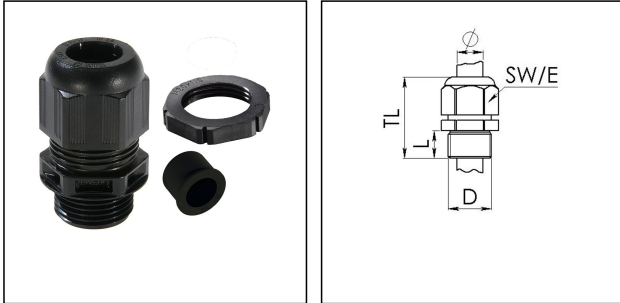

Products may differ in size, colour and appearance to those shown. If you require further information or customisation, please contact us directly.



Material cable gland	Polyamide
Material sealing gasket	EPDM
Protection class	IP69, IP68 (5 bar 30 min)
Temp. range min	-40 °C
Temp. range max	100 °C
Glow wire test	750 °C
Thread type	M
Ø Connection thread D	20
Lead	1,5
Length screw-in thread L	10 mm
Ø cable diameter min	4 mm
Ø cable diameter max	14 mm
Key width SW	24 mm
Collar diameter (E)	27 mm
Total length TL	36 mm - 45 mm
Type of cable anchorage	A
Install. torques fitting	4 N/m
Install. torques fitting/EADR	3 N/m
Install. torques cap nut	3 N/m
Advice	With reduction insert
Product Color	RAL 9005
Type	GLP20+RDE black
UK-Number	10100636
WISKA-Order no.	10100636
Packing unit	10

Your Contact:

WISKA UK Ltd.

Unit 7, Hurling Way · St. Columb Major Business Park · TR9 6SX, St. Columb Major, Cornwall · Great Britain

☎ +44-12-08816062 · 📠 +44-12-08816708

info@wiska.co.uk · www.wiska.co.uk



Tariff number	39269097
EAN number	4007685047814
ETIM-Classification	EC000441

05.07.2022

Your Contact:

WISKA UK Ltd.

Unit 7, Hurling Way · St. Columb Major Business Park · TR9 6SX, St. Columb Major, Cornwall · Great Britain

 +44-12-08816062 ·  +44-12-08816708

info@wiska.co.uk · www.wiska.co.uk



Your Contact:

WISKA UK Ltd.

Unit 7, Hurling Way · St. Columb Major Business Park · TR9 6SX, St. Columb Major, Cornwall · Great Britain

☎ +44-12-08816062 · 📠 +44-12-08816708

info@wiska.co.uk · www.wiska.co.uk