



# CorePro LED PLC 4P

## CorePro LED PLC 6.5W 840 4P G24q-2

The CorePro LED PLC 4P integrates a LED light source into a traditional fluorescent form factor. This product is the ideal solution for uplamping in general lighting applications: it meets basic lighting requirements, offers significant energy savings and is environmentally friendly.

### Product data

General Information		Warm-up time to 60% light (nom.)	
Cap base	G24Q-2 [ G24q-2]		0.5 s
EU RoHS compliant	Yes	Power factor (nom.)	0.9
Nominal lifetime (nom.)	30000 h	Voltage (Nom)	20-50 V
Switching cycle	50,000X		
Light Technical		Temperature	
Colour code	840 [ CCT of 4,000 K]	T ambient (max.)	35 °C
Beam Angle (Nom)	120 °	T ambient (min.)	-20 °C
Luminous flux (nom.)	700 lm	T storage (max.)	65 °C
Colour designation	Cool White (CW)	T storage (min.)	-40 °C
Correlated Colour Temperature (Nom)	4000 K	T-Case maximum (nom.)	66 °C
Luminous efficacy (rated) (nom.)	92.31 lm/W	Controls and Dimming	
Colour consistency	<6	Dimmable	No
Color rendering index (nom.)	83	Mechanical and Housing	
LLMF at end of nominal lifetime (nom.)	70 %	Product length	100 mm
Operating and Electrical		Approval and Application	
Input frequency	30000-80000 Hz	Energy efficiency label (EEL)	A+
Power (Rated) (Nom)	6.5 W	Energy-saving product	Yes
Lamp current (max.)	300 mA	Approval marks	CE marking RoHS compliance KEMA Keur certificate
Lamp current (min.)	150 mA		
Starting time (nom.)	0.5 s		

# CorePro LED PLC 4P

Energy Consumption kWh/1000 h	9 kWh
<b>Product Data</b>	
Full product code	871869654121000
Order product name	CorePro LED PLC 6.5W 840 4P G24q-2
EAN/UPC – product	8718696541210
Order code	54121000

Numerator – quantity per pack	1
Numerator – packs per outer box	10
Material no. (12NC)	929001201102
Net weight (piece)	0.078 kg

## Dimensional drawing

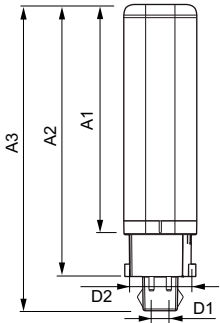

LEDtube PLC 6.5W G24q-2/840 4P

Product	D1	D2	A1	A2	A3
CorePro LED PLC 6.5W 840 4P G24q-2	24.3 mm	28.4 mm	105.8 mm	125 mm	140.6 mm

## Photometric data

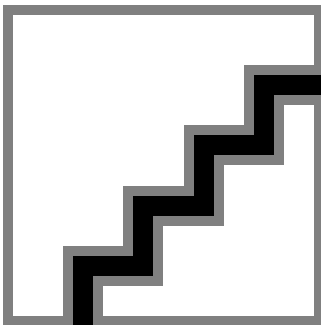

LEDtube PLC 100mm 7W G24Q-2 840 700lm

LEDtube PLC 100mm 9W G24Q-3 840 1000lm

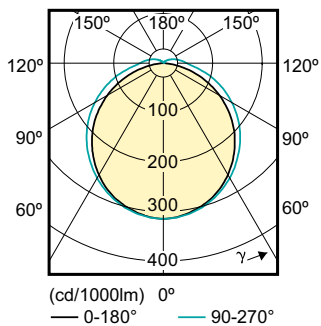

# CorePro LED PLC 4P

## Lifetime

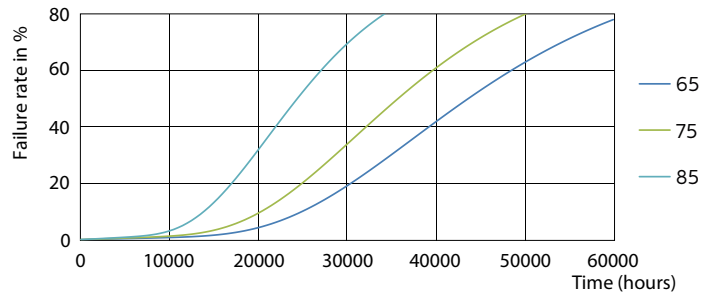
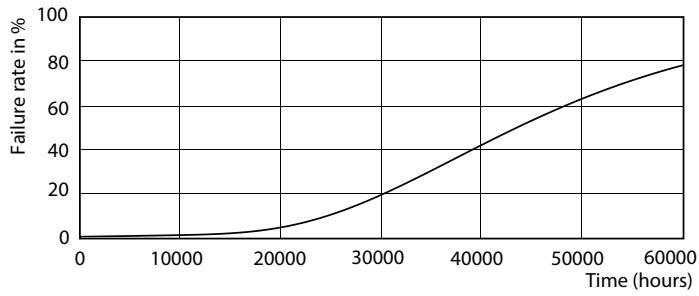

LEDtube PLC 100mm 7W G24Q-2 830 650lm

LEDtube PLC 100mm 7W G24Q-2 830 650lm

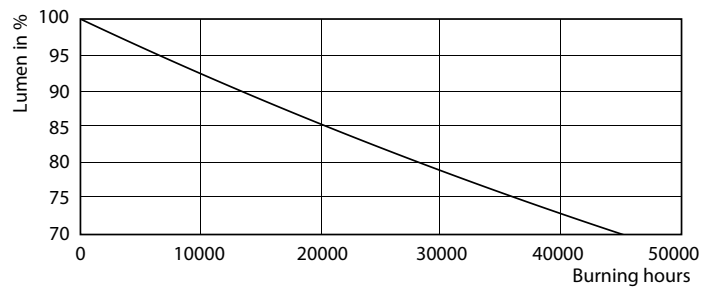
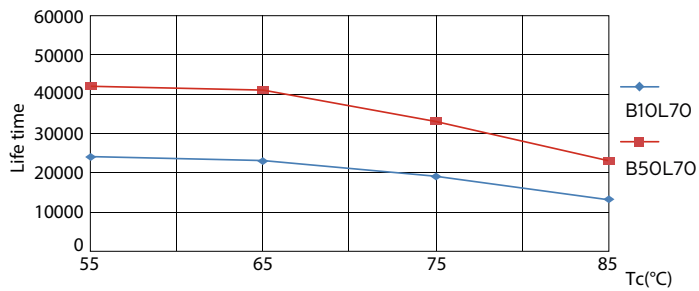

LEDtube PLC 100mm 7W G24Q-2 830 650lm

LEDtube PLC 100mm 7W G24Q-2 830 650lm

LEDtube PLC 100mm 7W G24Q-2 830 650lm

## CorePro LED PLC 4P

