



MASTER LEDspot ExpertColor AR111



MAS LEDspotLV D 20-100W 927 AR111 45D

The MASTER LEDspot LV ExpertColor creates a warm and comfortable ambience for hospitality venues, homes and restaurants. It creates ambience with superior lighting that has a customised spectrum, high CRI and deep dimming features. The result? A beautiful lighting experience. What's more, the innovative, trimless lens design will also suit almost any interior decor with its clean and neat look. In addition, you can take advantage of the full ExpertColor family, which also includes LEDspot LV and LEDspot Par lamps.

Product data

General information	
Cap base	G53 [G53]
EU RoHS compliant	Yes
Nominal lifetime (nom.)	25000 h
Technical type	20-100W
	Narrow Cone
Light technical	
Colour Code	927 [CCT of 2,700 K]
Beam Angle (Nom)	45 °
Luminous flux (nom.)	1270 lm
Luminous intensity (nom.)	2100 cd
Colour designation	Warm white (WW)
Correlated Colour Temperature (Nom)	2700 K
Luminous efficacy (rated) (nom.)	63.00 lm/W
Colour consistency	<4
Colour rendering index (nom.)	91
LLMF at end of nominal lifetime (nom.)	70 %

Luminous flux in 90° cone (rated)	1270 lm
Operating and electrical	
Input frequency	50 to 60 Hz
Power (Rated) (Nom)	20 W
Lamp current (nom.)	2000 mA
Wattage equivalent	100 W
Starting time (nom.)	0.5 s
Warm-up time to 60% light (nom.)	0.5 s
Power factor (nom.)	0.7
Voltage (Nom)	ac electronic 12 V
Temperature	
T-Case maximum (nom.)	97 °C
Controls and dimming	
Dimmable	Only with specific dimmers

MASTER LEDspot ExpertColor AR111

Mechanical and housing

Lamp Finish	Clear
Bulb shape	AR111

Approval and application

Energy Efficiency Class	G
Suitable for accent lighting	Yes
Energy consumption kWh/1,000 hours	20 kWh 648251

Product data

Full product code	871869970513800
-------------------	-----------------

Order product name	MAS LEDspotLV D 20-100W 927 AR111 45D
EAN/UPC – product	8718699705138
Order code	70513800
SAP numerator – quantity per pack	1
Numerator – packs per outer box	6
SAP material	929002050402
Net Weight (Piece)	0.160 kg

Dimensional drawing

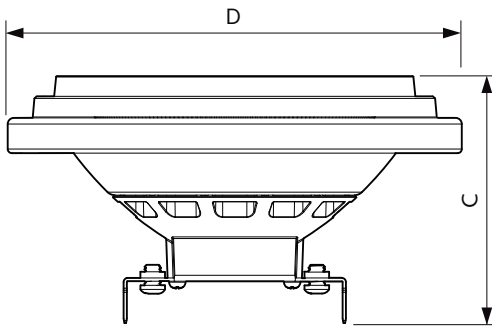

MAS LEDspotLV D 20-100W 927 AR111 45D

Product	D	C
MAS LEDspotLV D 20-100W 927 AR111 45D	111 mm	62 mm

Photometric data

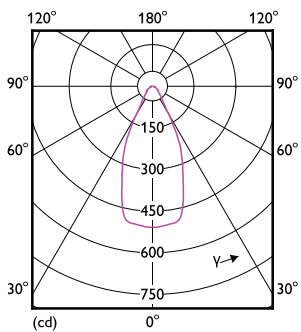

LEDspots MAS SLR 20W AR111 G53 927 45D-LDD LDD

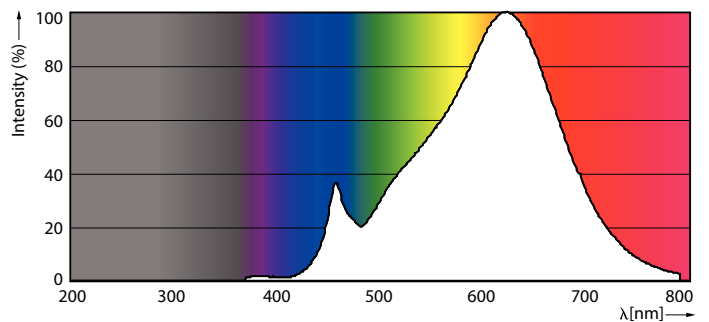

LEDspot 100W G53 AR111 927

MASTER LEDspot ExpertColor AR111

Photometric data

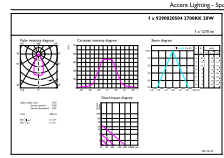
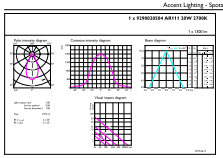

LEDspots 100W G53 AR111 927 45D

LEDspots MAS SLR 20W AR111 G53 927 45D-ADL ADL

Lifetime

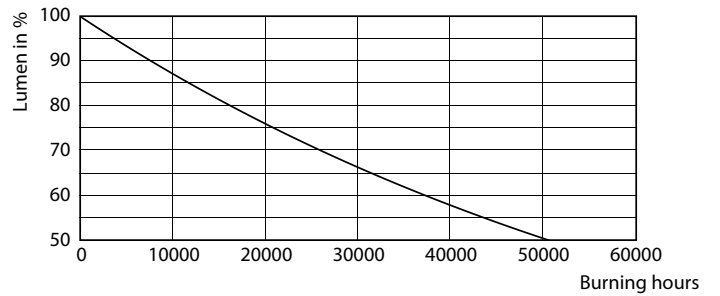
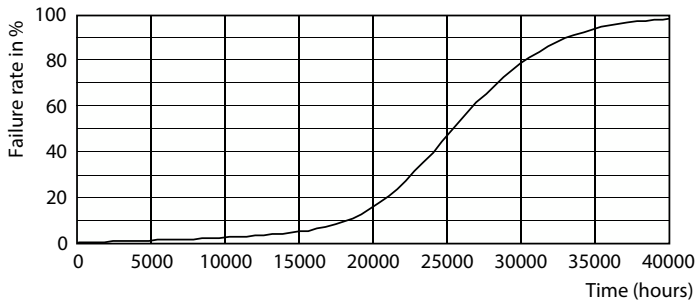

Life Expectancy Diagram

Lumen Maintenance Diagram

