

devola
Comfortable living everyday



Platinum 8" DC Pedestal Fan

DVPF8DCW / DVPF8DCB

Instruction Manual

devola.co.uk

Thank you for choosing Devola

Congratulations on the purchase of your new Devola product. Please read the following instructions carefully and follow them to prevent possible damages. We assume no liability for damage caused by disregard of the instructions and improper use.

Contents

Safety information	1
Product features	4
Operation	7
Cleaning and maintenance	9
Warranty	10



Please read this user manual carefully before operation.

Safety instructions

- **Use this appliance only as described in this manual.** Any other use may result in fire, electrical shock, or injury. This will also invalidate the warranty.
- This appliance may be used by children aged 8 years and older, as well as by individuals with reduced physical, sensory, or mental capabilities, or those lacking experience or knowledge, provided they have been properly supervised or instructed on the safe use of the appliance and understand the associated risks.
- **Children must not play with the appliance.** Cleaning and maintenance must not be carried out by children without appropriate supervision.
- **Children under the age of 3 must be kept away from the appliance at all times** unless under continuous supervision.
- **Children aged between 3 and 8 years may only switch the appliance on or off,** and only if it has been installed in its normal operating position and they have been supervised or instructed on its safe use and fully understand the potential hazards.
- **Children between 3 and 8 years of age must not plug in,** adjust settings, clean, or perform any maintenance on the appliance.
- Always connect the appliance to a **properly earthed 220-240V AC power supply.**
- Avoid using a high-wattage appliance on the same electrical circuit.
- **Do not use the appliance if the power cord or plug is damaged.** Contact the retailer.
- **Do not extend the power cord** or use extension leads.
- The socket outlet must be accessible at all times to enable the mains plug to be disconnected as quickly as possible.
- Avoid placing the power cable in areas where it may become a **tripping hazard.**
- **Do not pull, kink or wrap the power cable** around the appliance, as this may weaken the internal wires.
- This appliance is intended for indoor use only. Do not operate the appliance outdoors.
- **Place the appliance on a flat, stable surface** in an upright position. Operating in any other position could cause a hazard.
- **Never cover the appliance.** Covering it may cause it to overheat and catch fire.
- **DO NOT** place the appliance:
 - o Within 50cm of objects, such as curtains, furniture, paper, bedding.
 - o Within 1.5 metres of any flammable objects.
 - o With the safety guard removed.
- **Do not use in areas with flammable gases, vapours or dust** (e.g. garages or workshops).
- Ensure the appliance is **never positioned where it could fall into water.**
- Never operate the appliance with **wet hands** or pull the plug out by the cord.

- The switch or controller **must not be reachable from any bodies of water**.
- **Do not insert fingers or objects** into the appliance when in operation.
- **Do not leave the appliance on unattended** or while sleeping.
- Switch off the appliance and unplug from the mains before cleaning or repositioning.
- Only clean the appliance with a **soft cloth** - no solvents or abrasives.
- You may notice a faint odour when the appliance is used for the first time. This is completely normal and will fade within a few minutes.
- **Do not attempt to open**, repair or modify the appliance yourself. Contact the retailer.

Battery safety instructions

The remote control supplied with this appliance contains batteries. Please observe the following battery safety instructions.

- Use only the battery type specified in this manual.
- Insert batteries with the correct polarity (+ / -) as indicated.
- Remove batteries from the remote control if it will not be used for a long period.
- Do not expose batteries to heat, fire, or direct sunlight.
- If a battery leaks, avoid contact with skin or eyes. Dispose of the battery and clean the compartment before reuse.
- Keep batteries out of reach of children.
- Dispose of used batteries according to local recycling regulations. Do not dispose of batteries in household waste.

 **Warning:** Batteries can pose a risk of leakage, overheating, or explosion if used incorrectly.

Important Information	Possible signs of battery ingestion include:
<ul style="list-style-type: none"> • Battery ingestion may not cause obvious symptoms • A swallowed battery can become lodged in the oesophagus (food pipe) without being immediately detected • Symptoms may be mistaken for common illnesses 	<ul style="list-style-type: none"> • Coughing, gagging, drooling, or choking • Vomiting or feeling sick • Pointing to the throat or stomach • Chest, throat, or abdominal pain • Unusual tiredness, irritability, or lethargy • Loss of appetite or difficulty eating solid food

 **Warning:** Vomiting **fresh (bright red) blood** is a serious sign of button or coin battery ingestion.

If battery ingestion is suspected, seek immediate medical attention.

Do not induce vomiting or allow the child to eat or drink.

Warning

Failure to follow these instructions could lead to severe consequences, including explosion, property damage, injury, or even death.

To avoid danger of suffocation please remove all packaging materials particularly plastic and EPS and keep these away from vulnerable people, children and babies.

To avoid the risk of accidental strangulation from the supply cord all children and vulnerable people must be supervised when in the vicinity of the product whether it is working or not.

Specification	DVPF8DCW	DVPF8DCB
Voltage	220-240V	220-240V
Frequency	50/60Hz	50/60Hz
Power	18W	18W
Product Size (mm)	331 (W) 300 (D) 586-1058 (H)	331 (W) 300 (D) 586-1058 (H)
Product Weight	4.0Kg	4.0Kg
Colour	White	Black

Note: The images and illustrations in this user manual are provided for demonstration purposes only. Actual product design, features, and appearance may vary slightly depending on the model or specification.

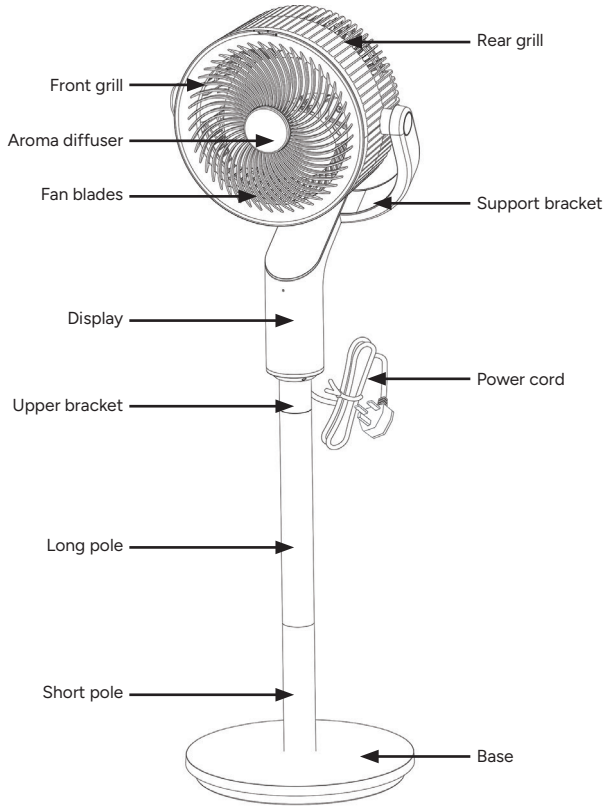

Product contents

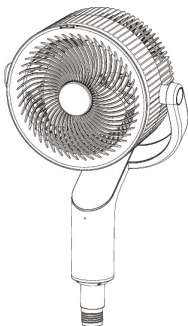

Fan



Long pole



Short pole



Base



Base plate nut



Remote control



User manual

The fan features adjustable height settings for flexible use. Assemble the supplied poles to achieve your preferred height.

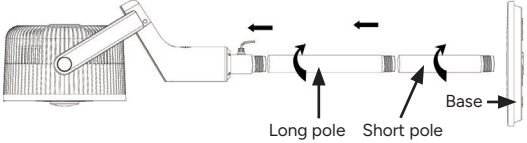
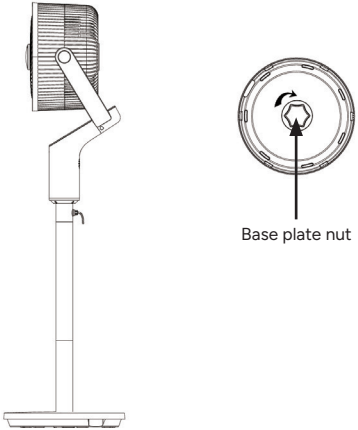
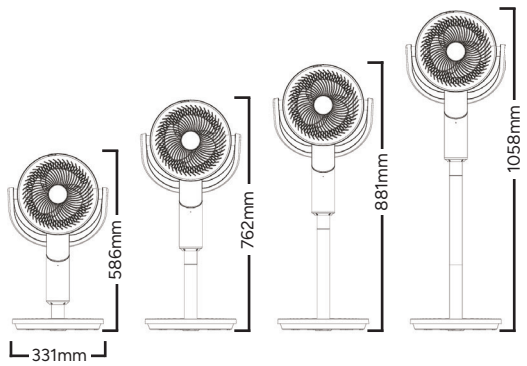
<p>Place the fan head on a flat surface, install the pole by turning it counter-clockwise until secure.</p>	
<p>Align the threaded end of the pole with the hole in the base plate, then tighten the base plate nut to secure it.</p>	
<p>Note: The poles are detachable. The fan head can be attached directly to the base plate and used as a table fan.</p>	

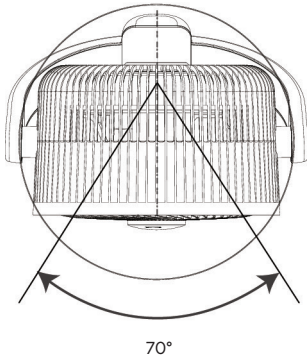

Left and right oscillation
The fan automatically oscillates left and right up to 70°.

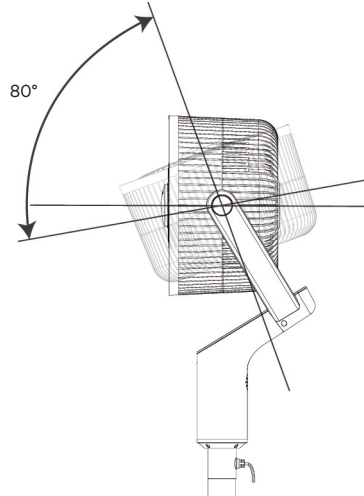

Up and down oscillation
The fan automatically oscillates up and down up to 80°.

Aroma diffuser instructions

- The front grille decorative cover contains a built-in aroma diffuser.
- When installing the aroma diffuser, align the slot with the groove on the front grille. A “click” sound indicates it is correctly installed.





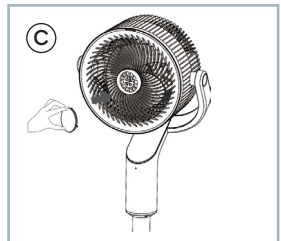
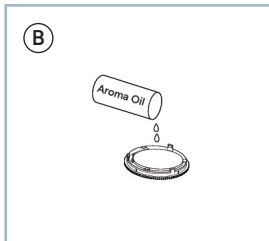
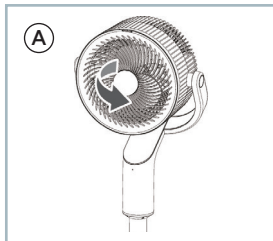

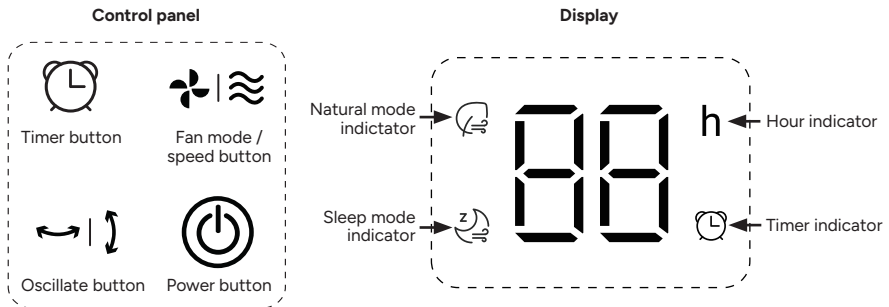



To add fragrance:

- Rotate or press the front grille decorative cover to remove it from the fan.
- Add a few drops of aroma oil into the aroma diffuser.
- Align the aroma diffuser with the groove on the front grille and reinstall it, turning clockwise until it clicks into place (see diagram below).





	Power	<ul style="list-style-type: none"> • ON/OFF: Press to turn the fan on or off.
	Fan Speed	<ul style="list-style-type: none"> • SPEED: Press to cycle through the 12 fan speed levels
	Fan Mode	<p>Fan modes can be selected by pressing and holding the fan button to cycle through each mode.</p> <p>The fan has three fan modes:</p> <ul style="list-style-type: none"> • Normal (Default): Provides a steady airflow. Fan speed remains constant and can be adjusted between levels 1–12. • Nature: Automatically varies the fan speed to simulate a natural sea breeze. The natural mode indicator will appear when activated. • Sleep: Gradually reduces the fan speed by one level every 30 minutes for quieter operation. This mode is ideal for use with the timer to prevent sleep disturbance. The natural mode indicator will appear when activated.
	Oscillation (OSC)	<ul style="list-style-type: none"> • Press the OSC button to control fan movement: <ol style="list-style-type: none"> 1. First press: Vertical and horizontal oscillation enabled. 2. Second press: Horizontal oscillation only. 3. Third press: Vertical oscillation only. 4. Fourth press: All oscillation functions off; fan remains fixed in position. • Important: Do not adjust the oscillation angle by hand.
	Timer ON (Standby Mode)	<ul style="list-style-type: none"> • When the fan is in standby, press the timer button to schedule a start time. • Timer range: 1–15 hours in one-hour intervals. • For timers longer than one hour, the displayed time will reduce hourly to reflect the remaining duration. • Note: Switching the fan on or off after setting the timer will cancel the scheduled timer.
	Timer OFF (Fan On)	<ul style="list-style-type: none"> • When the fan is operating, press the timer button to set an automatic shut-off time. • Timer range: 1–15 hours in one-hour intervals. • The display alternates between the current fan speed and the remaining time until the fan switches off. • The displayed time will reduce hourly for timers set longer than one hour. • Note: Turning the fan off and back on will cancel the scheduled timer.

	Power button
	Light button
	Fan speed / Fan button
	Timer ON (Standby mode only)
	Timer OFF (Fan on)
	Left to right oscillation
	Up and down oscillation
	Speed control buttons
	
	Sound control button

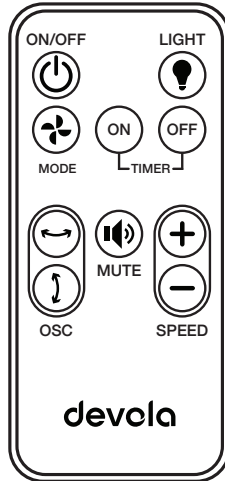

Battery safety

- Use new CR2025 batteries only.
- Do not modify, short-circuit, or disassemble batteries.
- Follow the battery replacement instructions on the back of the remote control.
- Remove batteries if the remote control is not used for a long time.

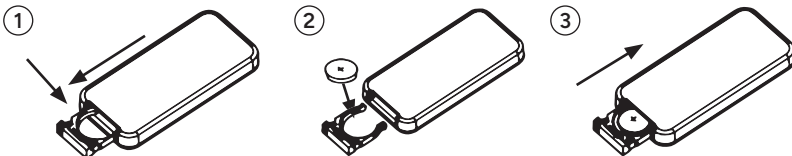

Please follow the cleaning and maintenance instruction carefully. Failure to follow these guidelines may void your warranty.

Cleaning the appliance

- Always switch off the appliance and unplug it from the socket before cleaning.
- Use a duster or soft dry cloth to clean the body of the fan and safety grill.
- Do not immerse any part of the fan in water or liquid.
- Operating the appliance in an unclean or obstructed condition may lead to damage or reduced performance and may void the warranty.

Storage

If the appliance will not be used for an extended period, especially in humid or coastal areas, make sure it is:

- Fully cleaned and dried.
- Stored in safe packaging to protect against dust and moisture, ideally in the original packaging.
- Kept in a dry, indoor location out of reach of children.
- The power cord can be wrapped around the base of the fan.
- By following these steps, you'll help maintain the performance, appearance, and safety of your appliance for years to come.

Repairs and servicing

- The appliance contains no user-serviceable parts.
- Do not attempt to repair or modify any electrical or mechanical components.
- If the appliance is damaged, defective, or not working correctly, contact the retailer.

Extend your Devola warranty for free

Register your product within 30 days of purchase

When you register your Devola product on our website within 30 days of purchase, we'll extend your standard manufacturer's warranty by an additional 12 months from the point of purchase - completely free of charge.

Register on the Devola website using the QR code below



If your product develops a fault within the warranty period, we'll either:

- Repair it at no extra cost
- Replace it with a new or refurbished item of similar condition
- Cover any necessary postage costs

Please note:

- The warranty does not cover issues caused by general wear and tear, improper use, or damage not resulting from defects in materials or workmanship.
- Tampering with or opening the product will void your warranty.

If something goes wrong, get in touch with our **Customer Care Team** first. They'll guide you through the warranty process and ensure things are resolved smoothly.



Recycle unwanted materials instead of disposing of them. All appliances and packaging should be sorted and tendered at a regional recycling centre and be processed in an environmentally friendly manner.

Product registration

Register your warranty online
within 30 days of purchase.

www.devola.co.uk/warranty

Technical details



Support

Address

Unit 1, Reedswood Park Road
Walsall WS2 8DQ

Helpline

0800 043 4243

Email

info@devola.co.uk

devola.co.uk