

INSTALLATION MANUAL

Eastbrook Road, Gloucester GL4 3DB
Technical Helpline: 01452 317890
email: technical@eastbrookco.com

Eastbrook Code	Adjustment	Eastbrook Code	Adjustment
69.0047	490-500	69.0048	690-700
69.0049	750-760	69.0050	790-800
69.0051	890-900	69.0052	990-1000
69.0053	1190-1200	69.0054	1390-1400

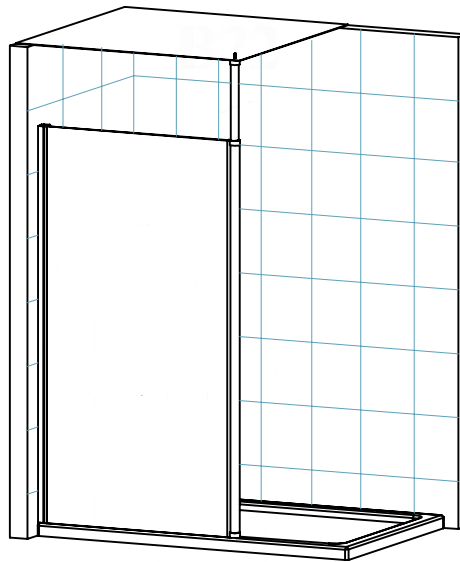

F010

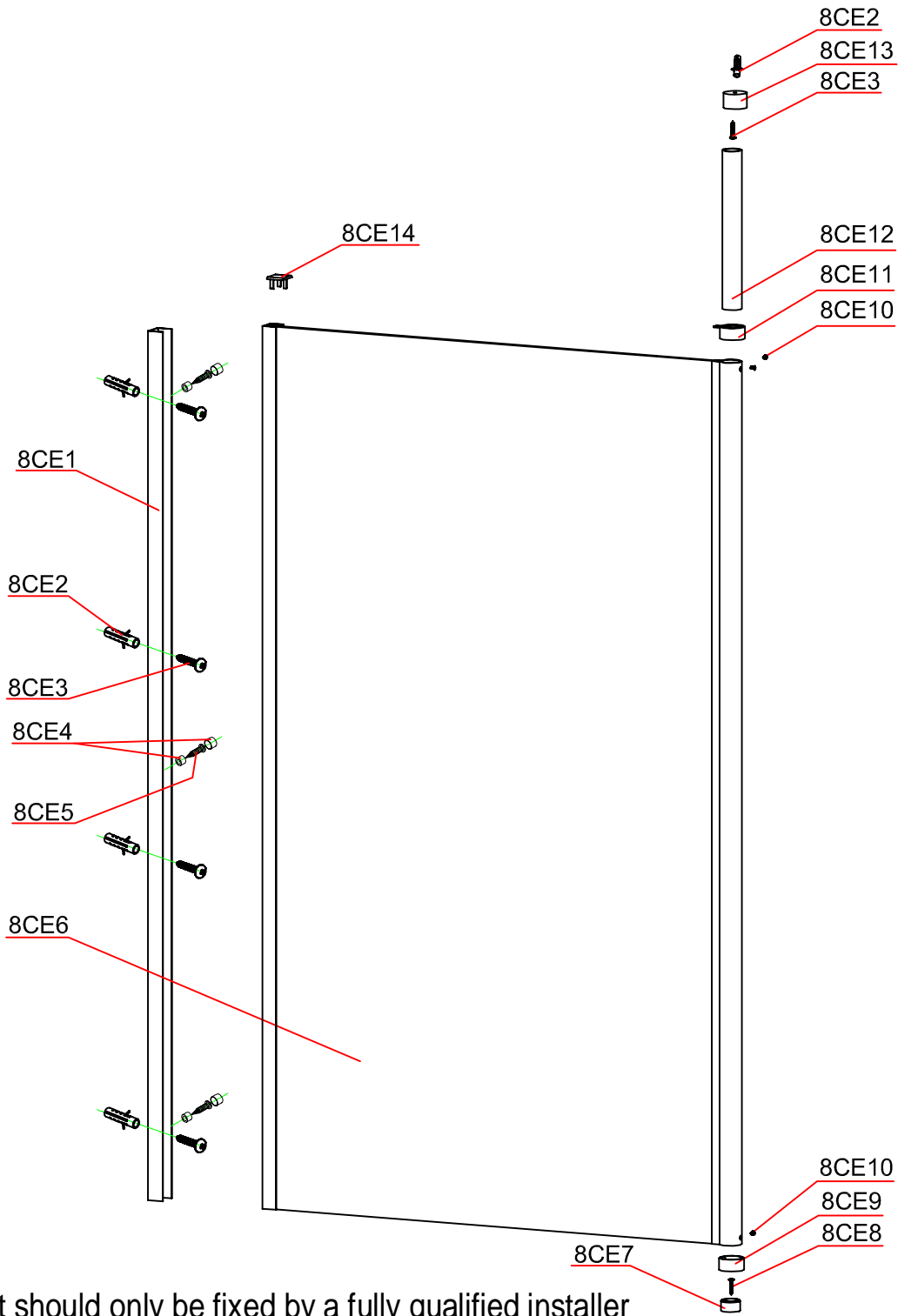

This product should only be fixed by a fully qualified installer

<p>8CE1</p> <p>1X</p>	<p>8CE2</p> <p>5X</p>	<p>8CE3</p> <p>30 ST4</p> <p>5X</p>	<p>8CE4</p> <p>3X</p>	<p>8CE5</p> <p>10 ST4</p> <p>3X</p>	<p>8CE7</p> <p>1X</p>	<p>8CE8</p> <p>16 ST4</p> <p>1X</p>
<p>8CE9</p> <p>1X</p>	<p>8CE10</p> <p>12 ST4</p> <p>3X</p>	<p>8CE11</p> <p>2X</p>	<p>8CE12</p> <p>1X</p>	<p>8CE13</p> <p>1X</p>	<p>8CE14</p> <p>1X</p>	

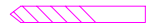
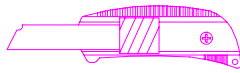
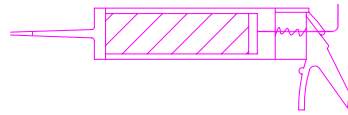
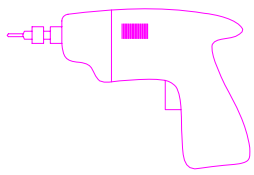

ø6

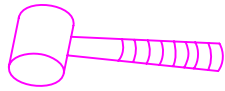
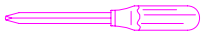

ø3.2

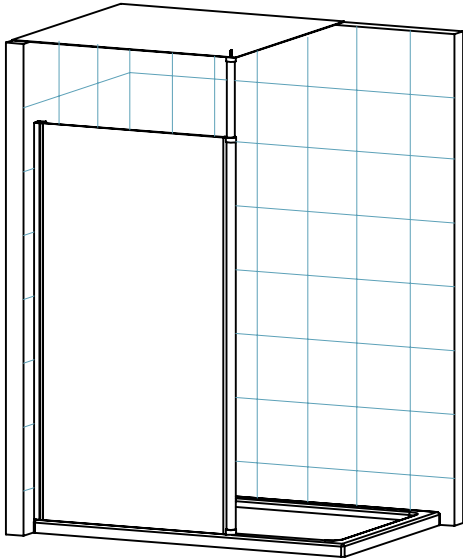

LH

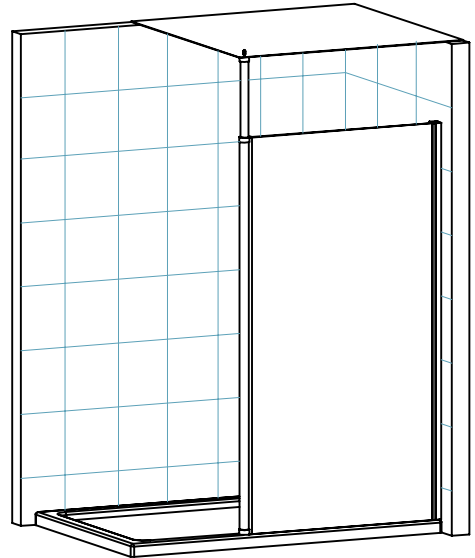

RH

1L

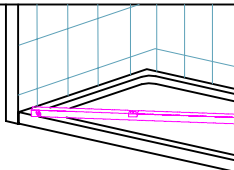
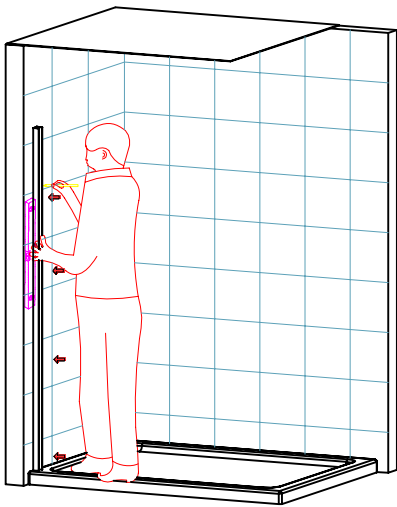

12mm

1.1

8CE1

1R

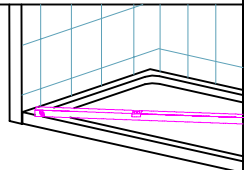
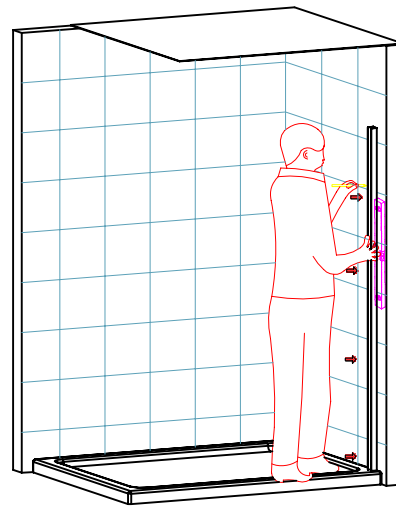

12mm

1.1

8CE1

2L

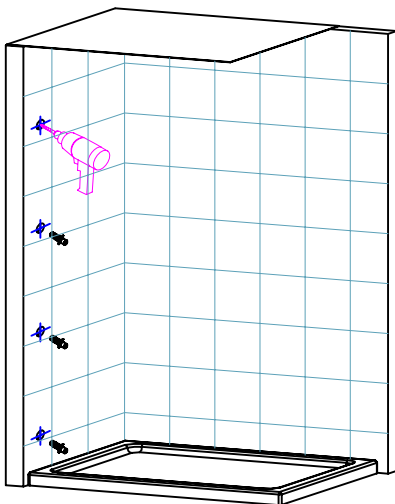

2.1

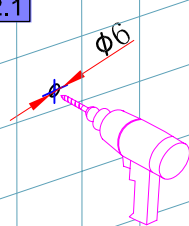

8CE2(4X)

2.2

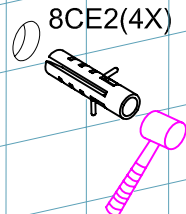

2R

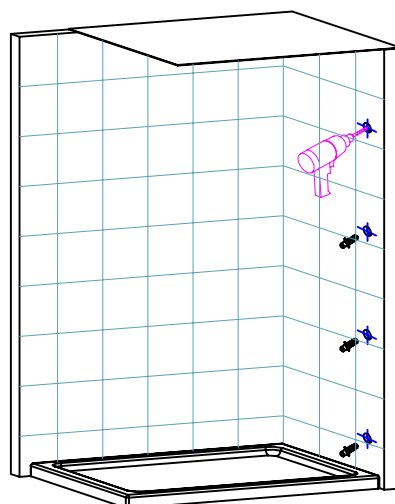

2.1

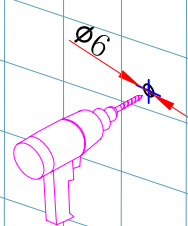

8CE2(4X)

2.2

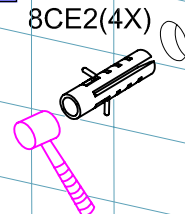

3L

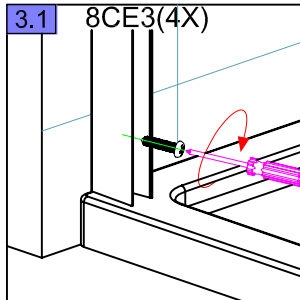
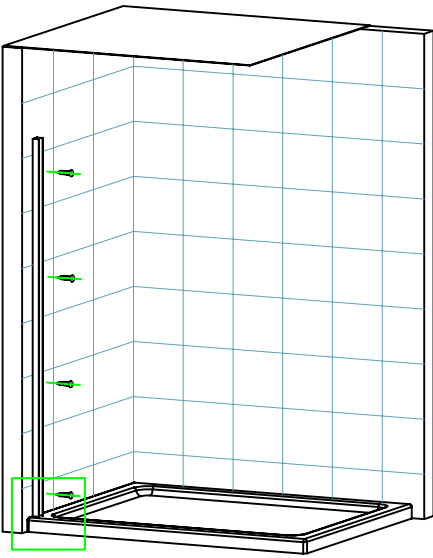

3R

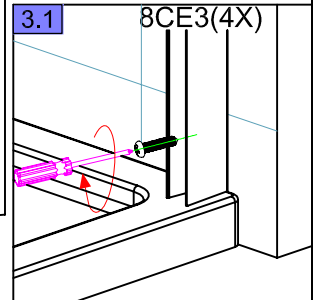
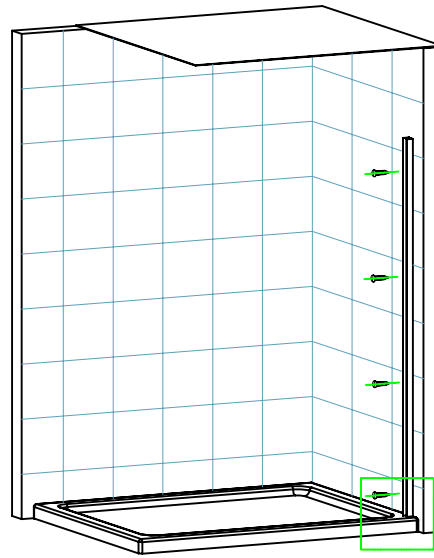

4L

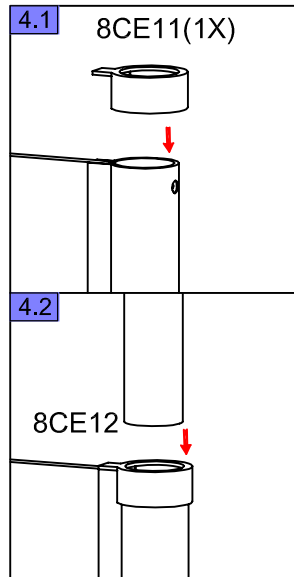
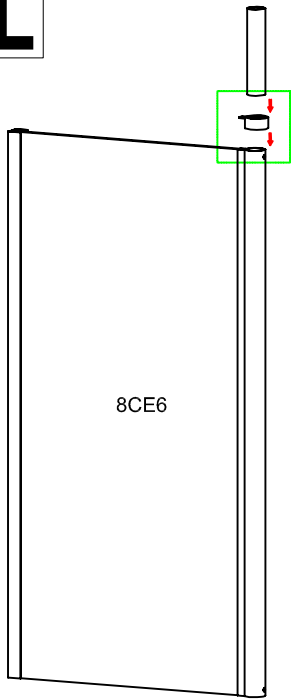

4R

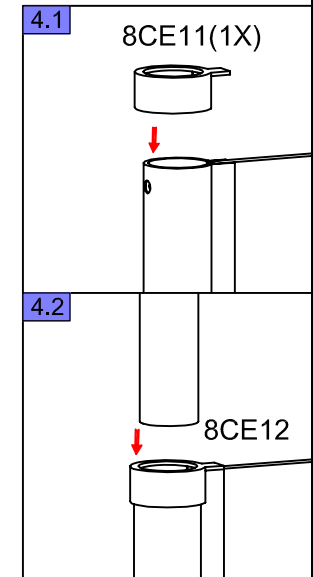
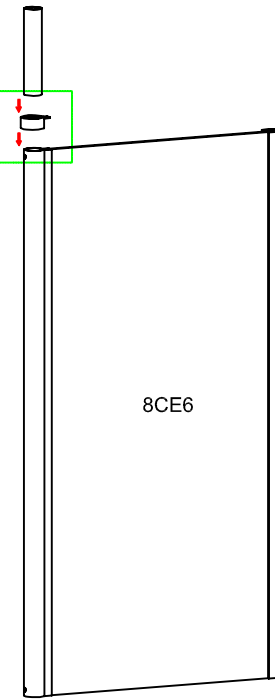

5L

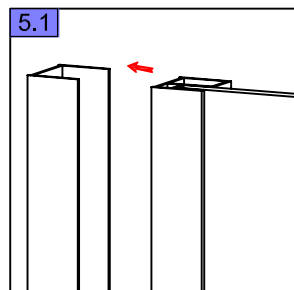
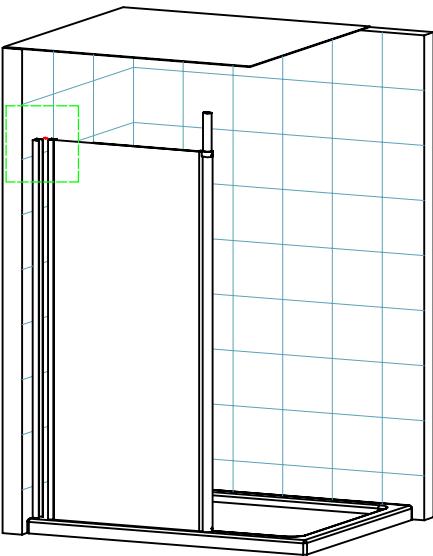

5R

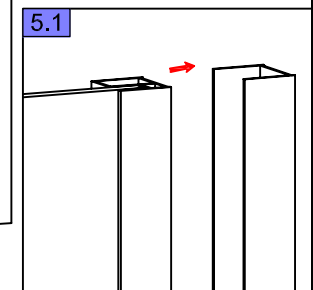
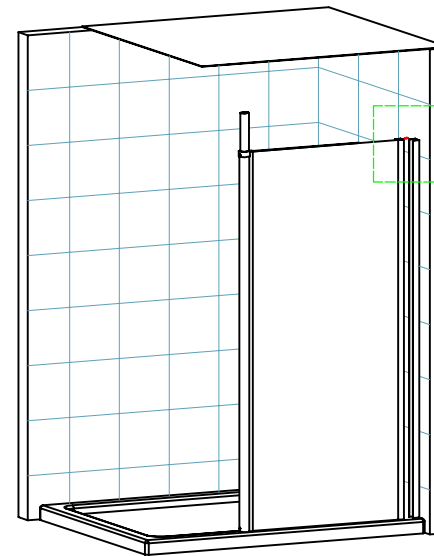

6L

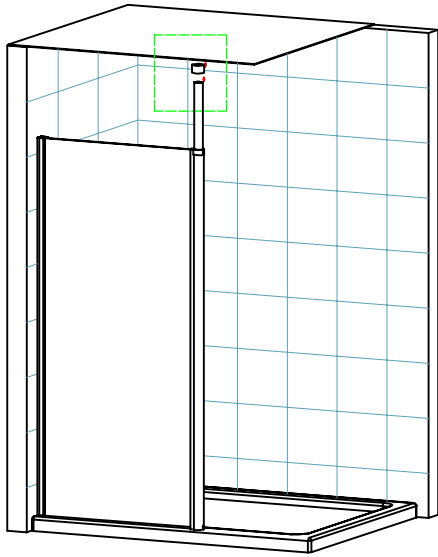

6.1

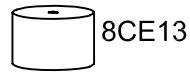

6.2

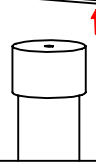

6.3

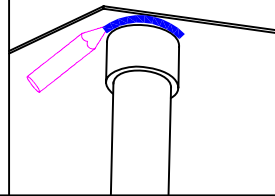

6R

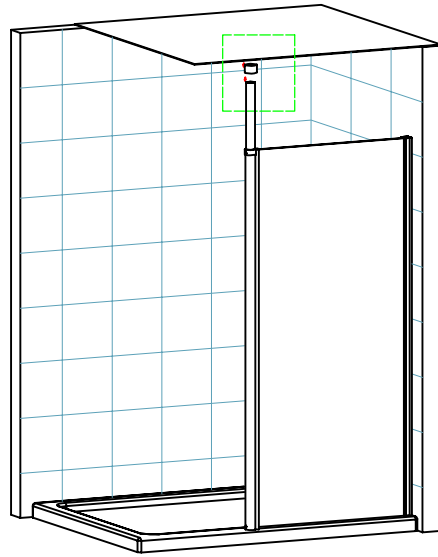

6.1

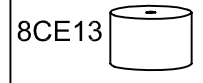

6.2

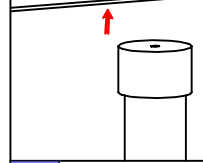

6.3

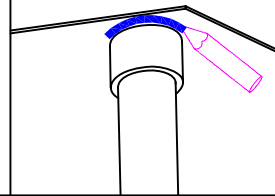

7L

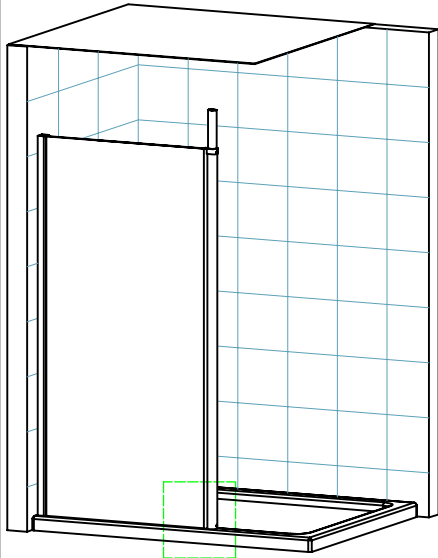

7.1

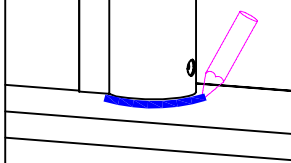

7R

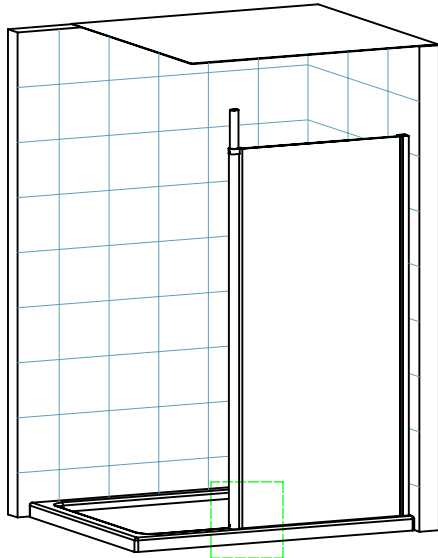

7.1

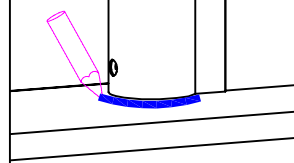

8L

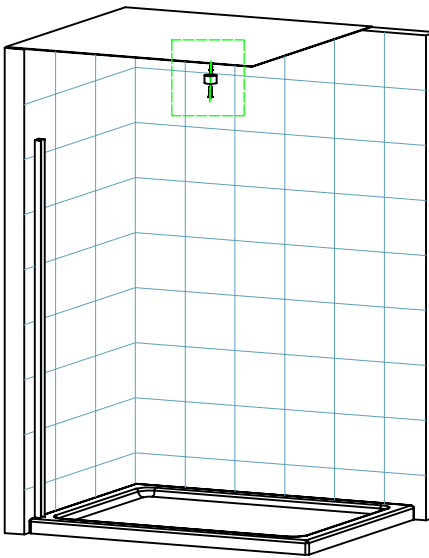

8.1

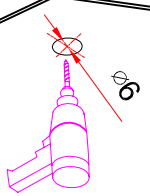

8.2

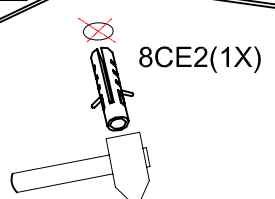

8.3

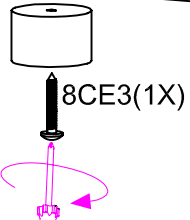

8R

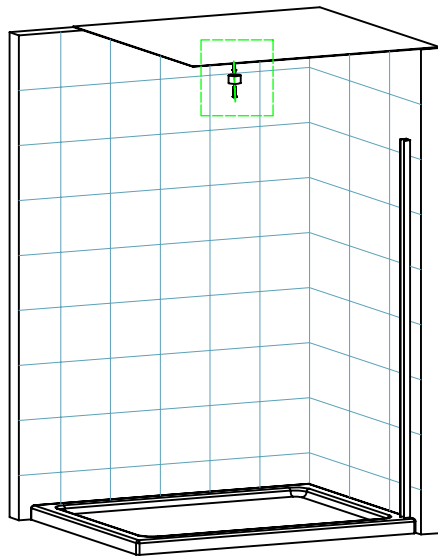

8.1

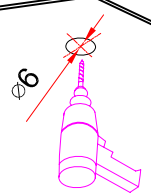

8.2

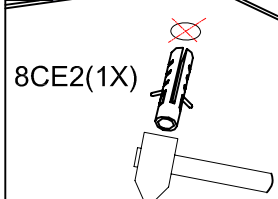

8.3

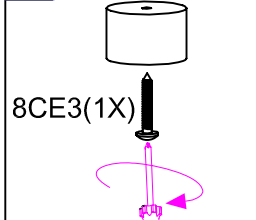

9L

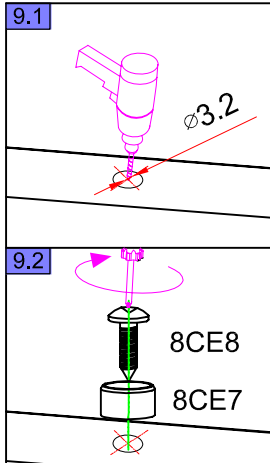
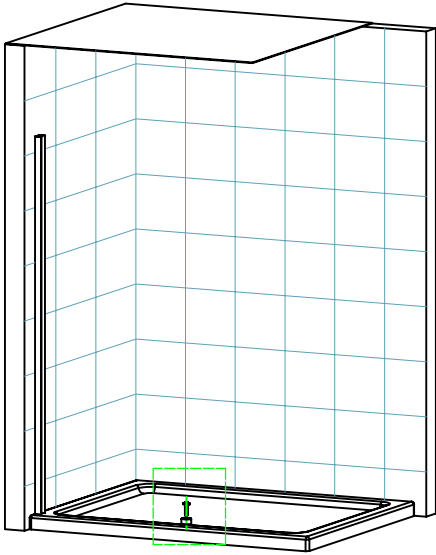

9R

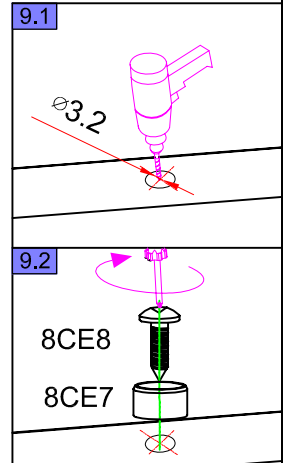
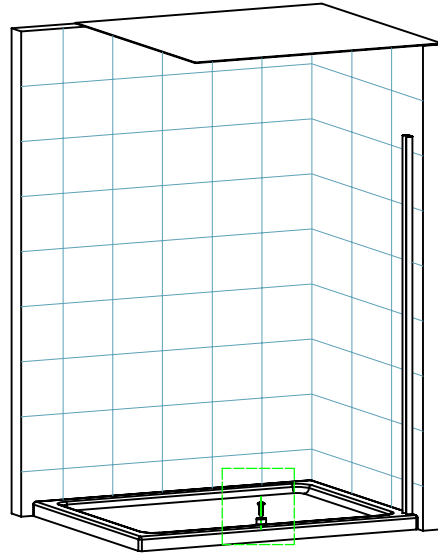

10L

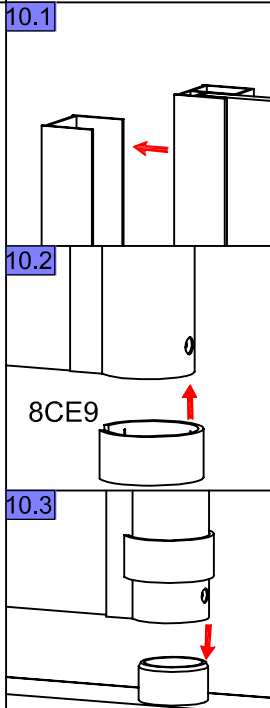
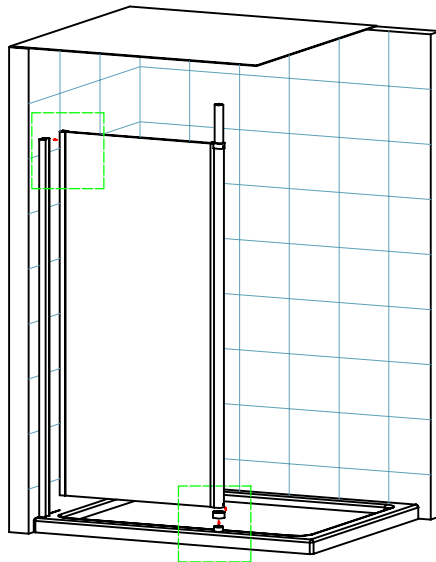

10R

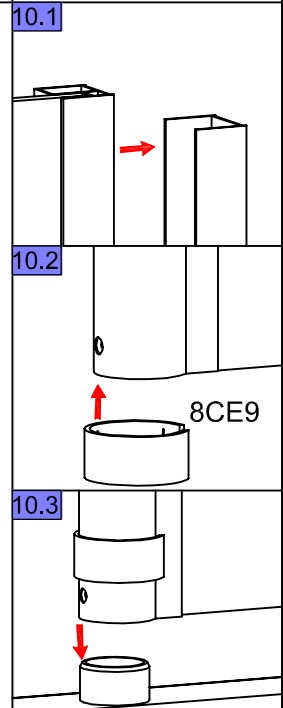
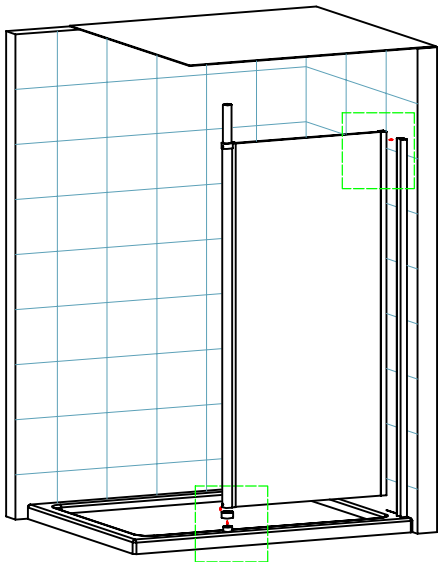

11L

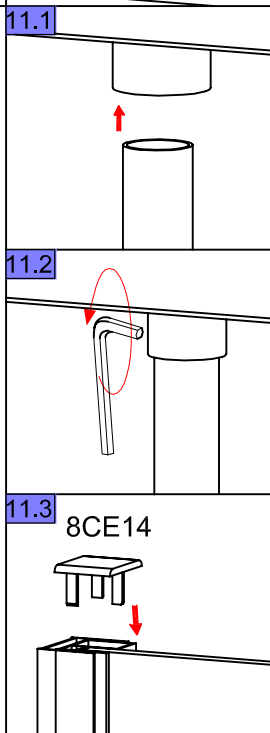
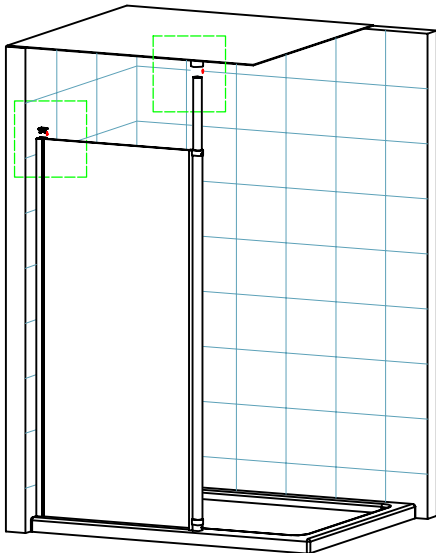

11R

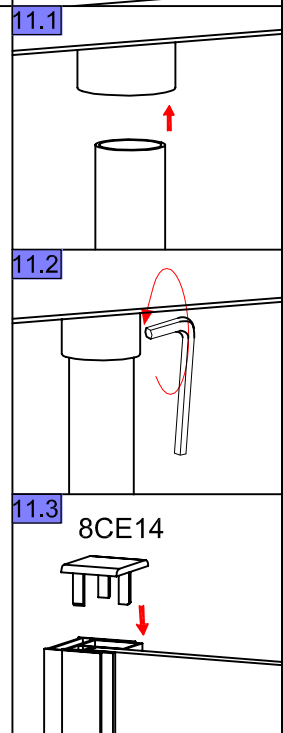
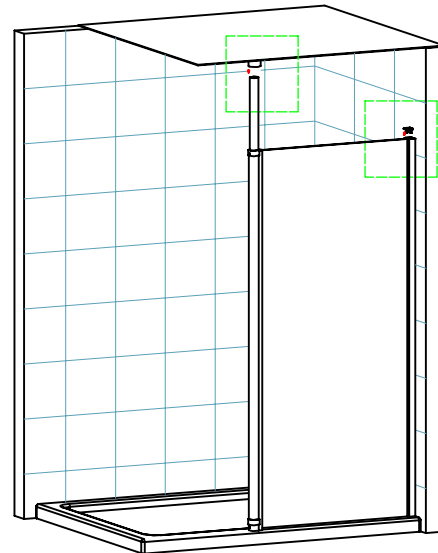

12L

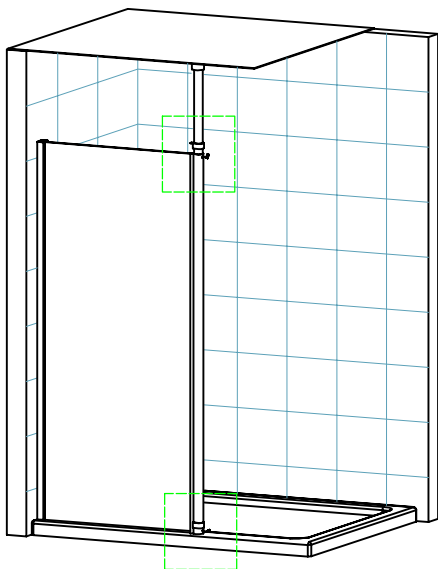

12.1

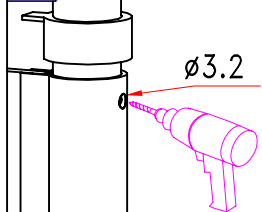

ø3.2

12.2

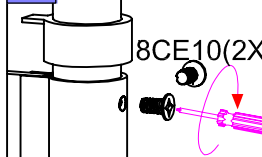

8CE10(2X)

12.3

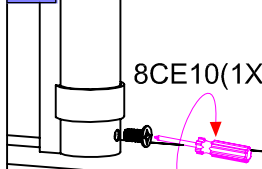

8CE10(1X)

12R

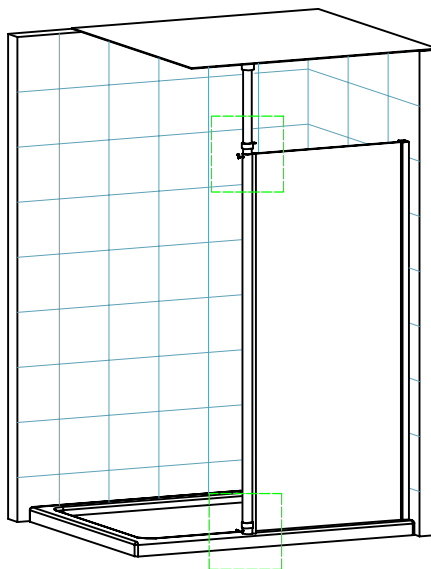

12.1

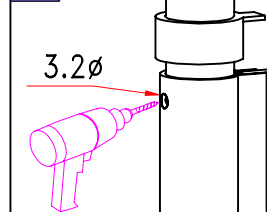

3.2ø

12.2

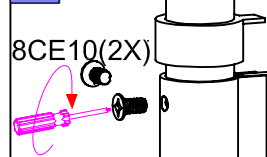

8CE10(2X)

12.3

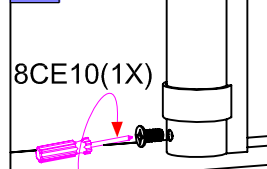

8CE10(1X)

13L

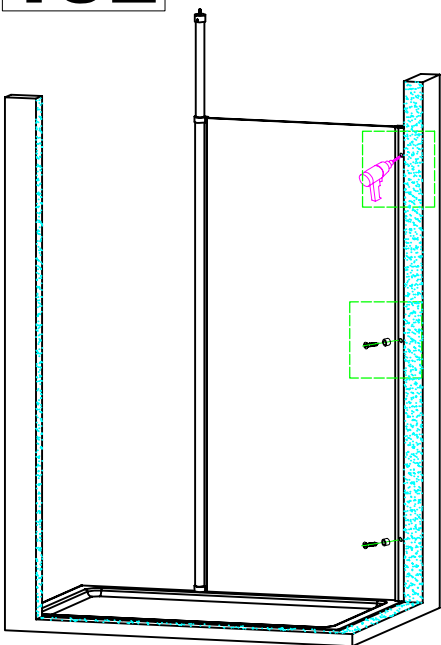

13.1

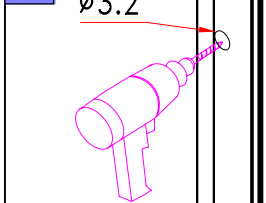

ø3.2

13.2

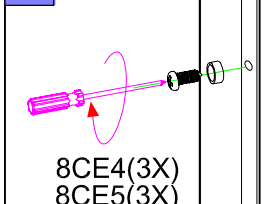

8CE4(3X)
8CE5(3X)

13.3

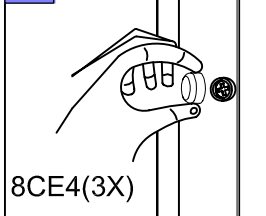

8CE4(3X)

13R

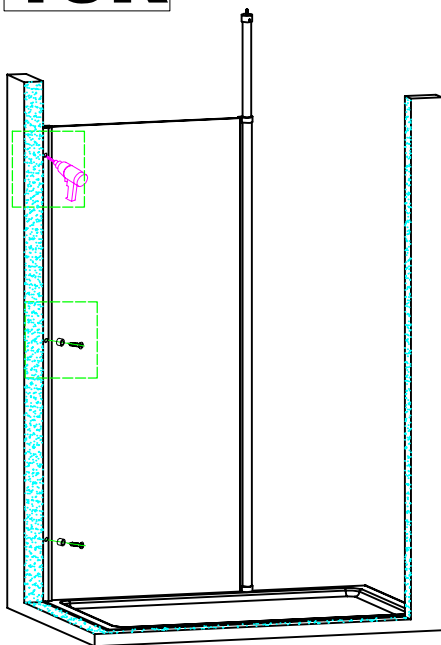

13.1

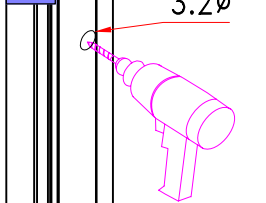

3.2ø

13.2

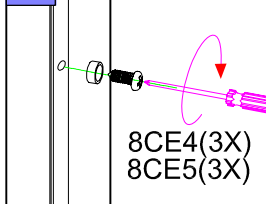

8CE4(3X)
8CE5(3X)

13.3

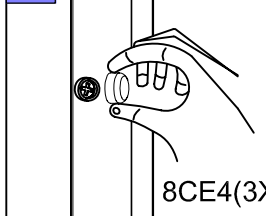

8CE4(3X)

14L

Silicone on the outside of the screen only

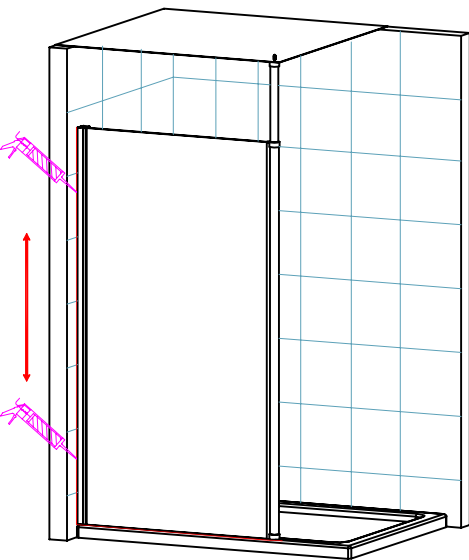
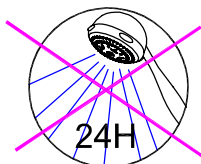

14.1

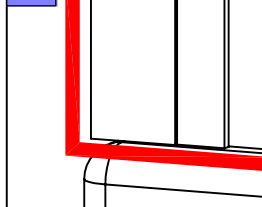

14R

Silicone on the outside of the screen only

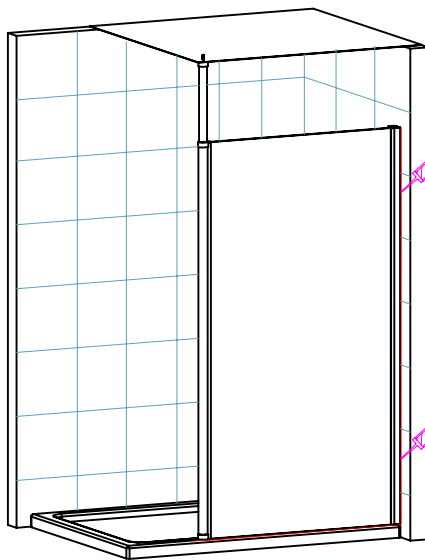
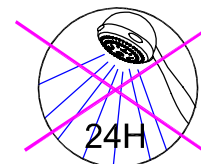

14.1

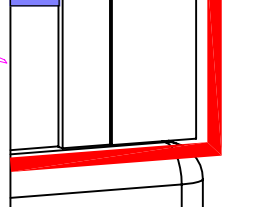

Cleaning & Maintenance

Don't clean the shower enclosure with irritant detergent such as alcohol,bleach or other chemical cleaners.

Only clean with warm soapy water.

After the installation is completed,should you find that there is notable noise when the glass door moves,you may add a small quantity of lubricant onto the roller wheel,slipping hook and the track.

Helpline: 01452 317890