

Installation Manual for Side Panel with Towel Rail.

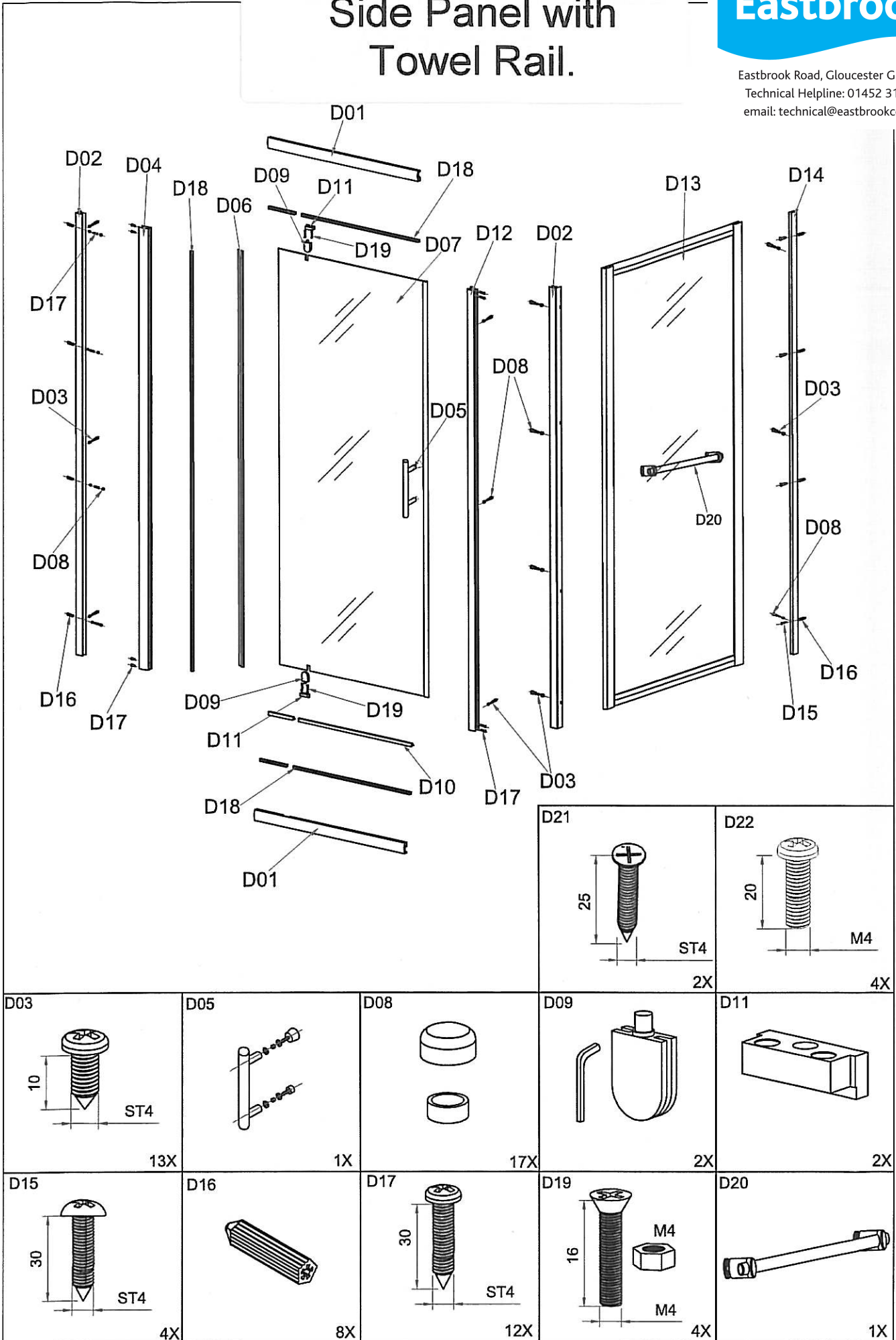

Eastbrook Road, Gloucester GL4 3DB
 Technical Helpline: 01452 317890
 email: technical@eastbrookco.com

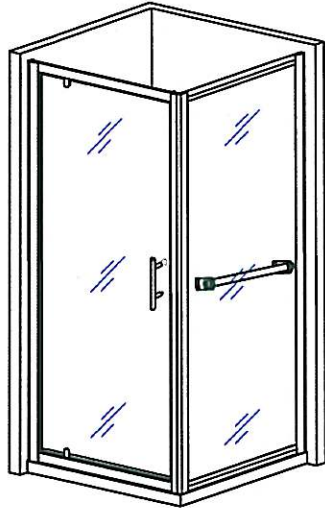

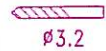
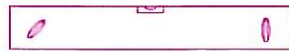
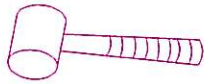
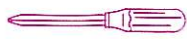
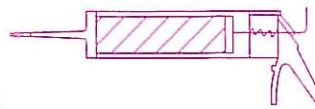
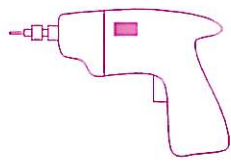

L

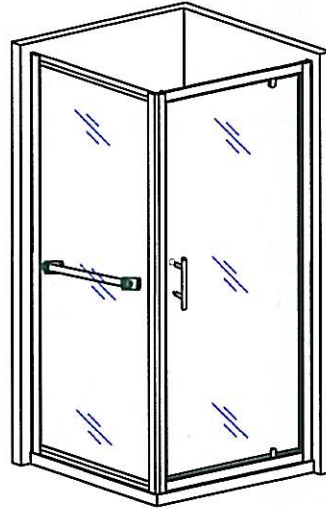

R

1

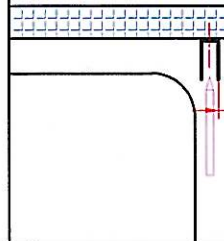
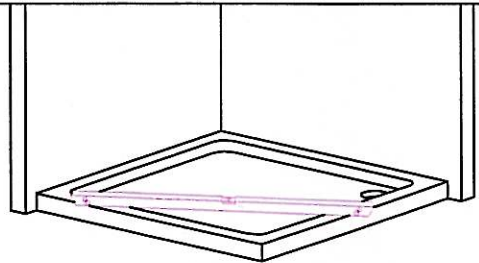
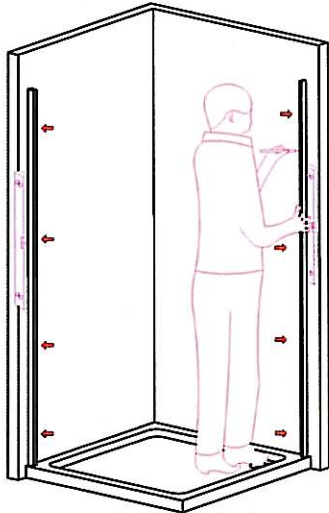

10

D14

D02

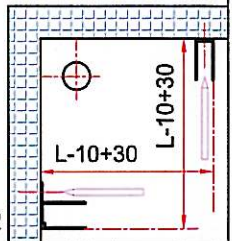

2

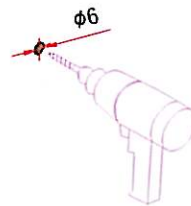
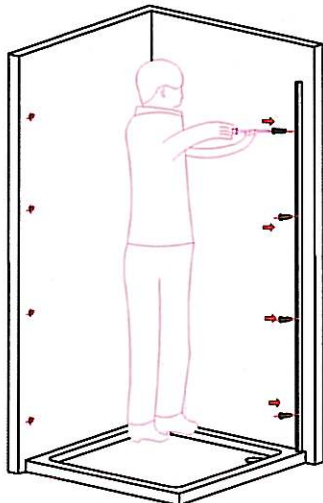

$\phi 6$

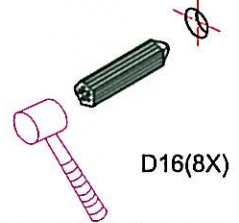

D16(8X)

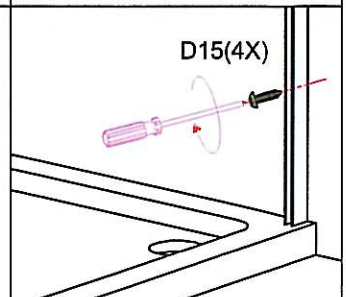

D15(4X)

