

DATASHEET

Image



General Information

Product:	8.004
Description:	150 watt Type A element
Website Link:	(Click Here)
Product Type:	Heating Element
Brand:	Eastbrook Company
Colour:	White
Material:	
Net Weight (kg):	0.5kg
Product Range:	Type A Element

Product Specifications

Warranty:	1 Year(s)
Orientation:	
Watts:	150
Valve Types:	

Drawing

Type A Element Technical Drawing

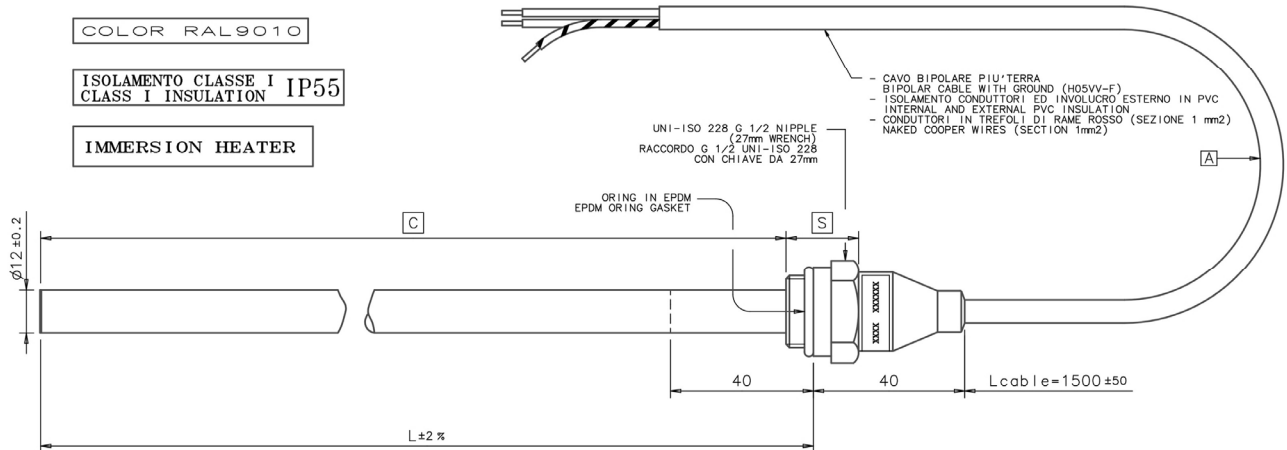

APPLICATION AND WARNING

ASSEMBLY - THE HEATER CAN BE ASSEMBLED VERTICALLY OR HORIZONTALLY IN THE TOWEL RAIL OR RADIATOR. IN THE CASE OF ANY DAMAGE TO THE ELECTRICAL CONNECTIONS, THE HEATER MUST BE RETURNED TO THE SUPPLIER OR BE SERVICED BY A QUALIFIED ELECTRICIAN. DO NOT ALTER ANY OF THE FACTORY FITTED ELECTRICAL CONNECTIONS. FOR HEATERS FITTED WITHOUT A FEED PLUG, AN ISOLATING DEVICE ENSURING DISCONNECTION FROM THE CIRCUIT MUST BE FITTED. THERE MUST BE AT LEAST 3mm BETWEEN CONTACTS WHEN IN THE OPEN POSITION. RESIDUAL CURRENT CIRCUIT BREAKER (RCCB) SHOULD BE FITTED IN LINE WITH THE CURRENT TEE REGULATIONS.

NORME DI RIFERIMENTO PER COSTRUZIONE E TEST ELETTRICI: CEI EN 60335-1
 REFERENCE STANDARDS FOR CONSTRUCTION AND ELECTRICAL TESTING: CEI EN 60335-1

TEMPERATURE MASSIME	
ZONA	°C
C	100
S	100
A	70

Eastbrook
 Eastbrook Road, Gloucester GL4 3DB
 Technical Helpline : 01452 317890
 Mon - Fri / 8am - 5pm
 Email : technical@eastbrookco.com