

▶ Critical Dimension	Perspective drawing	Tolerance grade not noted	Basic size	$0 < a \leq 120(4.72")$	$120(4.72") < a$	Note the Angle tolerance
▶ Most important dimensions	1		Tol Value	$\pm 1.27(0.05")$	$\pm 2.54(0.1")$	$\pm 1^\circ$

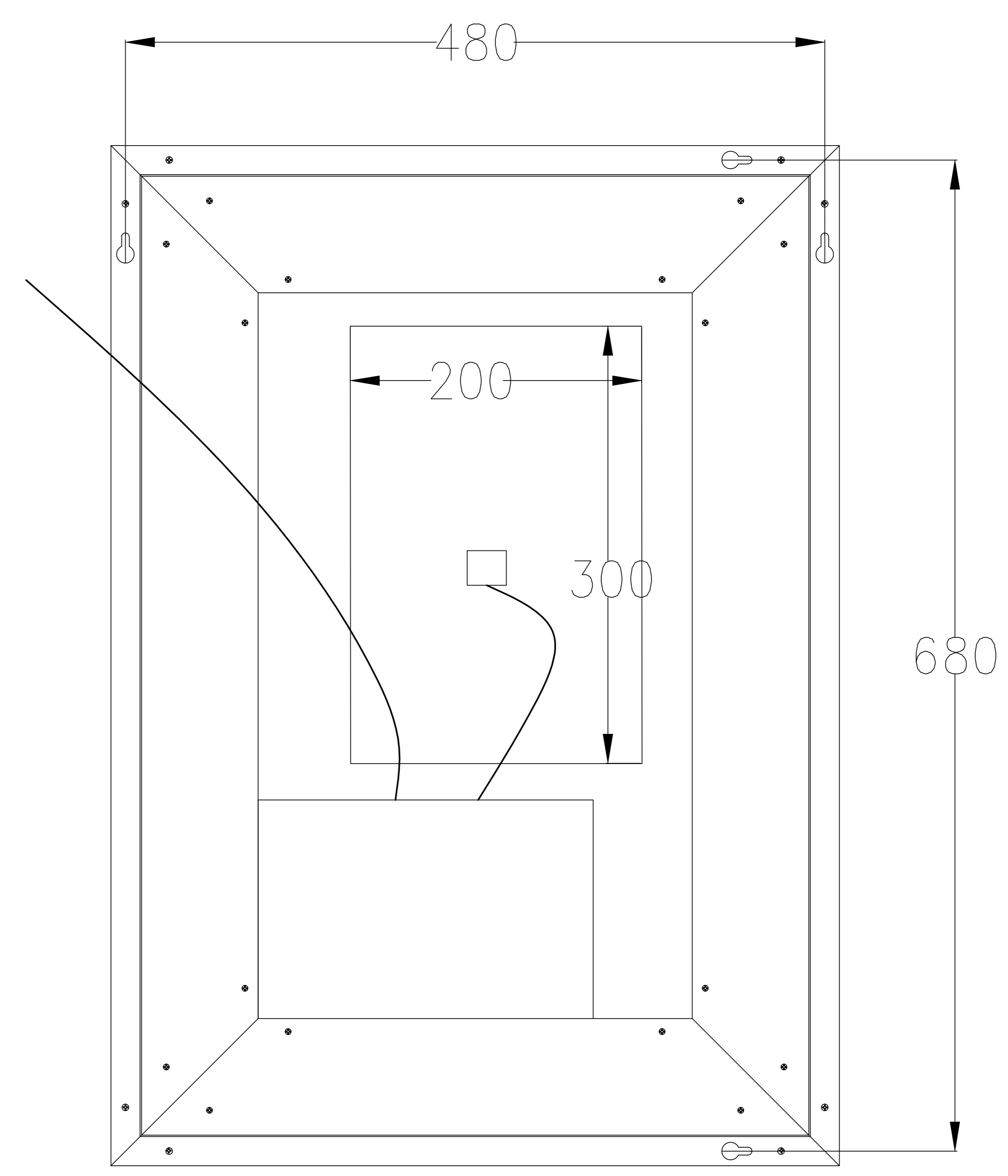
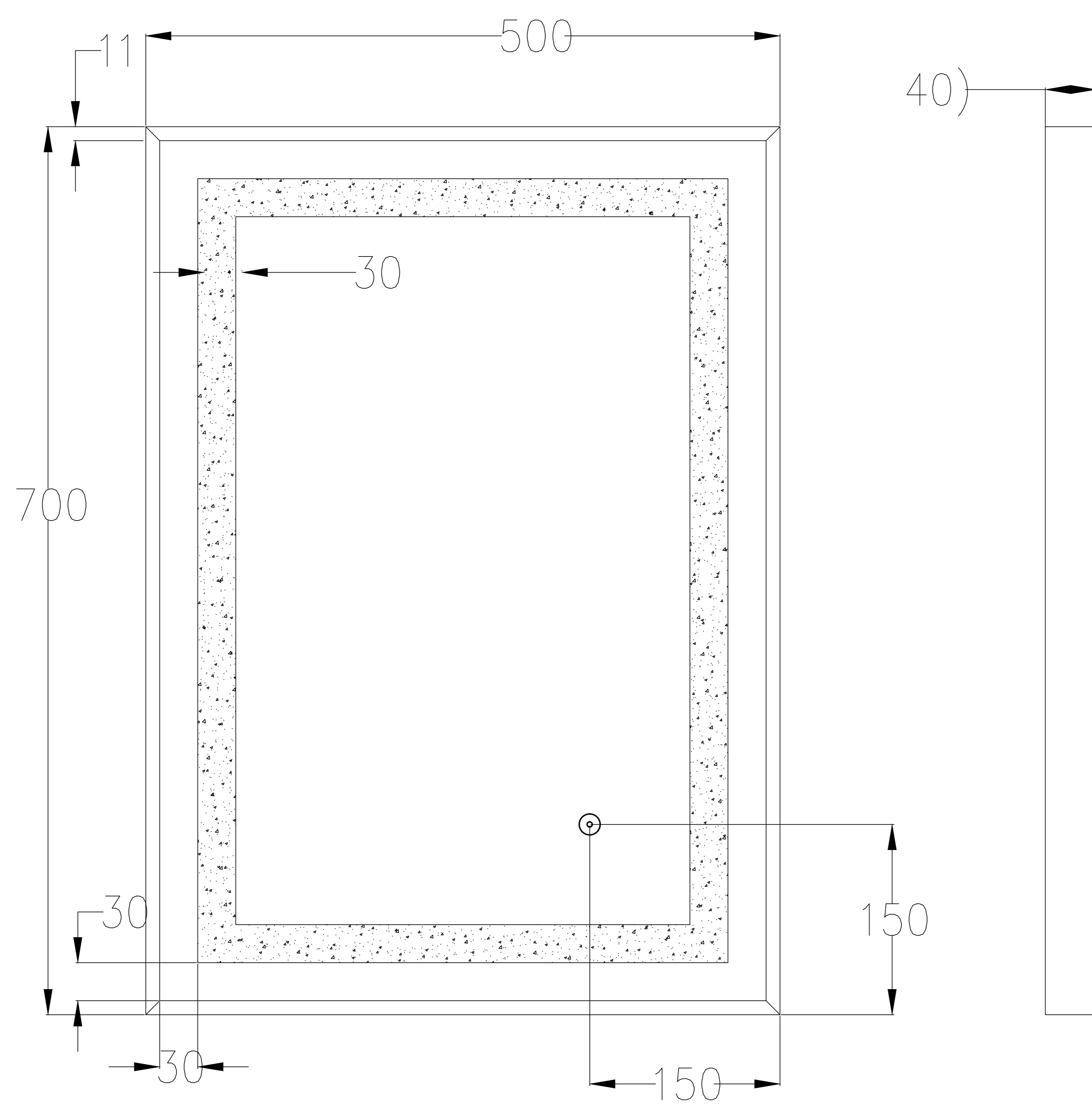

M1S334C0001EB (40. 1018)