

## DATASHEET

### Image



### General Information

Product:	41.0957
Description:	Imperia 3 Column Radiator 450 x 605mm
Product Type:	Radiator
Brand:	Eastbrook Company
Colour:	Matt Anthracite
Material:	Mild Steel
Height (mm):	450mm
Width (mm):	605mm
Net Weight (kg):	15.05kg
Product Range:	Imperia

### Product Specifications

Warranty:	5 Year(s)
Finish:	Matt
BTU $\Delta T50^{\circ}\text{C}$ :	1995
BTU $\Delta T60^{\circ}\text{C}$ :	2514
Watts $\Delta T50^{\circ}\text{C}$ :	585
Watts $\Delta T60^{\circ}\text{C}$ :	737

## Drawing

### Imperia 3 Column Horizontal 450 x 605mm. Painted Technical Drawing

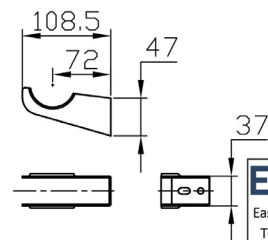
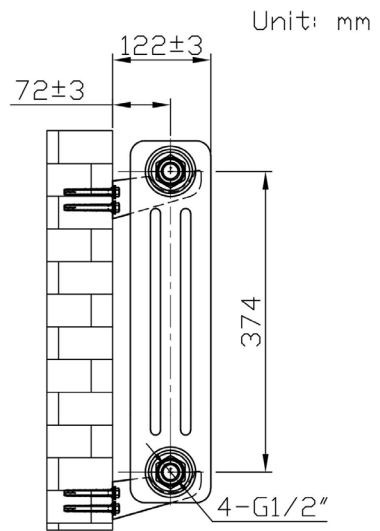
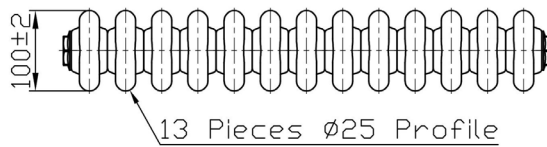
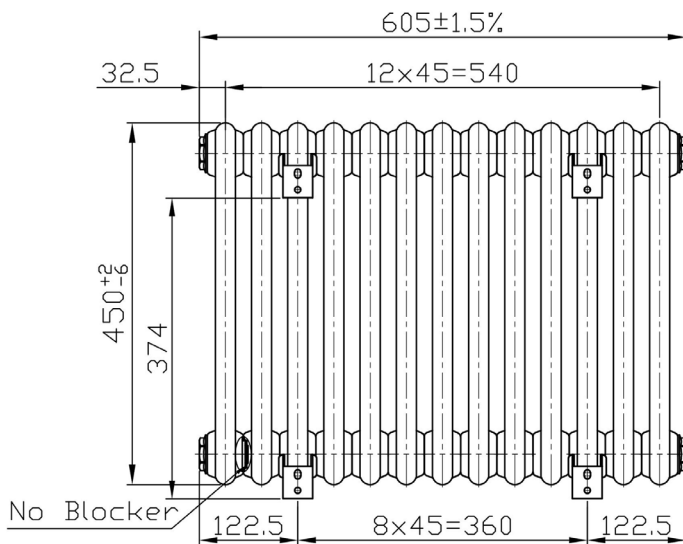

**Eastbrook**   
Eastbrook Road, Gloucester GL4 3DB  
Technical Helpline : 01452 317890  
Mon - Fri / 8am - 5pm  
Email : [technical@eastbrookco.com](mailto:technical@eastbrookco.com)