

Installation Manual

A122 Fill Valve + B228 Flush Valve + C529 Lever

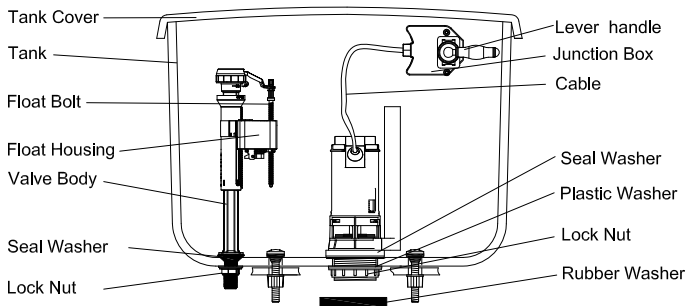

Diagram

Important: Before installation, please remove the old fittings and clean the tank. Please clean the water supply pipe first for newly installed one. Do not use plumber's putty to seal the fittings. Do not use chlorine(bleach) cleaners or related products.

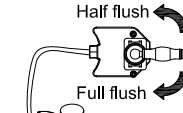

Full flush adjustment. The bigger the hole is, the less water flush.

Move the Slide up or down to adjust half flush. The higher the Slide is, the less water flush.

1. A122 Fill Valve:

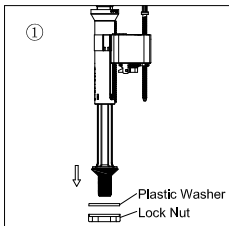

Disassemble the Lock Nut and Plastic Washer for valve installation.

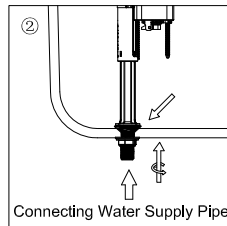

Position VALVE inside tank. Push down on the VALVE Shank while tightening Lock Nut.

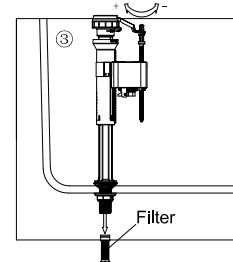

Adjusting water level by screwing Float Bolt, Take out of the Filter and clean it often.

2. B228 Flush Valve

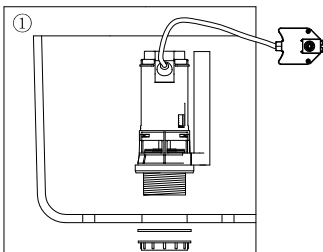

Disassemble Lock Nut for Valve installation. Position the VALVE inside the TANK. Push down on the Valve Body while tightening the Hexagon Nut from outside.

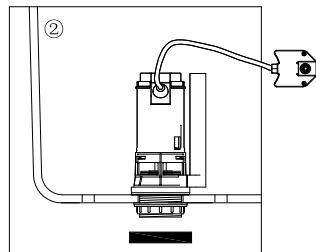

Nest the Rubber Washer in the Lock Nut.

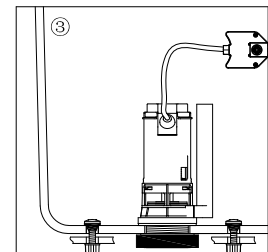

Nest the Tank To Bowl Washer in the Lock Nut and position the TANK on the Toilet Bowl properly. Disassemble the Tank to Bowl Bolts. Fix the Tank to Toilet Bowl with the Tank To Bowl Bolts tightly.

3. C529 Lever

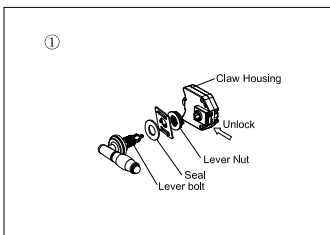

Unlock the Button Fixer of claw housing, take out the front lever, then loosen the lever nut.

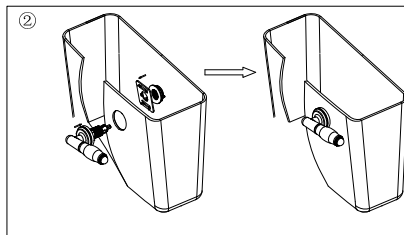

Install the lever in the front hole and fix the nut properly.

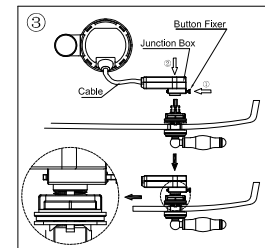

Make the Cable smooth, install the Lever on the Junction Box, and then close the Tank Lid. Fill the Tank with water and push the Full&Half Button to check whether the flushing is normal or not.

Note: Subject to the product if any difference.