

Wingrave Flat Panel 1800 x 510mm. Cover Technical Drawing

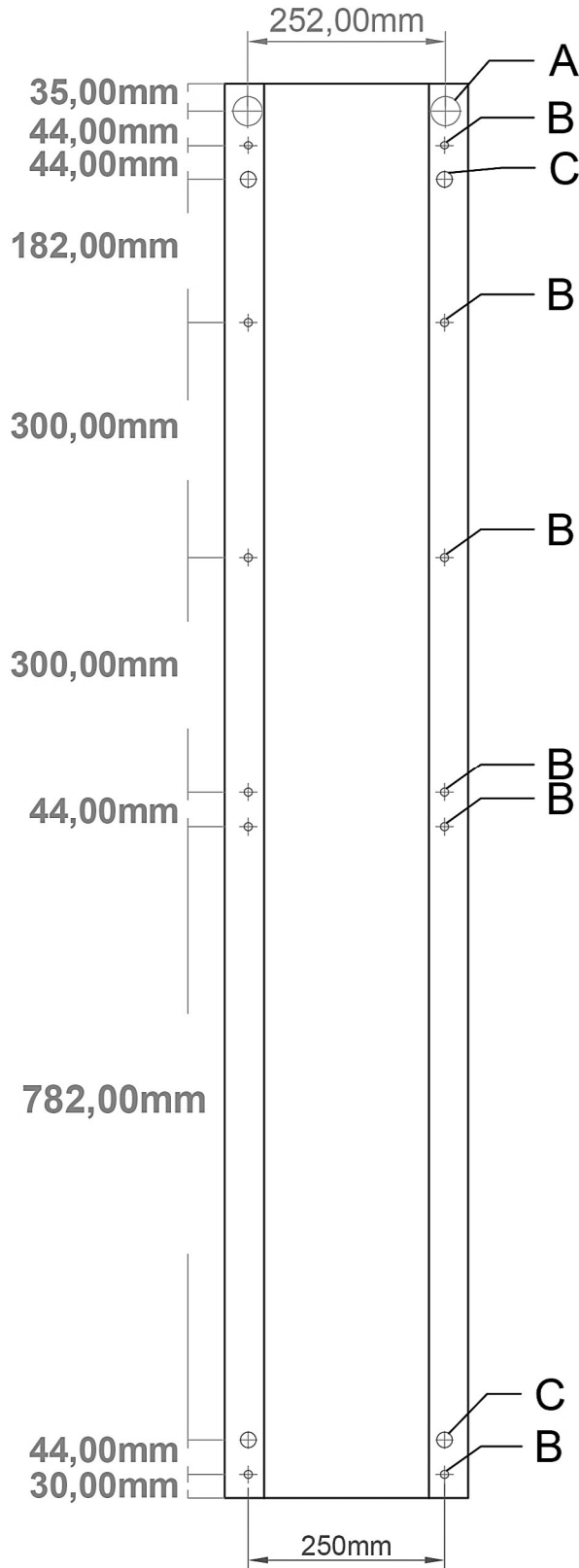

A DETAIL

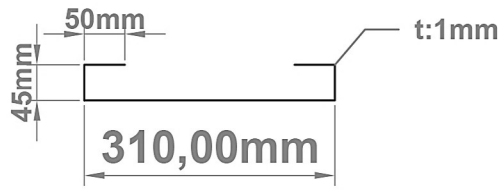
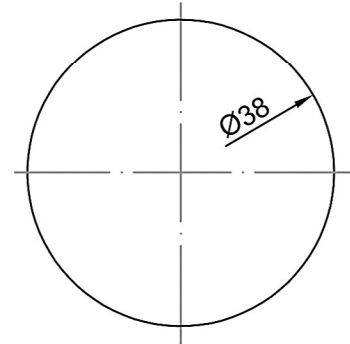

B DETAIL

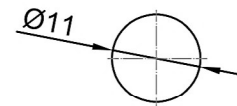

C DETAIL

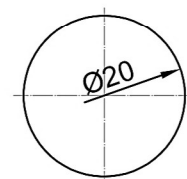

Wingrave Flat Panel 1800 x 310mm. Towel Rail Technical Drawing

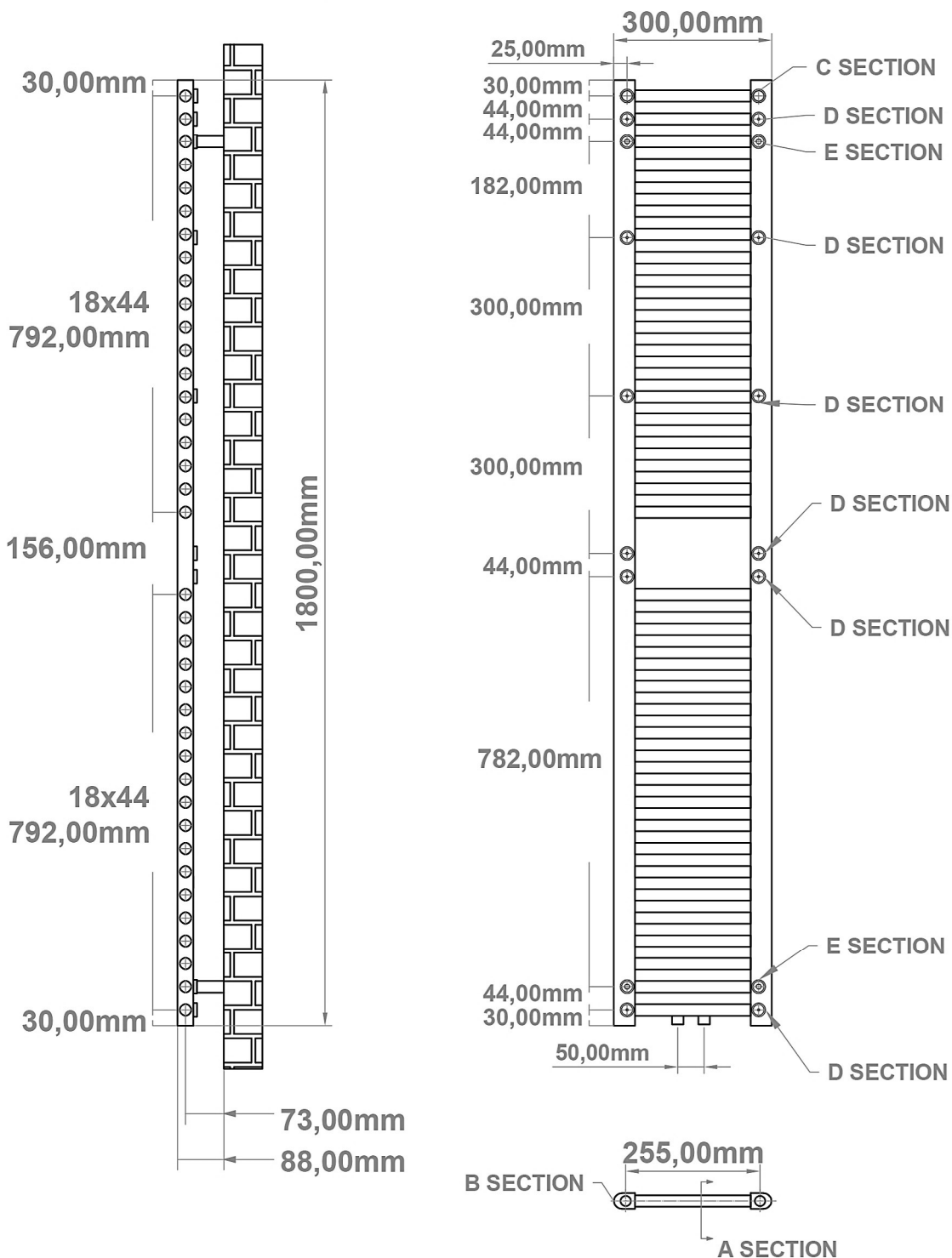

A SECTION

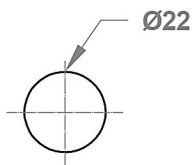

B SECTION

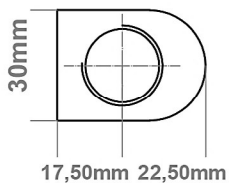

C SECTION

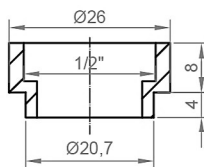

D SECTION

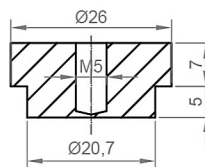

E SECTION

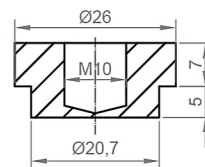

Eastbrook 

Eastbrook Road, Gloucester GL4 3DB

Technical Helpline : 01452 317890

Mon - Fri / 8am - 5pm

Email : technical@eastbrookco.com