



DRY ELEMENT ELECTRIC TOWEL RAIL USER MANUAL AND INSTALLATION INSTRUCTIONS FOR MODELS:

- 5055284967209 Biava Dry Element Towel Rail 700 x 500mm 250w CHROME – Class I IPX4 - 47.0001
- 5055284967216 Biava Dry Element Towel Rail 1100 x 500mm 400w CHROME - Class I IPX4 - 47.0002
- 5055284967223 Biava Dry Element Towel Rail 700 x 600mm 300w CHROME - Class I IPX4 - 47.0003
- 5055284967230 Biava Dry Element Towel Rail 1100 x 600mm 500w CHROME - Class I IPX4 - 47.0004
- 5055284971862 Biava Dry Element Towel Rail 700 x 500mm 250w WHITE – Class I IPX4 – 47.0005
- 5055284971879 Biava Dry Element Towel Rail 1100 x 500mm 400w WHITE - Class I IPX4 – 47.0006
- 5055284971886 Biava Dry Element Towel Rail 700 x 600mm 300w WHITE - Class I IPX4 – 47.0007
- 5055284971893 Biava Dry Element Towel Rail 1100 x 600mm 500w WHITE - Class I IPX4 – 47.0008
- 5055284971909 Biava Dry Element Towel Rail 700 x 500mm 250w MATT ANTHRACITE - Class I IPX4 – 47.0009
- 5055284971916 - Biava Dry Element Towel Rail 1100 x 500mm 400w MATT ANTHRACITE - Class I IPX4 – 47.0010
- 5055284971923 - Biava Dry Element Towel Rail 700 x 600mm 300w MATT ANTHRACITE - Class I IPX4 – 47.0011
- 5055284971930 - Biava Dry Element Towel Rail 1100 x 600mm 500w MATT ANTHRACITE - Class I IPX4 – 47.0012

WARNINGS

Keep this instruction sheet with care and read it carefully before using this device. You will so obtain the best performance with the highest safety.

- This appliance is intended only for drying textiles washed in water.
- This towel rail must be earthed.
- Before use, please check that the voltage of the network and that of the appliance are the same (pls. see the technical label).
- Always switch off the electricity supply at the mains during cleaning and maintenance.
- Electrical safety is guaranteed only if the element is connected to a suitably earthed electricity supply, according to the regulations in force.
- If the supply cord is damaged, it must be replaced by the manufacturer or similar qualified persons in order to avoid hazard. Failure to comply with the above may endanger the safety of the whole system.
- The rail will get very HOT so is NOT suitable for use in locations where this could cause a hazard (e.g. where infirmed persons or young children will be present unsupervised).
- The element must be permanently connected to a suitable electricity supply by way of the cable provided. This should be via a fused spur in accordance with the IEE Wiring Regulations.
- During the 1st and 2nd usage of this towel rail, there may be some vapour coming from the bottom or top of the vertical profiles for 10-15 minutes. This is completely normal and happens from the cleaning chemicals used.

IMPORTANT INFORMATION

This product must be installed by a competent person and in accordance with the current IEE Wiring Regulations. It may be necessary to notify your local authority building control department or to have the work carried out by a suitably qualified electrician.

The surface of the towel warmer may get very hot so it is not suitable for use in locations where this could be a hazard. In order to avoid a hazard for very young children this appliance should be installed so that the lowest heated rail is at least 600mm above floor level.

This appliance can be used by children aged from 8 years and above and persons with reduced physical, sensory or mental capabilities or lack of experience and knowledge if they have been given supervision or instruction concerning use of the appliance in a safe way and understand the hazards involved. Children shall not play with the appliance. Cleaning and user maintenance shall not be made by children without supervision.

The element contains a non-adjustable thermostate that will switch off and on as the towel warmer reaches temperature. The element also contains a non-replaceable thermal fuse safety device that will blow at 119 degrees centigrade if the thermostate were ever to fail.

PLEASE ENSURE THAT YOU WEAR ALL NECESSARY PERSONAL PROTECTIVE EQUIPMENT FOR YOUR SAFETY.

Please check that all components are present and that you are ENTIRELY happy with the size, design and finish BEFORE starting installation.

Pack Contents





1 x Electric Towel Rail
 4 x Bracket Base
 4 x Bracket Stem

4 x Bracket Front
 4 x Bracket Cover
 4 x Wall Plug

4 x Wall Screw
 4 x Washer
 4 x Bracket Screw
 4 x Mini Screw

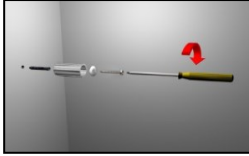
MOUNTING THE TOWEL RAIL ON THE WALL

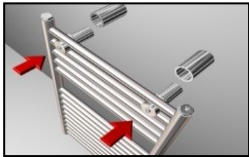
This appliance should be fixed on the wall as described below. Only the fixing kit provided with the appliance should be used. No adhesive shall be used since they are not considered to be a reliable fixing means.

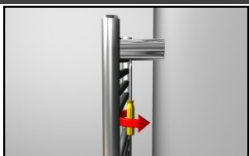
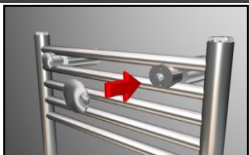
<p>STEP 1. Select your desired mounting position and check that the wall is sufficiently strong enough to hold the weight of the towel rail. Mark your preferred bracket positions on the wall and drill holes as necessary for the fixings that you are using. The Wall Plugs supplied are only suitable for solid walls. Please note: If the wall is other than a solid construction other means of fixings will be required.</p>	
<p>STEP 2. Screw the Bracket Base to the wall using the Wall Screws and Washers provided.</p>	
<p>STEP 3. Loosely fit the Bracket Stems to the towel rail with the Bracket Fronts and Bracket Screws.</p>	
<p>STEP 4. Align the Bracket Stems with the Bracket Bases and push the towel warmer back into position.</p>	
<p>STEP 5. Tighten the Bracket Screws with a screwdriver.</p>	
<p>STEP 6. Insert the Mini Screws into the Bracket Bases and tighten with a screwdriver to lock bracket into position.</p>	
<p>STEP 7. Push the Cover Caps into position on the Bracket Fronts.</p>	

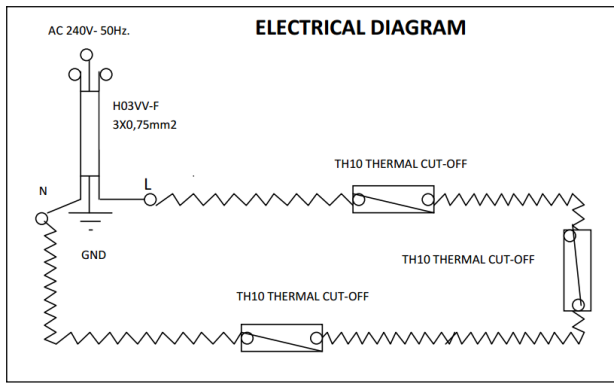

ELECTRICAL SPECIFICATIONS

- MODEL : 5055284967209 Biava Dry Element Towel Rail 700 x 500mm CHROME – **47.0001**
V=AC240V-50Hz. P=**250W** I=1.04A
- MODEL : 5055284967216 Biava Dry Element Towel Rail 1100 x 500mm CHROME – **47.0002**
V=AC240V-50Hz. P=**400W** I=1.67A
- MODEL : 5055284967223 Biava Dry Element Towel Rail 700 x 600mm CHROME - **47.0003**
V=AC240V-50Hz. P=**300W** I=1.25A
- MODEL : 5055284967230 Biava Dry Element Towel Rail 1100 x 600mm CHROME – **47.0004**
V=AC240V-50Hz. P=**500W** I=2.08A
- MODEL : 5055284971862 Biava Dry Element Towel Rail 700 x 500mm WHITE – **47.0005**
V=AC240V-50Hz. P=**250W** I=1.04A
- MODEL : 5055284971879 Biava Dry Element Towel Rail 1100 x 500mm WHITE – **47.0006**
V=AC240V-50Hz. P=**400W** I=1.67A
- MODEL : 5055284971886 Biava Dry Element Towel Rail 700 x 600mm WHITE – **47.0007**
V=AC240V-50Hz. P=**300W** I=1.25A
- MODEL : 5055284971893 Biava Dry Element Towel Rail 1100 x 600mm WHITE – **47.0008**
V=AC240V-50Hz. P=**500W** I=2.08A
- MODEL : 5055284971909 Biava Dry Element Towel Rail 700 x 500mm MATT ANTHRACITE – **47.0009**
V=AC240V-50Hz. P=**250W** I=1.04A
- MODEL : 5055284971916 - Biava Dry Element Towel Rail 1100 x 500mm MATT ANTHRACITE – **47.0010**
V=AC240V-50Hz. P=**400W** I=1.67A
- MODEL : 5055284971923 - Biava Dry Element Towel Rail 700 x 600mm MATT ANTHRACITE – **47.0011**
V=AC240V-50Hz. P=**300W** I=1.25A
- MODEL : 5055284971930 - Biava Dry Element Towel Rail 1100 x 600mm MATT ANTHRACITE – **47.0012**
V=AC240V-50Hz. P=**500W** I=2.08A

ELECTRICAL CONNECTION

Always switch off the electricity supply at the mains during installation. The electrical connection must be carried out by a competent person and in accordance with the current IEE Wiring Regulations. It may be necessary to notify your local authority building control department or to have the work carried out by a suitably qualified electrician.

Connecting the power supply cable to the mains (AC240V – 50Hz.)

GREEN & YELLOW = EARTH

BLUE = NEUTRAL

BROWN = LIVE

CARE AND MAINTENANCE

- Regular cleaning with a soft cloth will keep the surfaces of your towel warmer looking new.
- Soapy water can be used to remove stubborn stains and then buff dry with a soft cloth.
- Do not use abrasive or chemical cleaners to clean your towel warmer as these will damage the surface finish over time.

DISPOSAL



This appliance is NOT an ordinary domestic refuse. It must be disposed of through the appropriate recollection centres to be recycled. In case of replacement it can be sent back to your distributor.

This handling of the product's end of life will allow us to preserve our environment and curb the consumption of natural resources. This symbol applied on the product, indicates the obligation to consign it to a special recollection centre to be disposed of in accordance with European Directive WEEE 2002/96/EC guideline. The manufacturer reserves the right to modify the product without previous notice for technical or construction improvements.

This towel rail is warranted for a period of 2 years against manufacturing defects only. Eastbrook Company warranty covers replacement of product or refund only. The Eastbrook Company warranty does not cover, offer or imply cover for any consequential losses whatsoever. Claims for consequential losses will not be entertained.

TECHNICAL SUPPORT LINE 01452 317890