

Code No.: 33.0046

Dimensions: 1500x745x580 mm

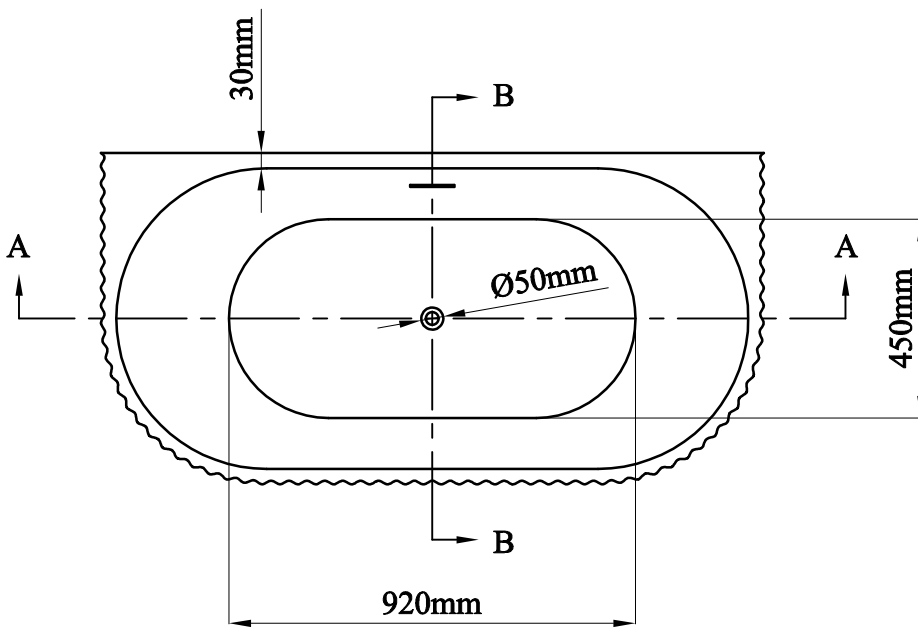
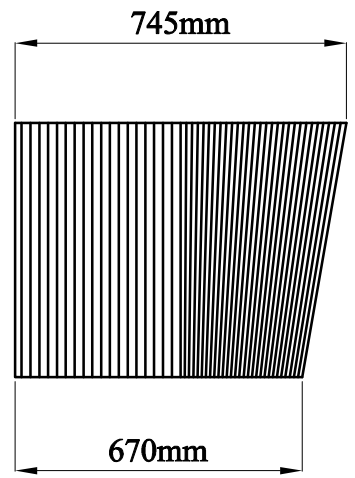
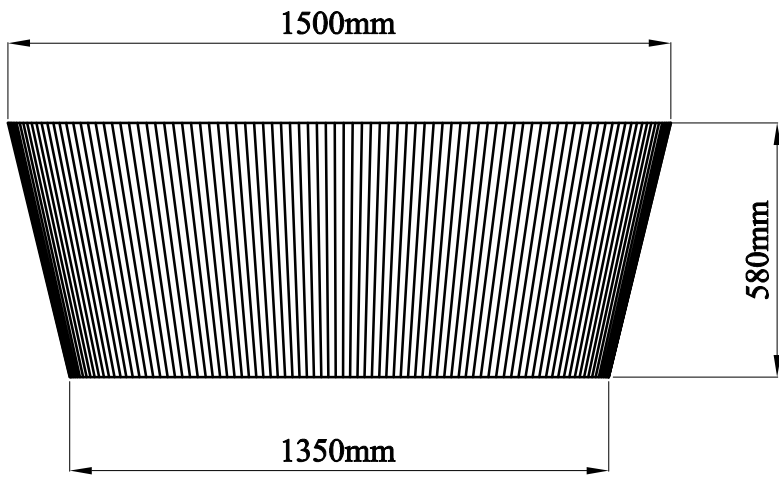

SECTION A-A

SECTION B-B

