

Code No.: 33.0047

Dimensions: 1500x750x580 mm

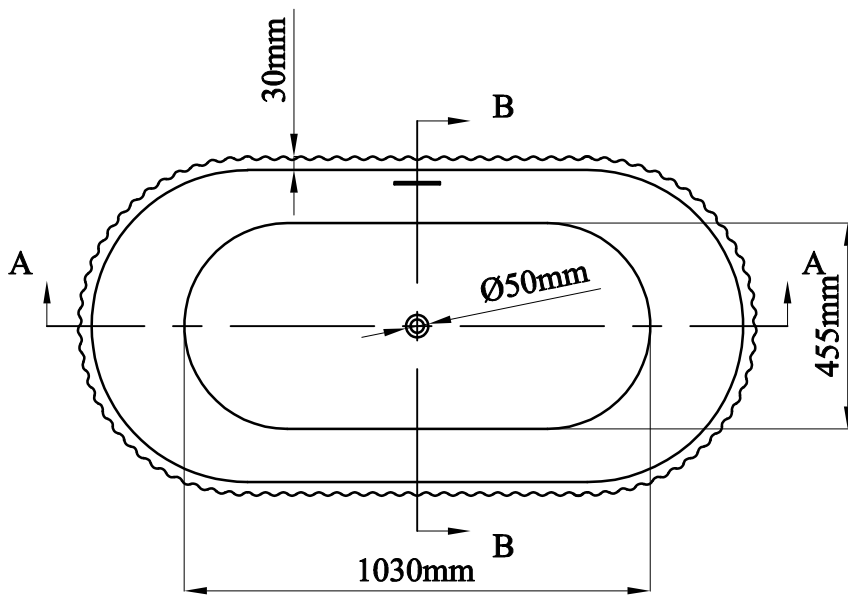
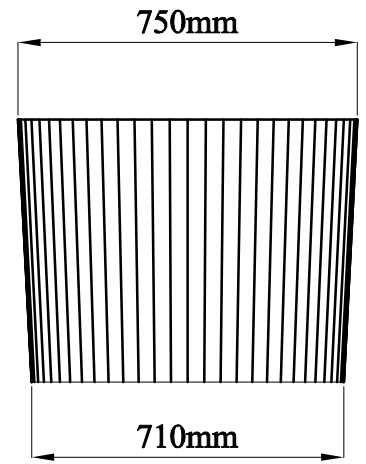
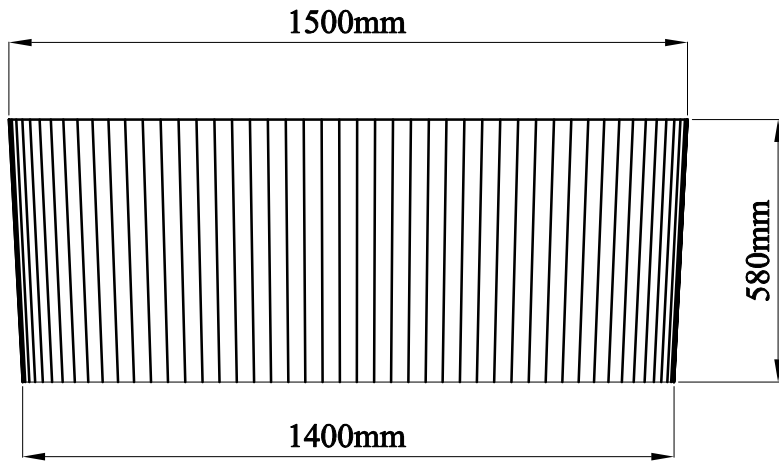

SECTION A-A

SECTION B-B

