

Code No.: 34.0048

Dimensions: 1650x750x580 mm

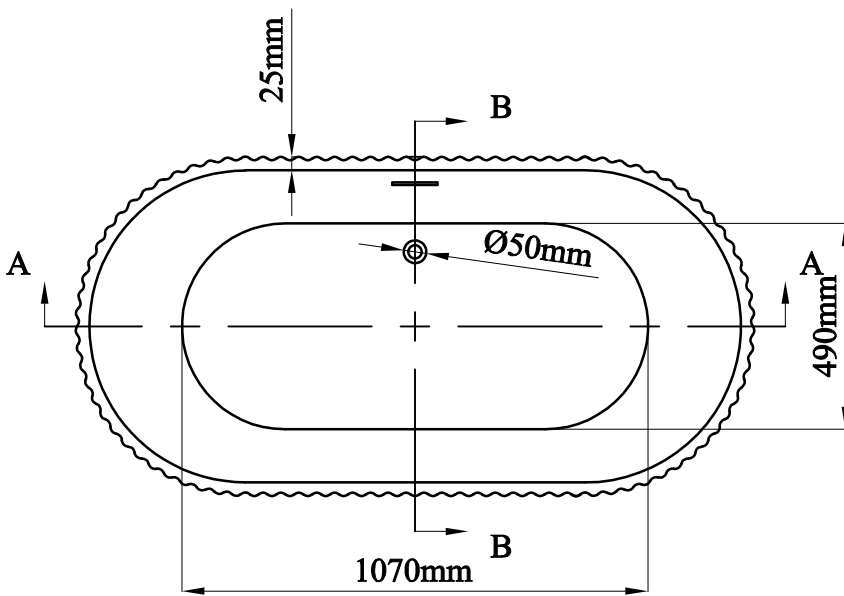
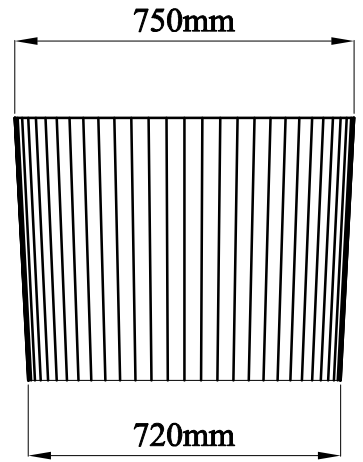
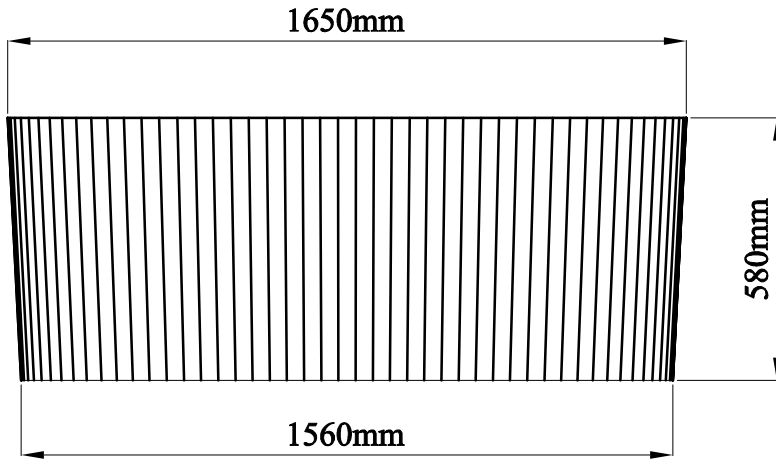

SECTION A-A

SECTION B-B

