

Code No.: 33.0049

Dimensions: 1495x740x580 mm

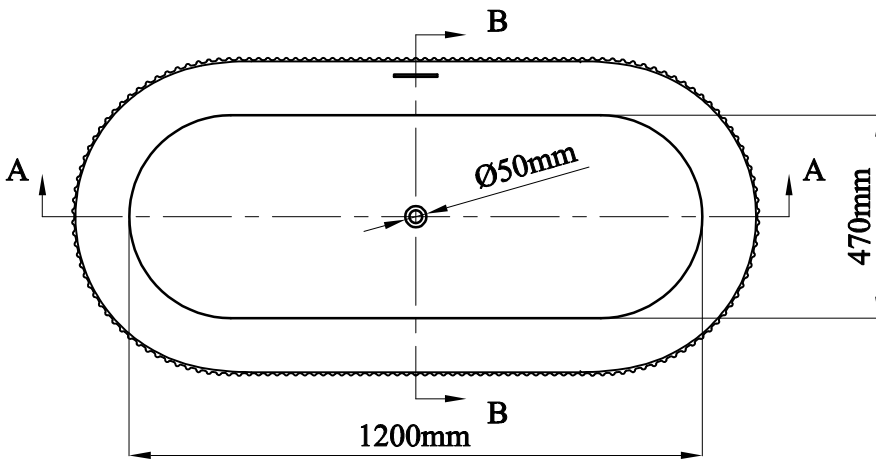
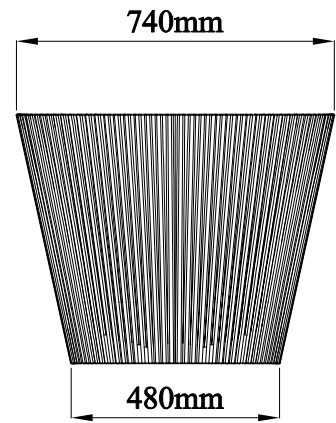
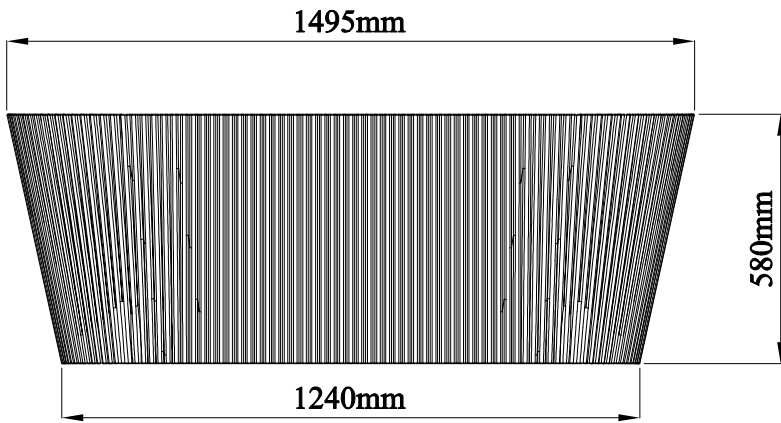

SECTION A-A

SECTION B-B

