

Code No.: 33.0051

Dimensions: 1595x740x580 mm

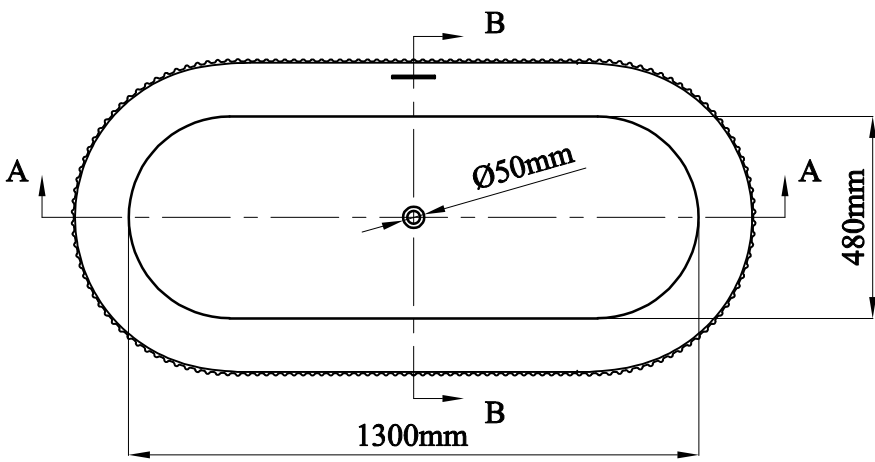
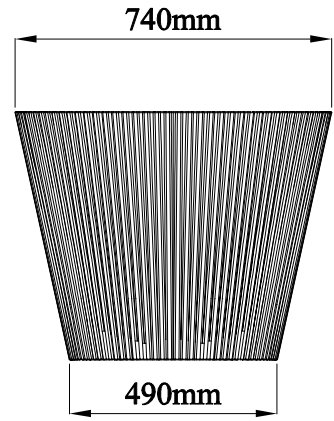
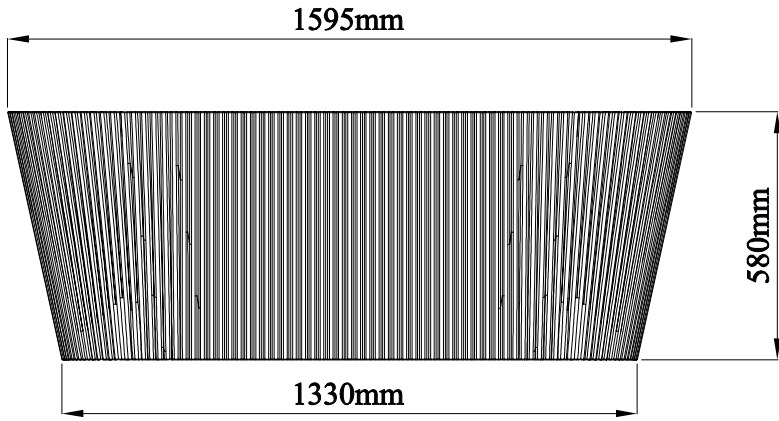

SECTION A-A

SECTION B-B

