

Code No.: 33.0052

Dimensions: 1650x740x600 mm

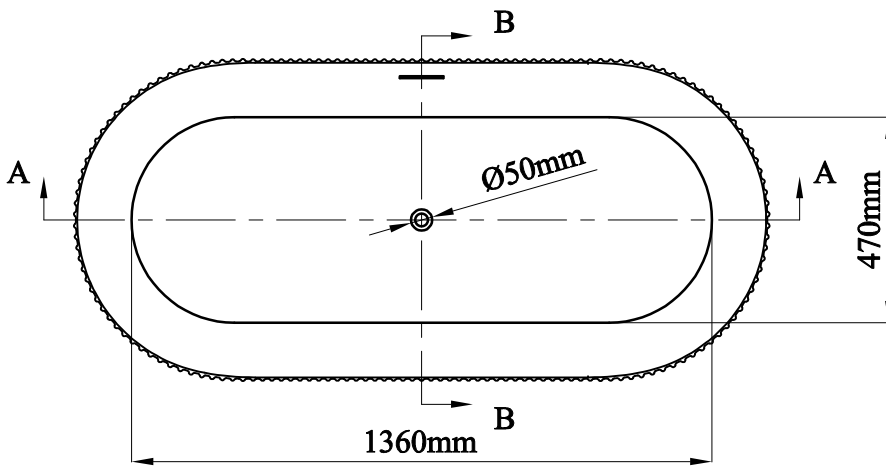
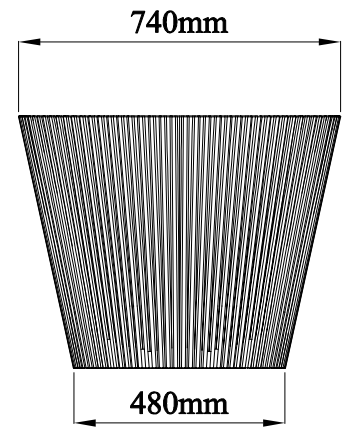
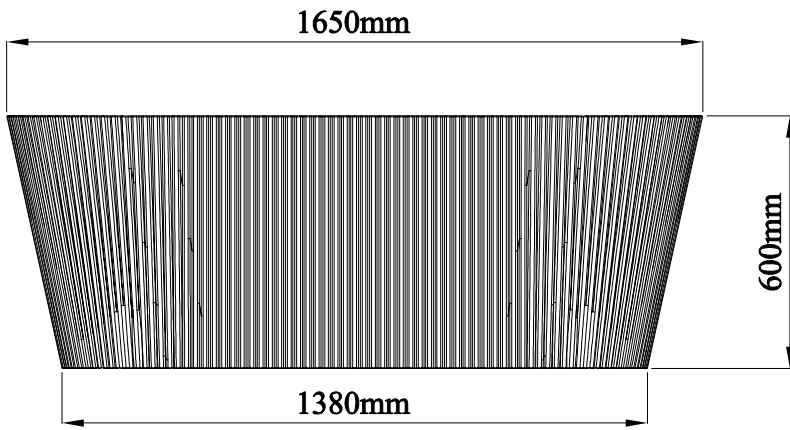

SECTION A-A

SECTION B-B

