

Sanitary fixing systems

Installation instruction

- toilet fixing set
- Usage
- For fixing of: standing toilets
- content

1	2×Wallplugs S10×50
2	2×Screw 6×80
3	2×Plastic washers
4	2×White caps

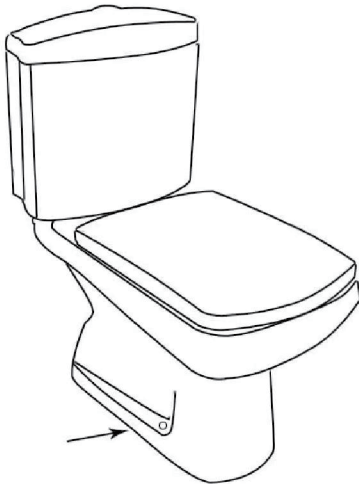
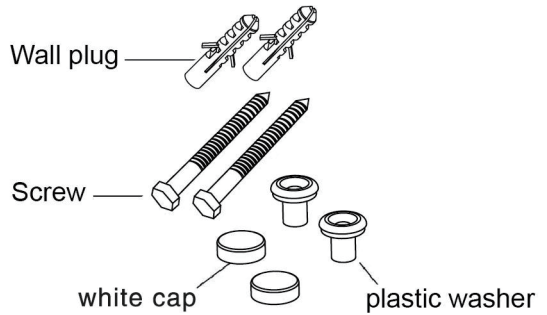

Toilet

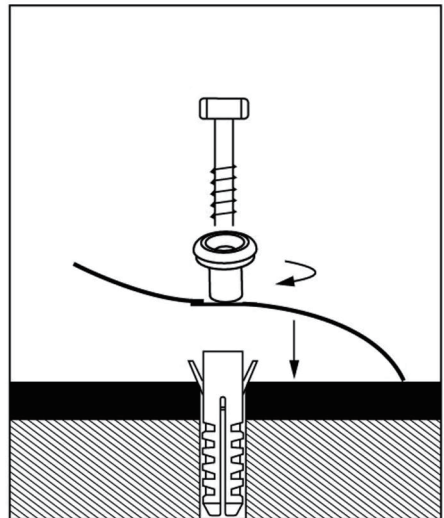

Installation

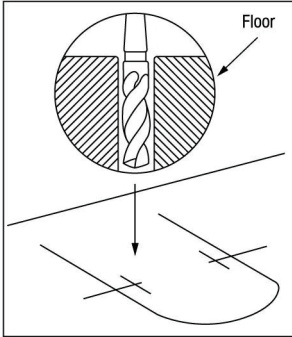

Drill dia 10mm, approx 40mm from the edge of the pan.
Minimum drill hole depth 60mm

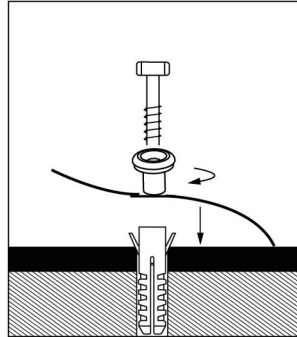

Tighten fixing bracket

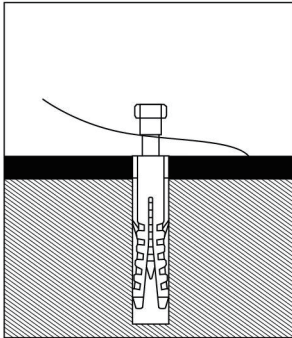

Put on the new toilet

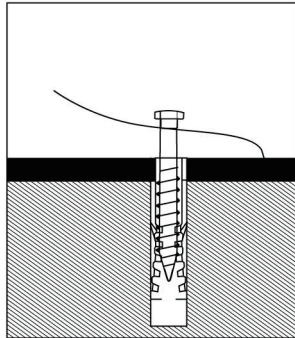

Tighten the screws

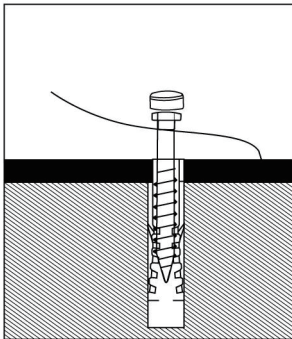

Put on the white caps