

# INSTALLATION MANUAL

## Vallant Walk-in Panel C

Eastbrook Code	Adjustment	Eastbrook Code	Adjustment
58.363	300	58.364	700
58.365	760	58.366	800
58.367	900	58.368	1000

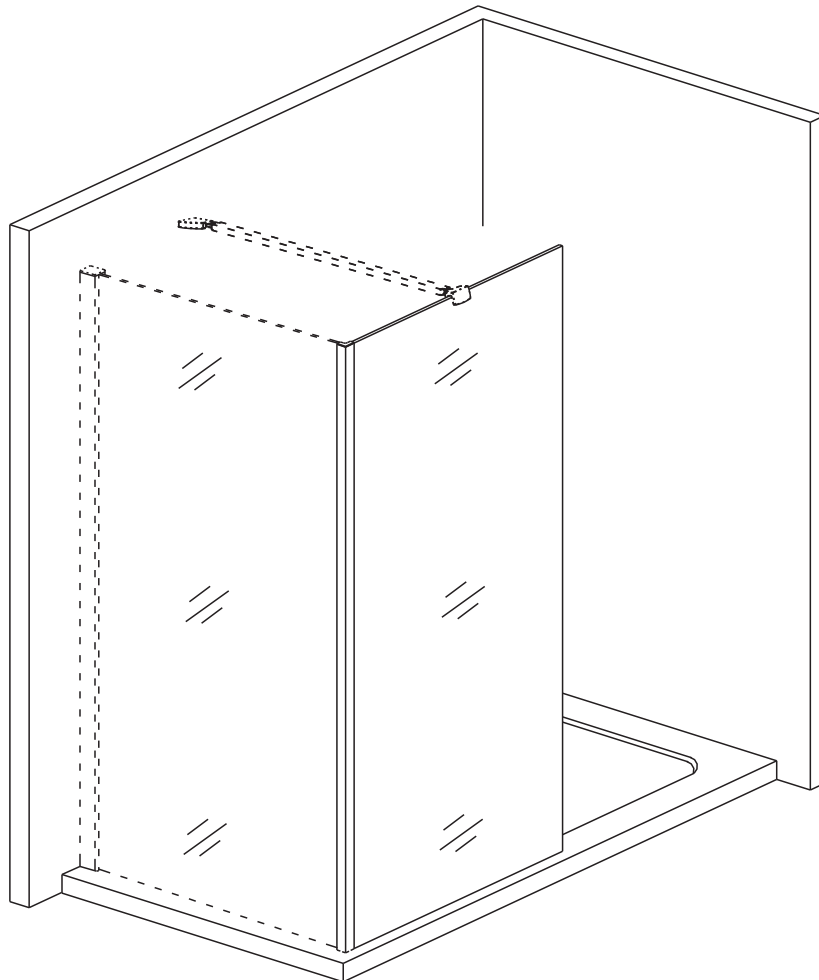

This product should only be fitted by a fully qualified installer.  
 This product must be unpacked and checked for quality prior to installation.  
 Any missing parts or damage must be reported to your supplier within 10 days  
 of purchase and before installation.  
 No claims can be enforced outside of the terms.



# TOOLS REQUIRED

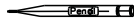

Pencil

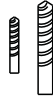

(Ø6.3.2) Drill bit

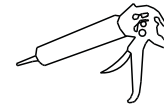

Silicone gun

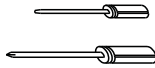

Flat and cross  
screwdriver

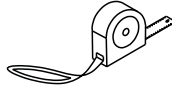

Tape measure



Spirit level

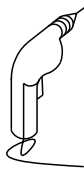

Electric drill

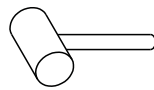

Rubber hammer

# LIST OF SPARE PARTS

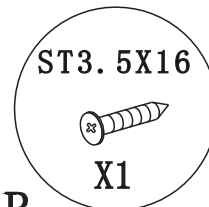
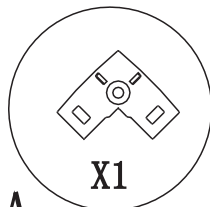

Please make the following checks before connecting the installation:

- The product supplied is the required size and the adjustment is compatible with the site situation.
- Check all component parts are present, see packing list and product schematic diagram for reference.
- Make sure you have all the required tools.

PRODUCT SCHEMATIC DIAGRAM

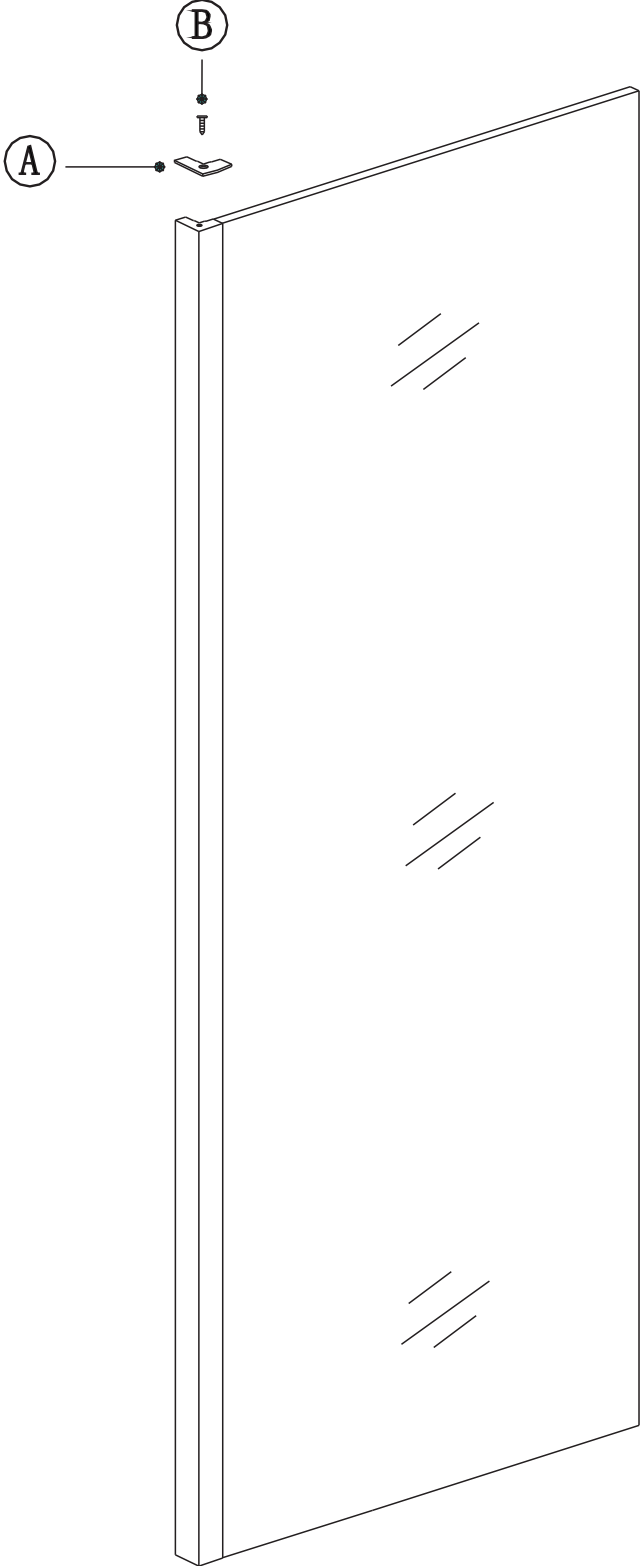

1

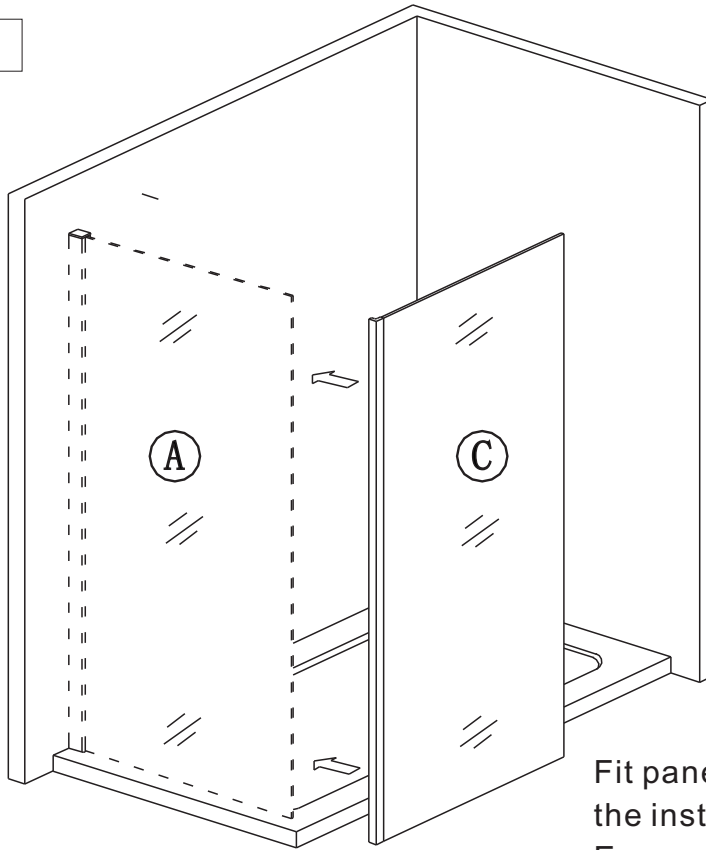

Fit panel (A) (not supplied) to wall following the instructions provided with panel. Ensure enough tolerance is left to fit panel (C).

2

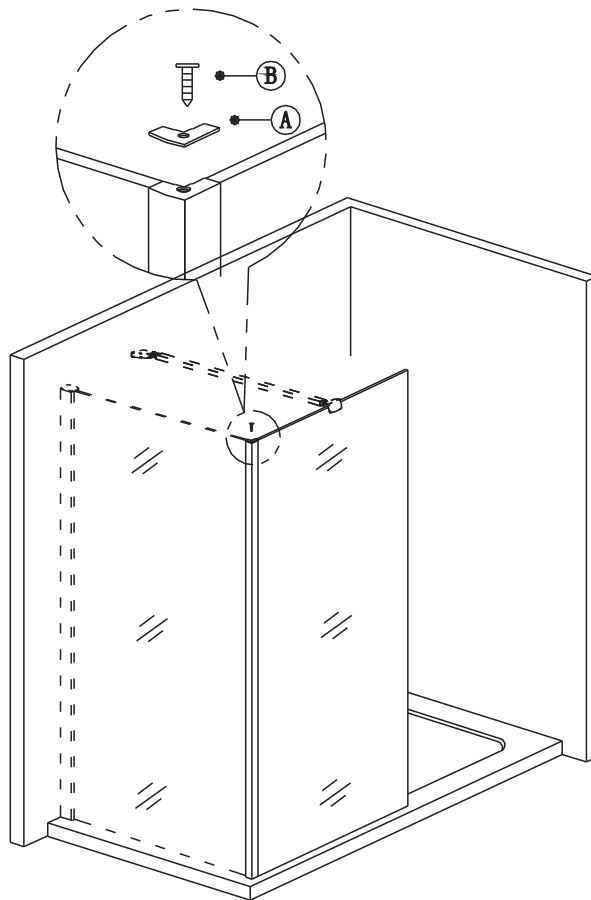

Slide corner profile onto end of panel (A) and secure in place with fixings (A) and (B). Fit wall support bar (not supplied) following the instructions provided.

(3)

3

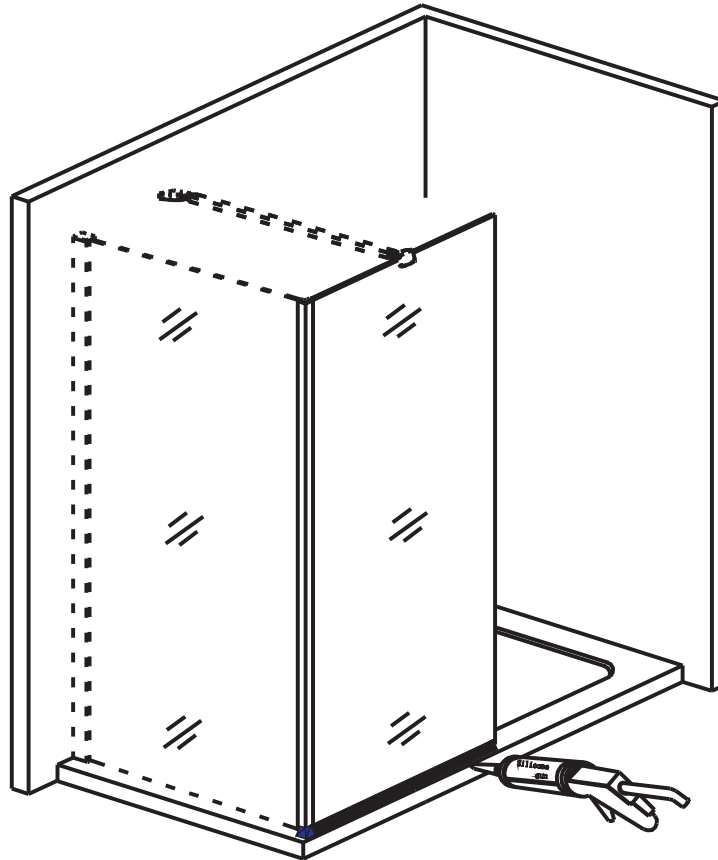

Silicone as illustrated ensuring silicone sealant is on the outside only.

---

### **Cleaning & Maintenance**

Don't clean the shower enclosure with irritant detergent such as alcohol, bleach or other chemical cleaners.

Only clean with warm soapy water .

Helpline:01452 317890

(4)