

## DATASHEET

### Image



### General Information

Product:	41.0741
Description:	Type B Element Wi-Fi 150W
Website Link:	<a href="#">(Click Here)</a>
Product Type:	Heating Element
Brand:	Eastbrook Company
Colour:	Matt Black
Length (mm):	45mm
Net Weight (kg):	0.26kg
Product Range:	Type B Wi-Fi Element

### Product Specifications

Warranty:	2 Year(s)
Watts:	150

**Drawing**

**Type B Wi-Fi Element  
 Technical Drawing**

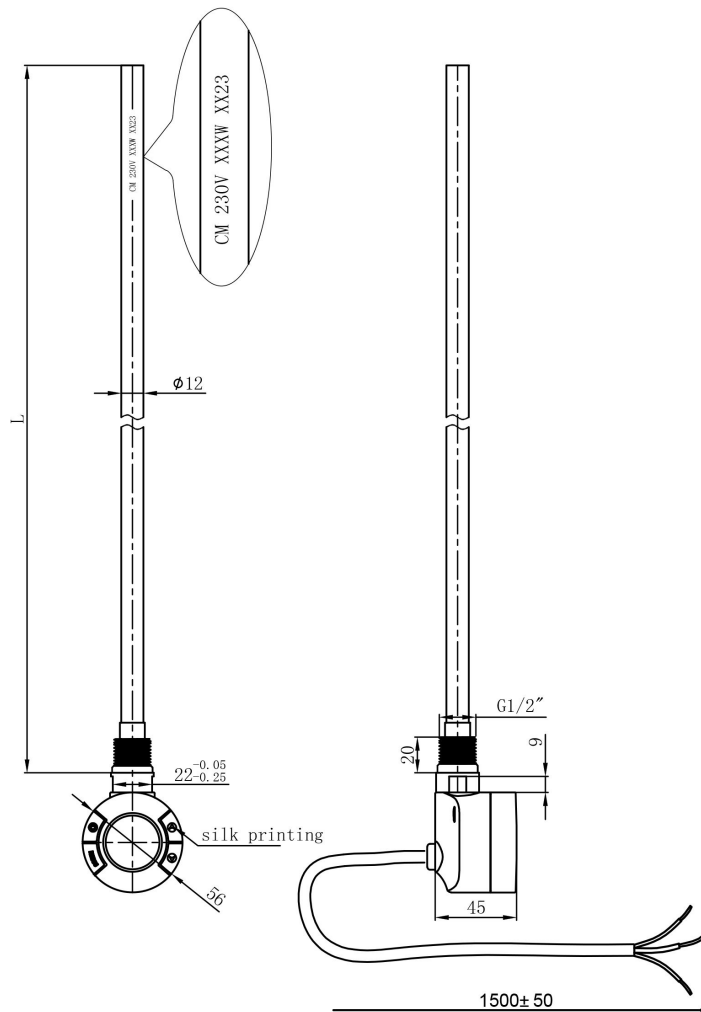

Power	Resistance Length (L)
150W	245mm.
300W	315mm.
600W	545mm.
900W	755mm.

\* Tolerance +/- 5mm.

**Notes :**

1. Cable colour for gloss white and chrome element is white.
2. Cable colour for matt anthracite and matt black element is black.
3. Cable length for all Type B Wi-Fi elements is 1.5 metre (+/- 5 cm).
4. IP rating is IPX4.

**Eastbrook**   
 Eastbrook Road, Gloucester GL4 3DB  
 Technical Helpline : 01452 317890  
 Mon - Fri / 8am - 5pm  
 Email : technical@eastbrookco.com