

DATASHEET

Image



General Information

Product:	8.330
Description:	Type D Element with Boost 600W
Website Link:	(Click Here)
Product Type:	Heating Element
Brand:	Eastbrook Company
Colour:	Matt Anthracite
Material:	
Net Weight (kg):	0.465kg
Product Range:	Type D with Boost Element

Product Specifications

Warranty:	1 Year(s)
Orientation:	
Watts:	600
Valve Types:	

Drawing

**Type D Element with Boost
 Technical Drawing**

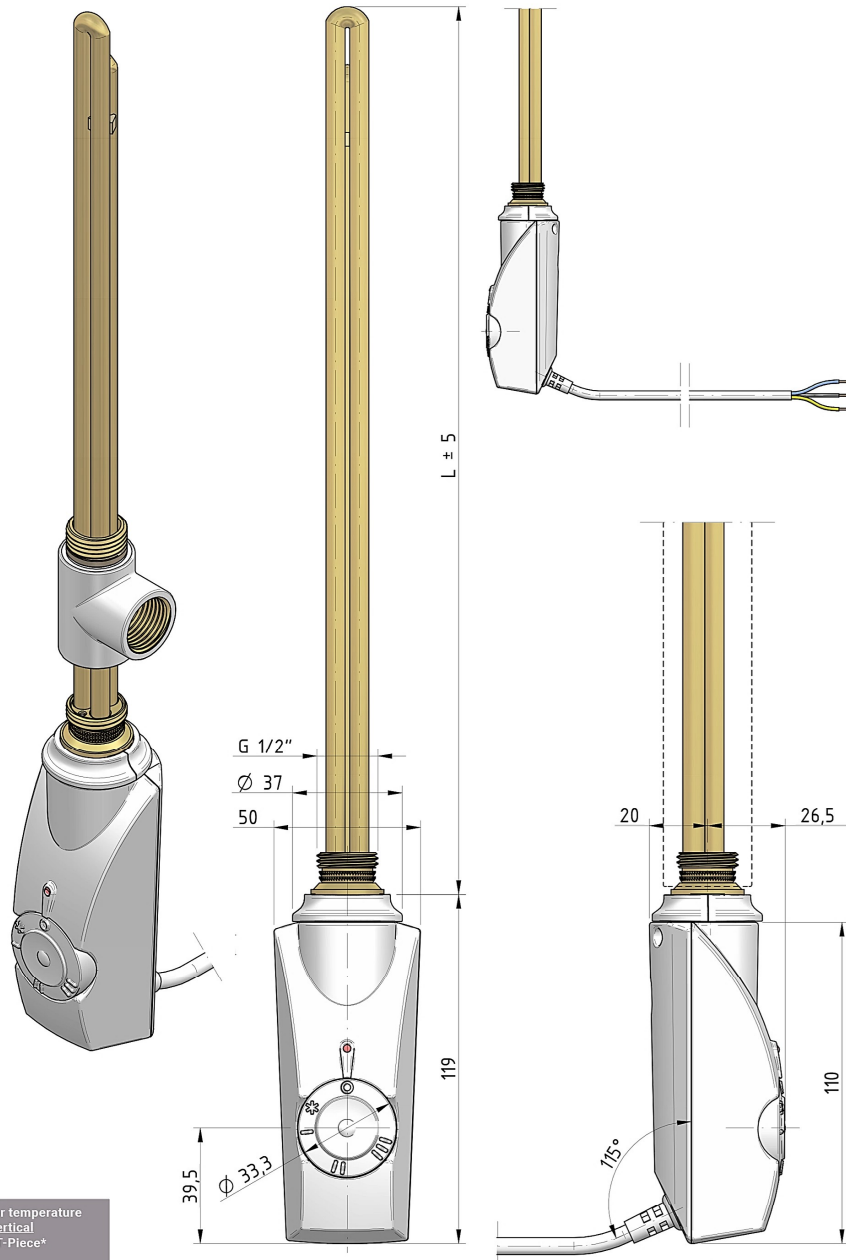

Including radiator temperature thermostat for vertical installation and T-Piece*

*Chrome, Matt Anthracite & Matt Black elements come with Chrome T-Piece.
 *Gloss White & Matt White elements both come with white T-Piece.

Power	Length
300W	340
600W	390
900W	440

Eastbrook 
 Eastbrook Road, Gloucester GL4 3DB
 Technical Helpline : 01452 317890
 Mon - Fri / 8am - 5pm
 Email : technical@eastbrookco.com