

## DATASHEET

### Image



### General Information

Product:	25.7003
Description:	Keynsham Type 22 Panel Radiator 600 x 800 with Flat Designer Cover
Website Link:	<a href="#">(Click Here)</a>
Product Type:	Radiator
Brand:	Eastbrook Company
Colour:	Gloss White
Material:	Mild Steel
Height (mm):	600mm
Width (mm):	800mm
Net Weight (kg):	4kg
Product Range:	Keynsham Compact Panel

### Product Specifications

Warranty:	10 Year(s)
BTU $\Delta T50^{\circ}\text{C}$ :	4506
BTU $\Delta T60^{\circ}\text{C}$ :	5671
Watts $\Delta T50^{\circ}\text{C}$ :	1320
Watts $\Delta T60^{\circ}\text{C}$ :	1663

**Drawing**

**Keynsham Flat Designer Cover - Type 22**  
**Technical Drawing**

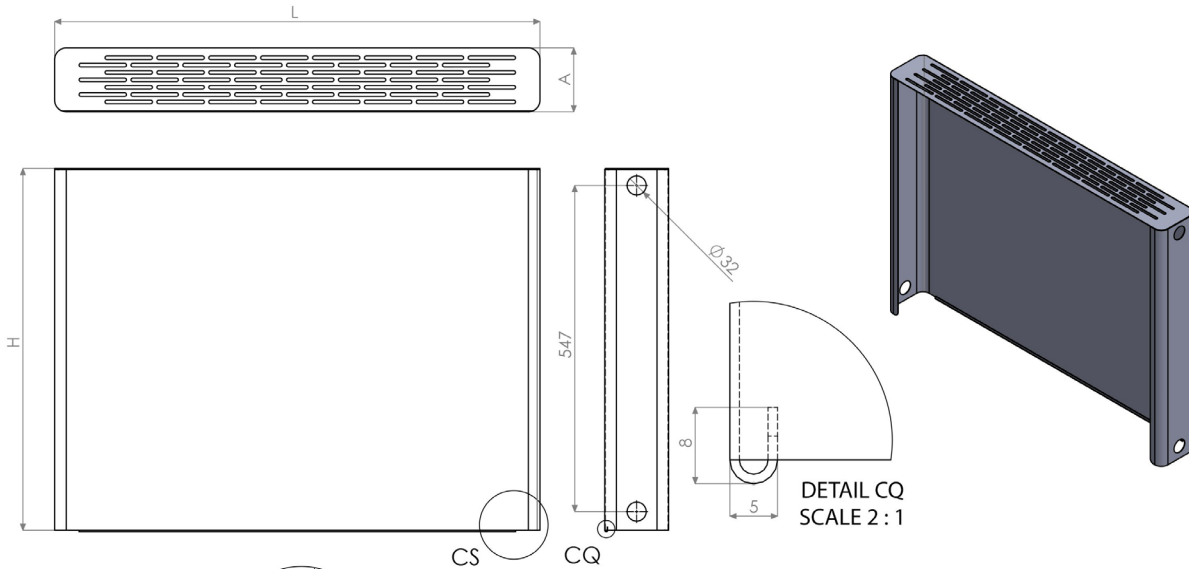

DETAIL CQ  
 SCALE 2 : 1

DETAIL CS  
 SCALE 1 : 4

	L	H	A
600x400	414	606.6	107.1
600x500	514		
600x600	614		
600x800	814		
600x1000	1014		
600x1200	1214		

**Eastbrook**   
 Eastbrook Road, Gloucester GL4 3DB  
 Technical Helpline : 01452 317890  
 Mon - Fri / 8am - 5pm  
 Email : technical@eastbrookco.com