

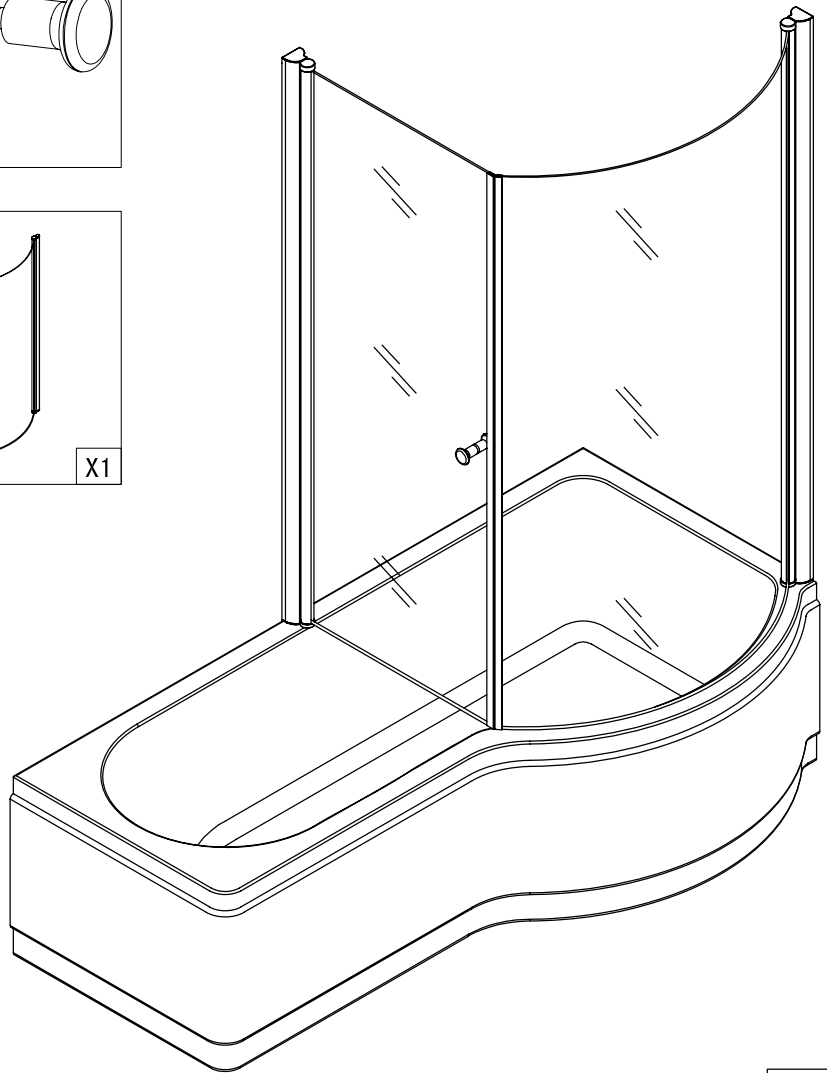

manual

Eastbrook 

Beaufort Screen Type 1-2
Pivot door

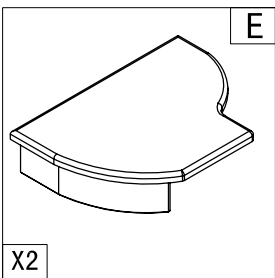
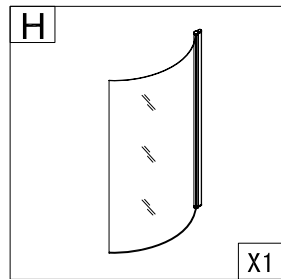
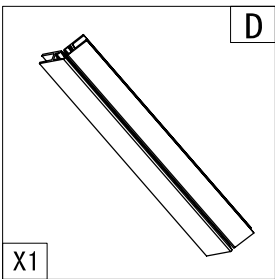
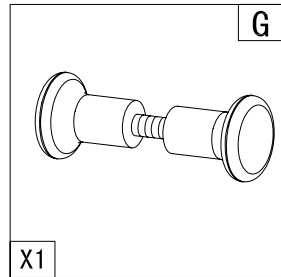
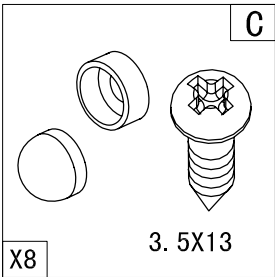
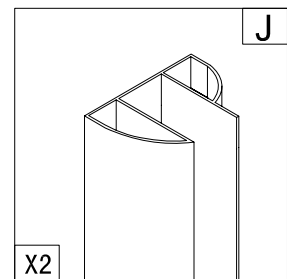
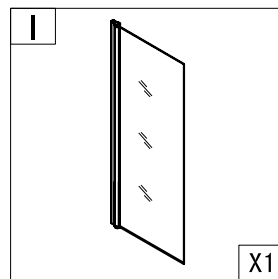
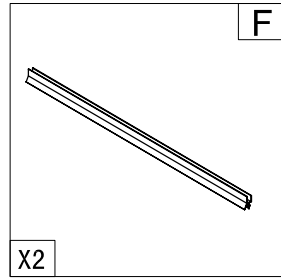
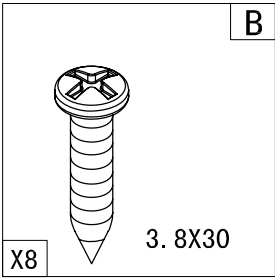
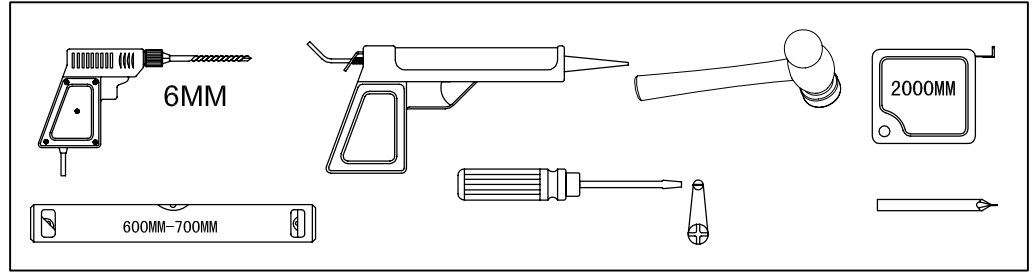
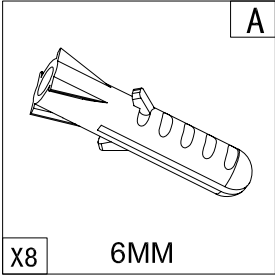

R/H

600MM-700MM

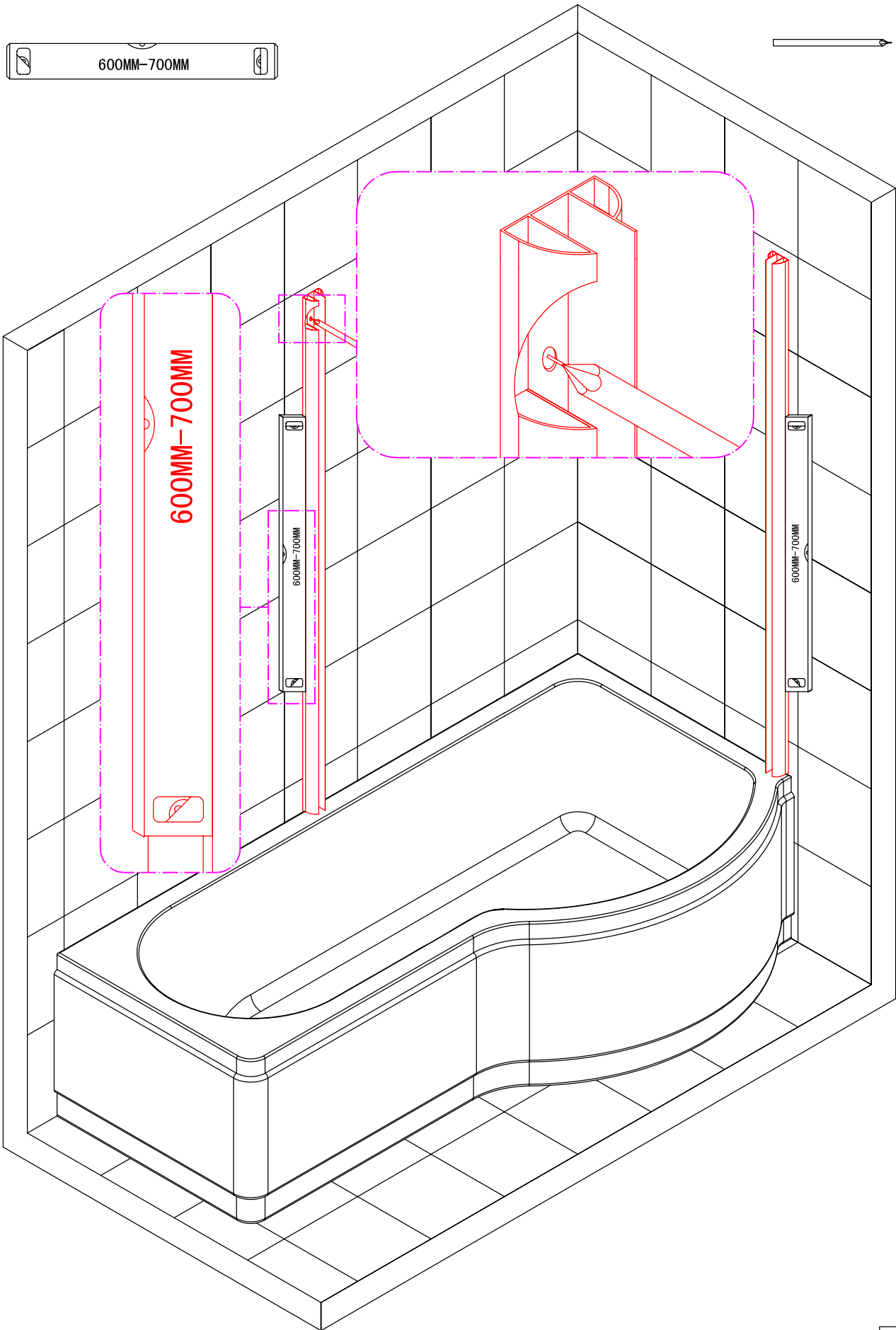
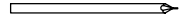

Dry fit required for best position to connect wall profile!

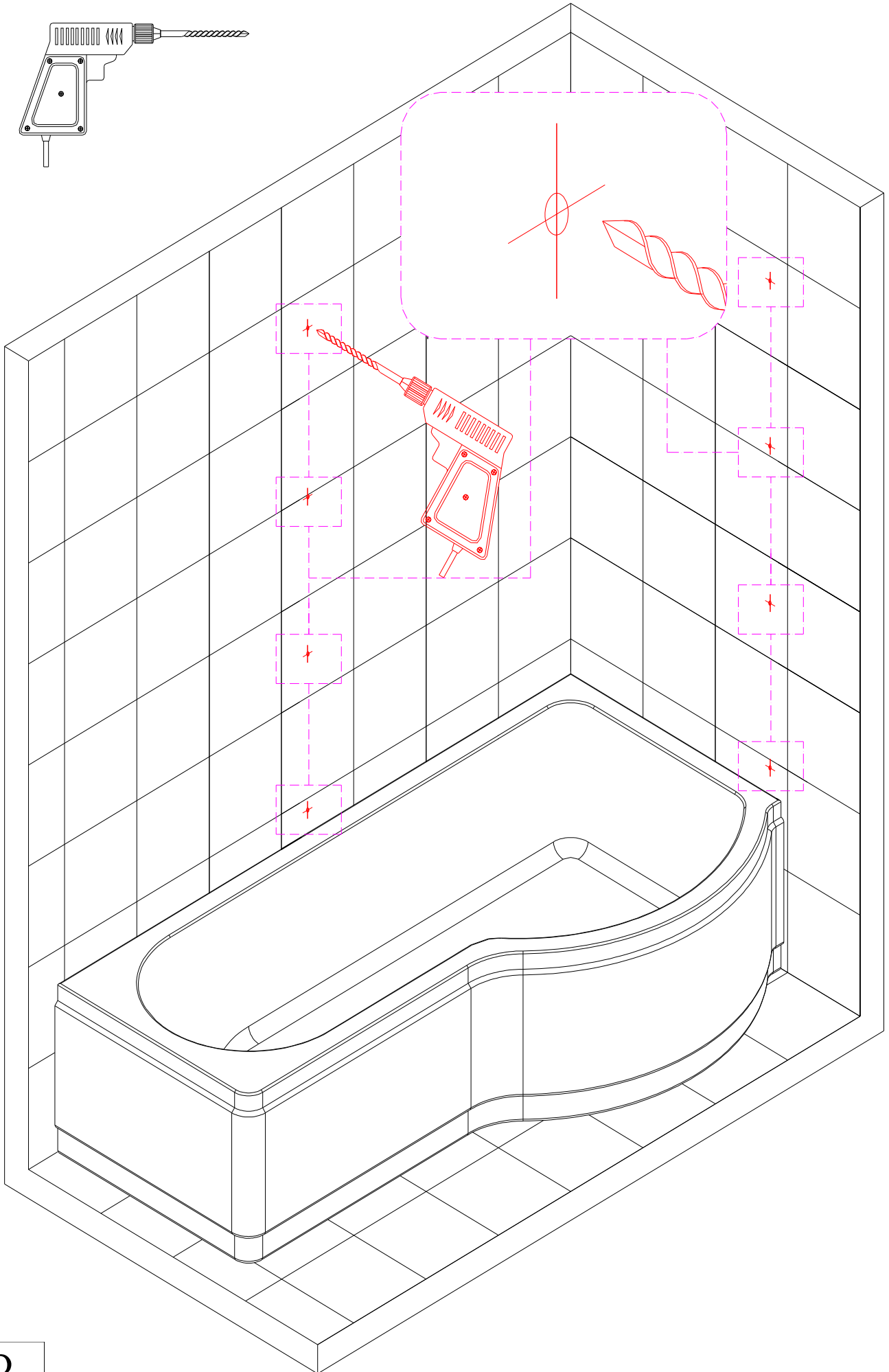
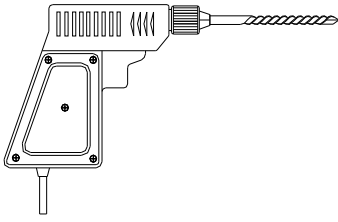

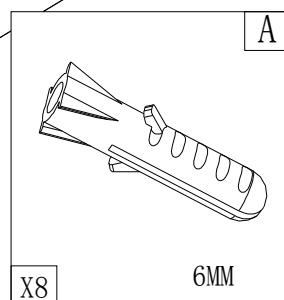
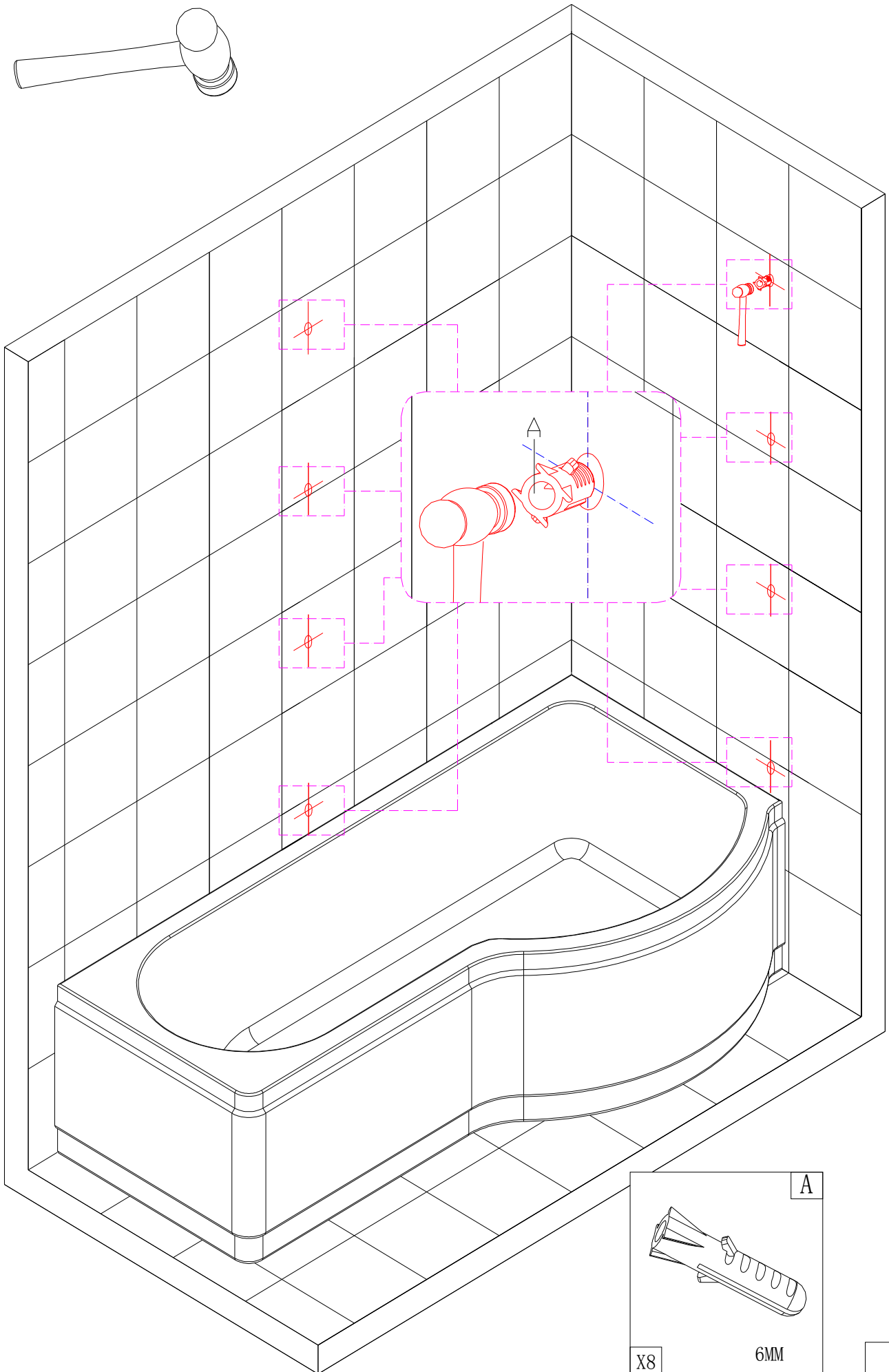
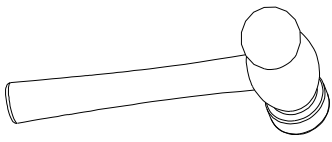

X8

6MM

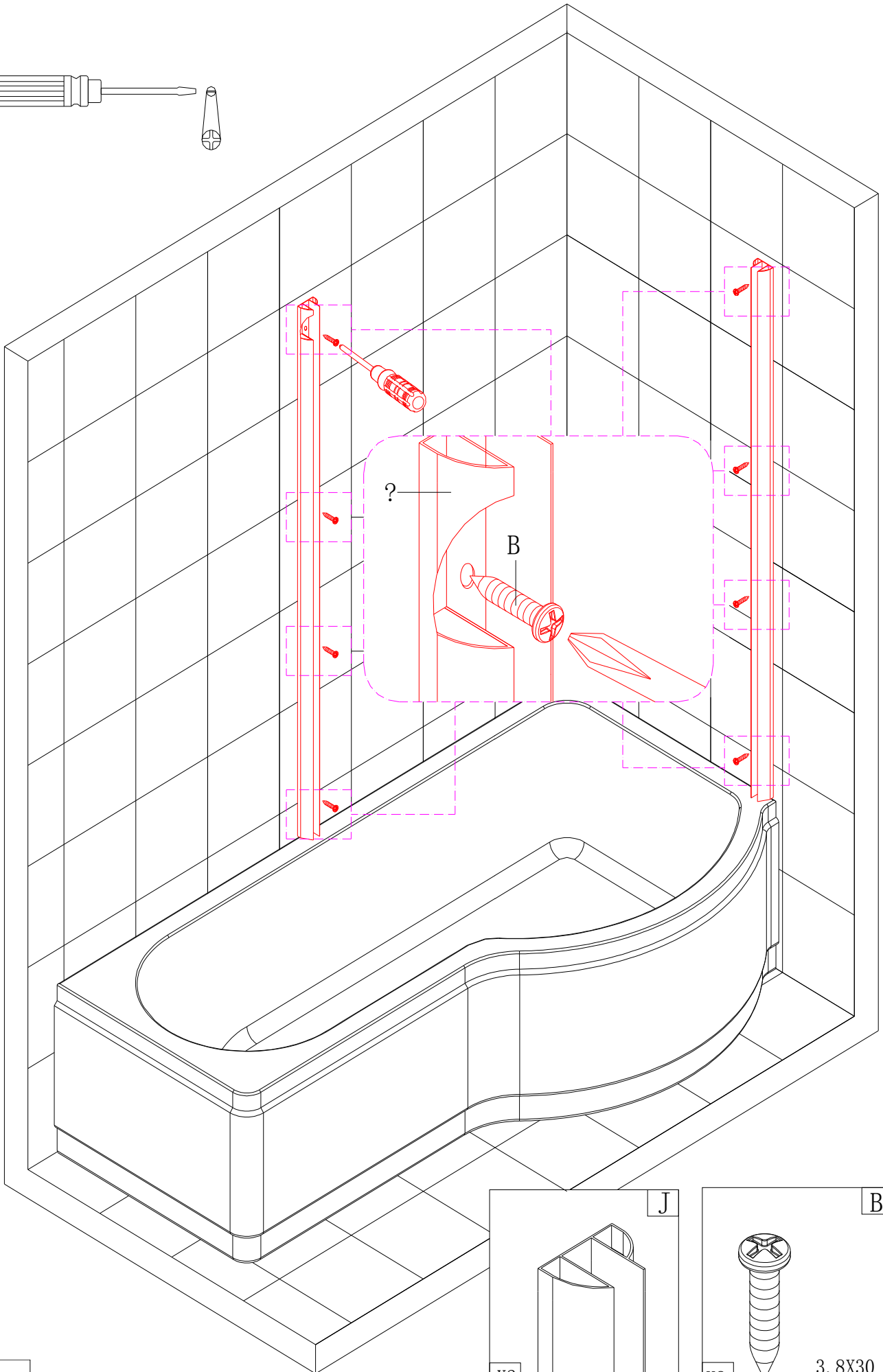
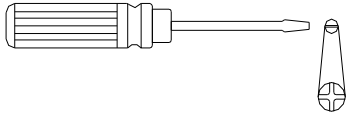

5

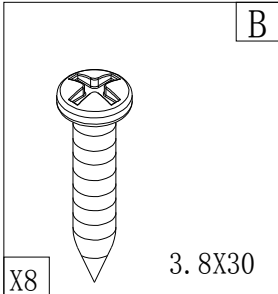
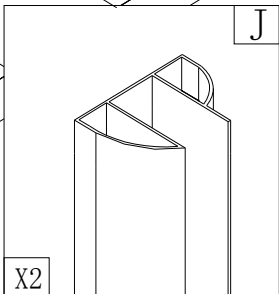

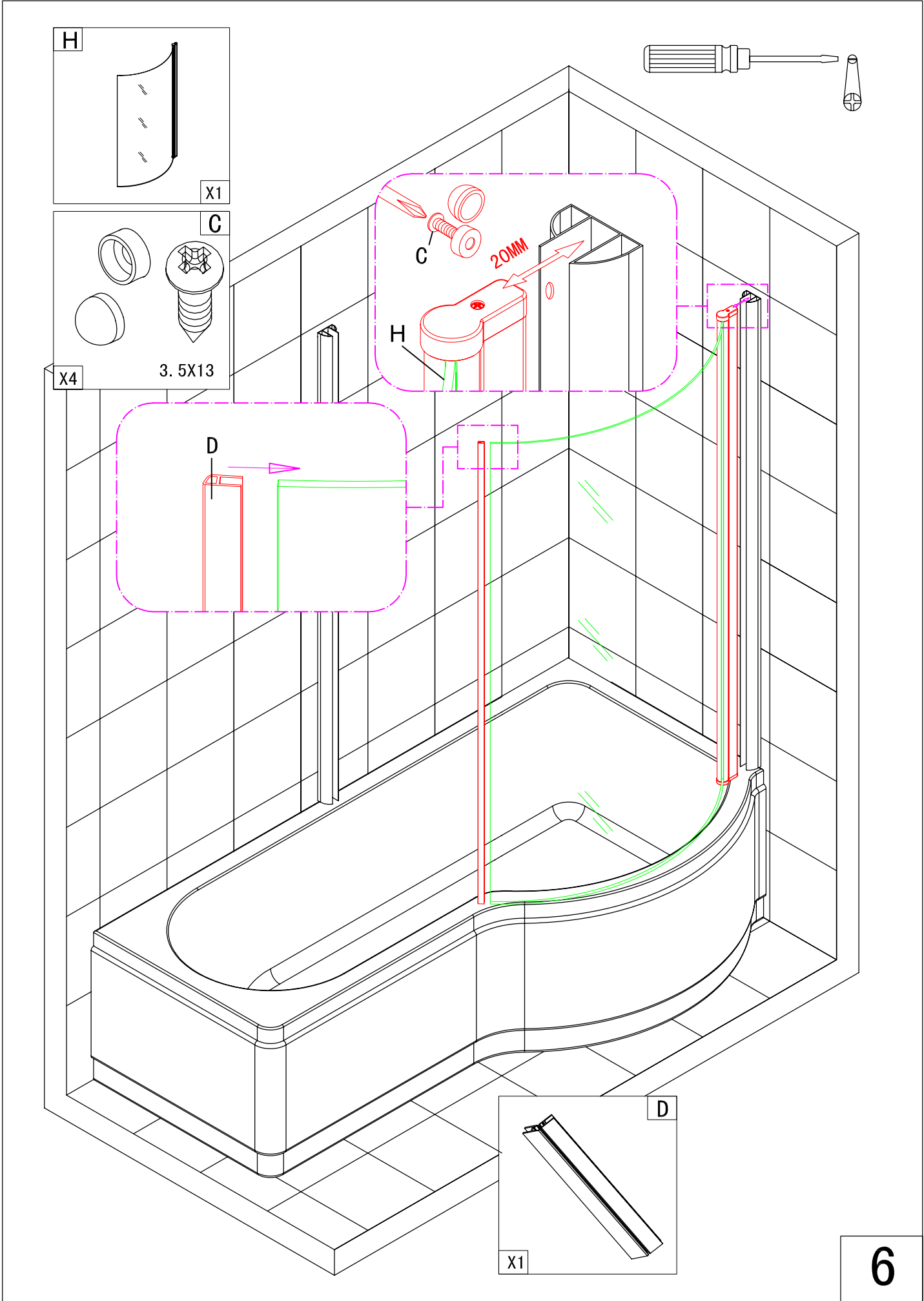

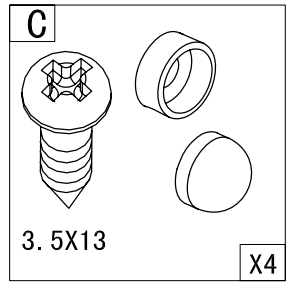
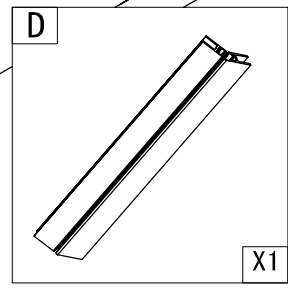
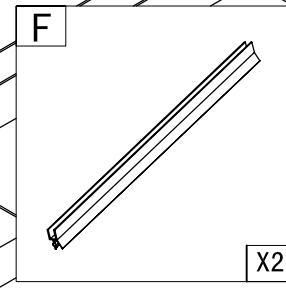
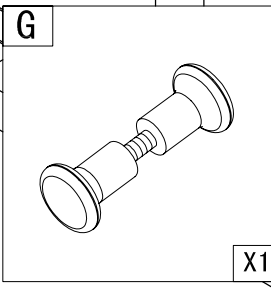
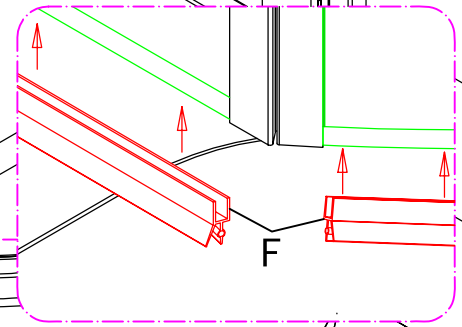
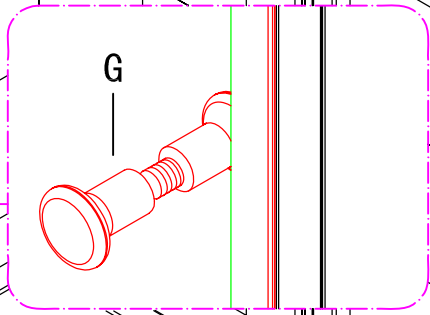
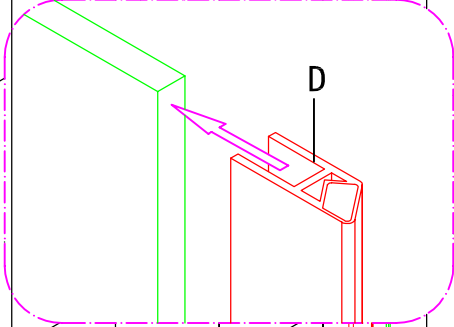
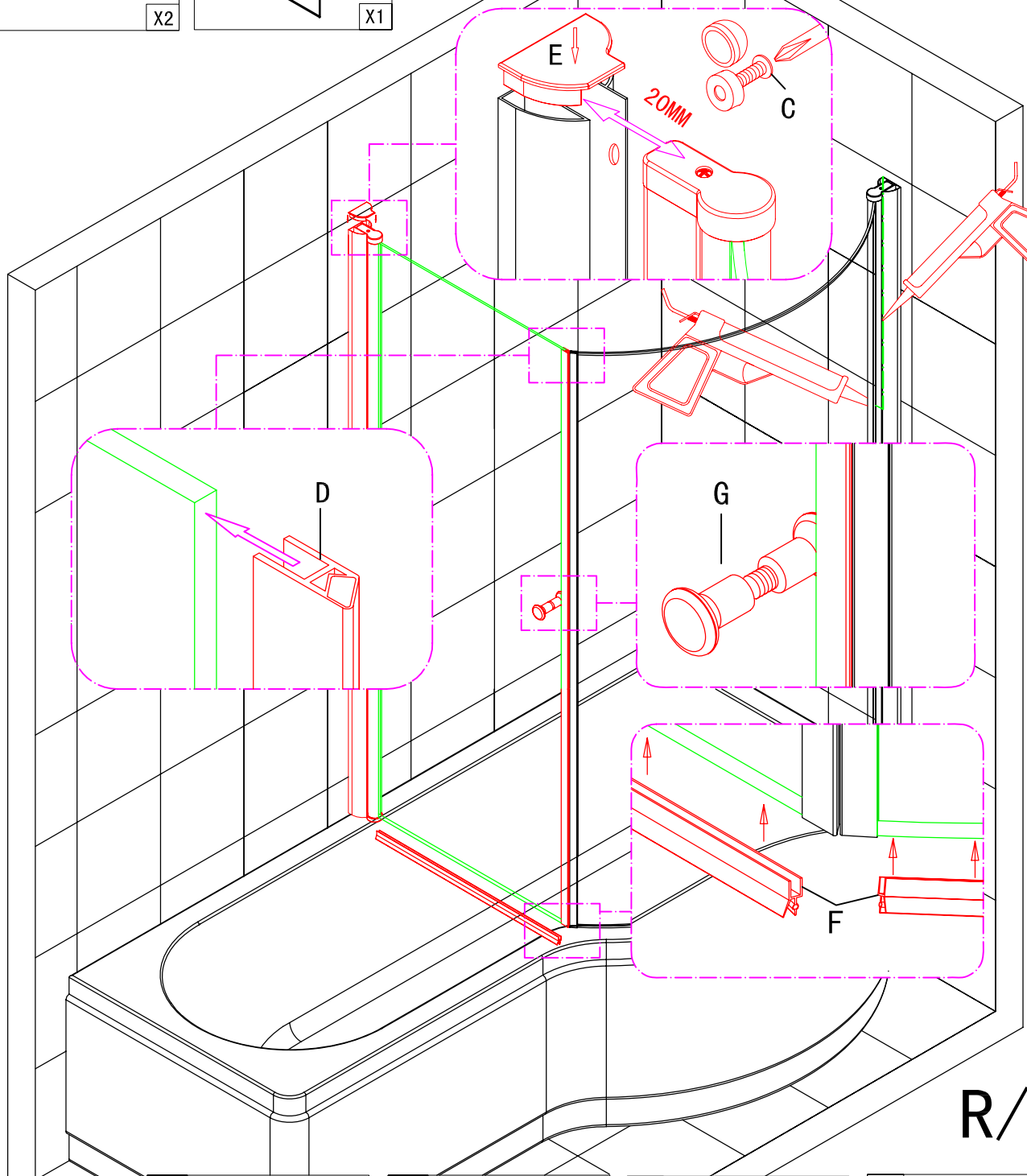
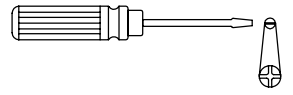
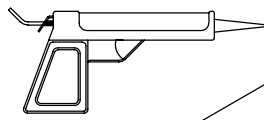
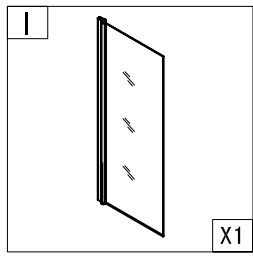
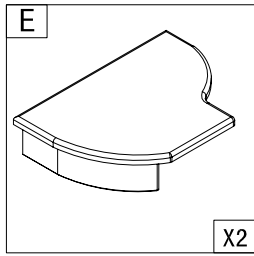

7

R/H

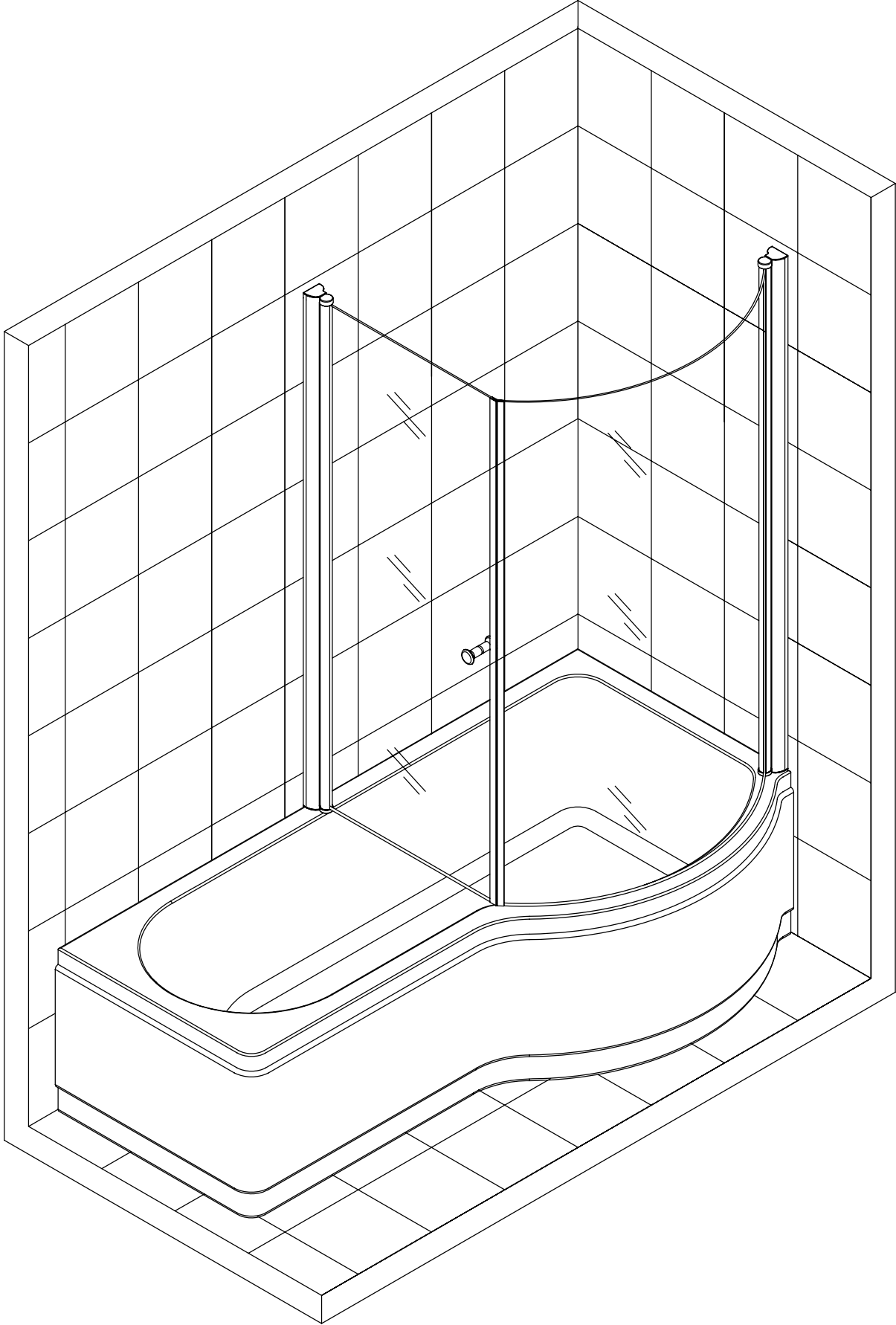



Eastbrook Co

Eastbrook Road
Gloucester GL4 3DB

www.eastbrooktrade.com

Cleaning and Maintenance of Shower Enclosures

Do not clean the shower enclosure with irritant detergents such as alcohol, bleach or other chemical cleaners.

Only clean with mild soapy water or a proprietary cleaner where the label advises it is suitable for the materials the enclosure is constructed from, test on a small area first.

For treating limescale we would recommend distilled vinegar in a half and half solution with water.

Following installation should you find that there is a notable noise when the glass door moves you may add a small amount of silicone lubricant onto the roller wheels and tracks, hinges or clips.

It is the responsibility of the product owner to maintain the product as recommended above. Also to check for parts which have broken or become loose to protect against future failure of the enclosure or screen.

Technical Helpline: 01452 317890

Open Mon-Fri 8am to 5pm

technical@eastbrookco.com