

## DATASHEET

### Image



### General Information

Product:	41.0314
Description:	Tuscan Multirail 650 x 450
Website Link:	<a href="#">(Click Here)</a>
Product Type:	Towel Rail
Brand:	Eastbrook Company
Colour:	Gloss White
Material:	Mild Steel
Height (mm):	650mm
Width (mm):	450mm
Net Weight (kg):	2.99kg
Product Range:	Tuscan

### Product Specifications

Warranty:	5 Year(s)
Supplied with fixings:	Yes
BTU $\Delta T50^{\circ}\text{C}$ :	480
BTU $\Delta T60^{\circ}\text{C}$ :	614
Watts $\Delta T50^{\circ}\text{C}$ :	141
Watts $\Delta T60^{\circ}\text{C}$ :	180

## Drawing

### Tuscan 650 x 450mm. Towel Rail Technical Drawing

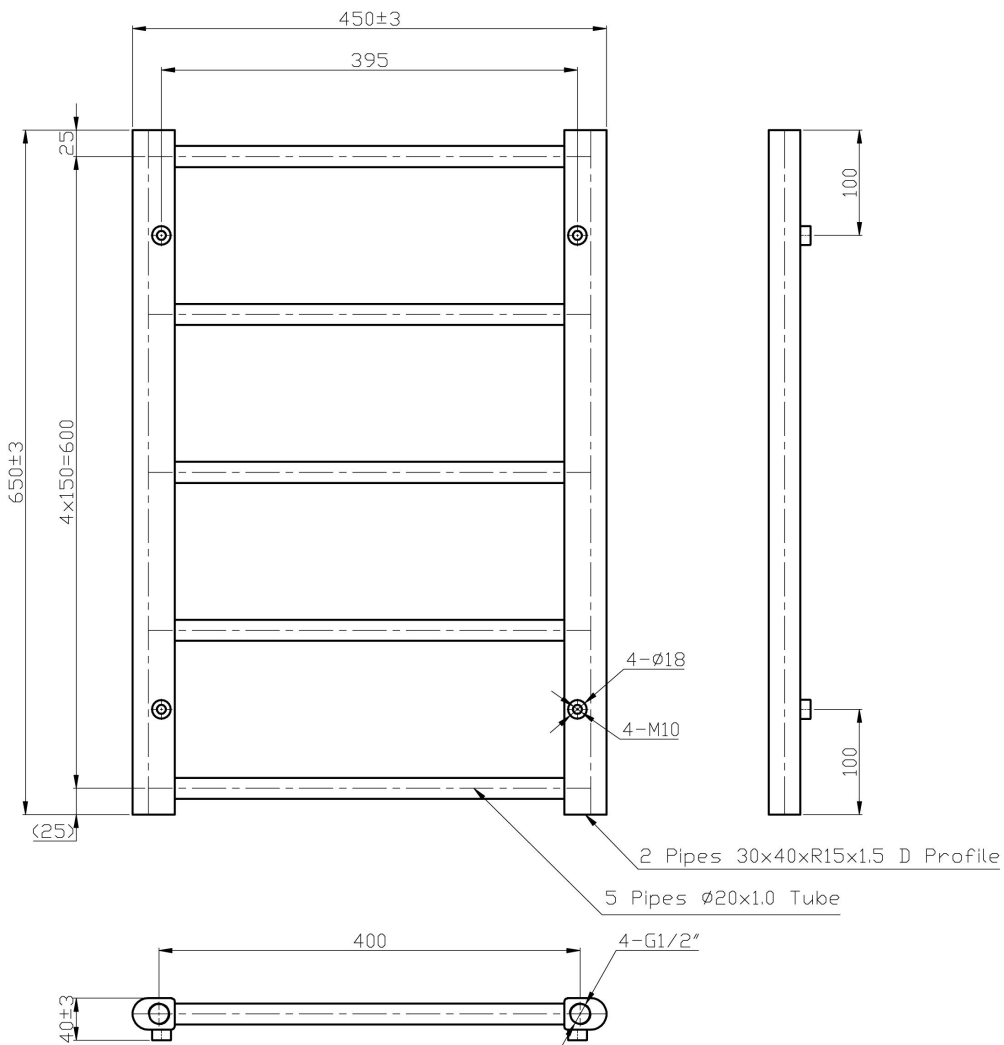

This product should be fitted by a fully qualified installer.

**Eastbrook**   
Eastbrook Road, Gloucester GL4 3DB  
Technical Helpline : 01452 317890  
Mon - Fri / 8am - 5pm  
Email : [technical@eastbrookco.com](mailto:technical@eastbrookco.com)