

DATASHEET

Image



General Information

Product:	8.031
Description:	Type E Element 150W
Website Link:	(Click Here)
Product Type:	Heating Element
Brand:	Eastbrook Company
Colour:	Chrome
Material:	
Net Weight (kg):	0.84kg
Product Range:	Type E Element

Product Specifications

Warranty:	1 Year(s)
Orientation:	
Watts:	150
Valve Types:	

Drawing

Type E Element - Chrome Technical Drawing

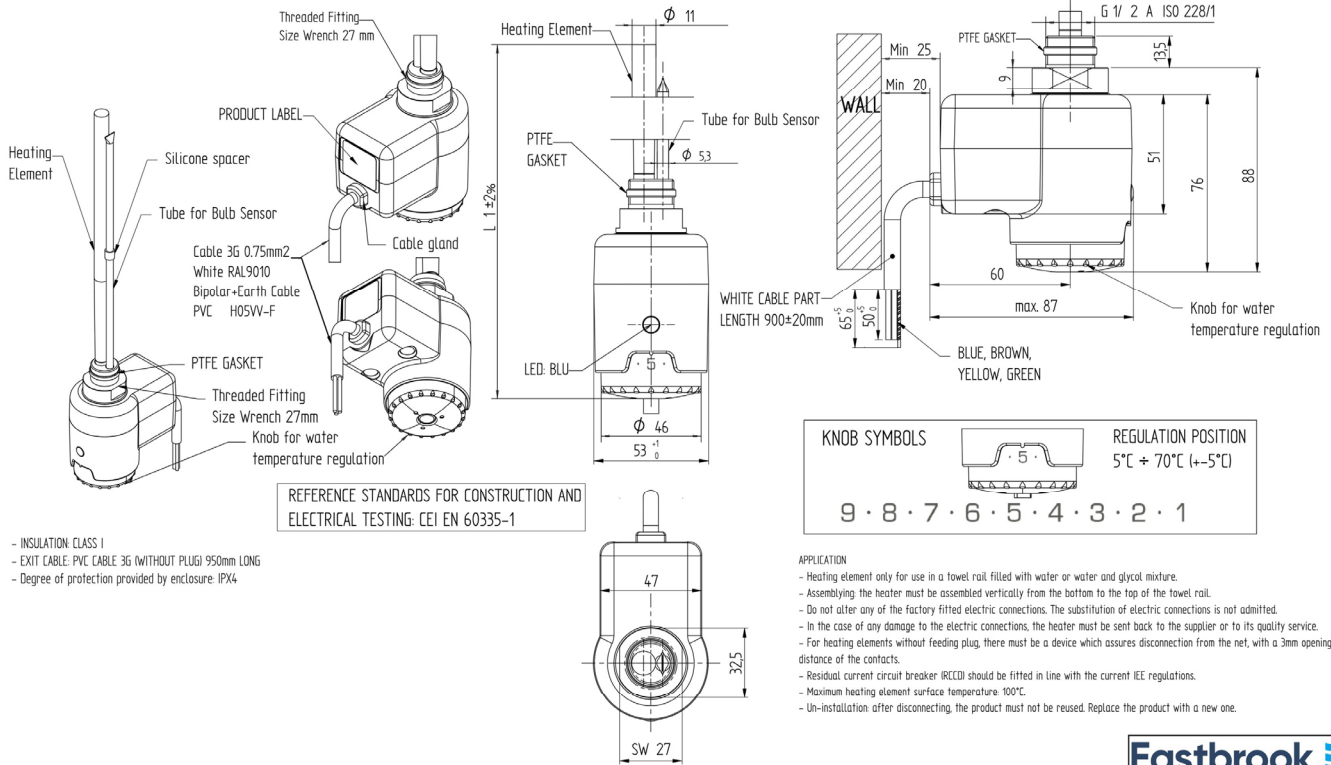

Eastbrook
 Eastbrook Road, Gloucester GL4 3DB
 Technical Helpline : 01452 317890
 Mon - Fri / 8am - 5pm
 Email : technical@eastbrookco.com