

INSTALLATION MANUAL

Eastbrook Code	Adjustment	Eastbrook Code	Adjustment
69.0082	655-695	69.0083	715-755
69.0084	755-795	69.0085	855-895

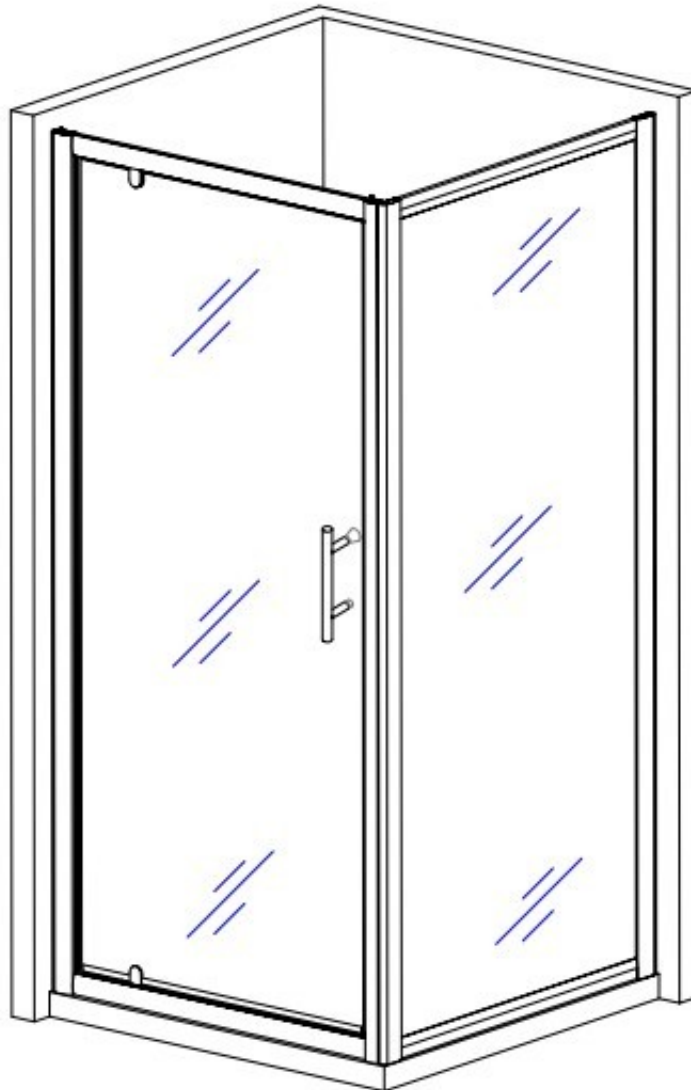

A711+B551

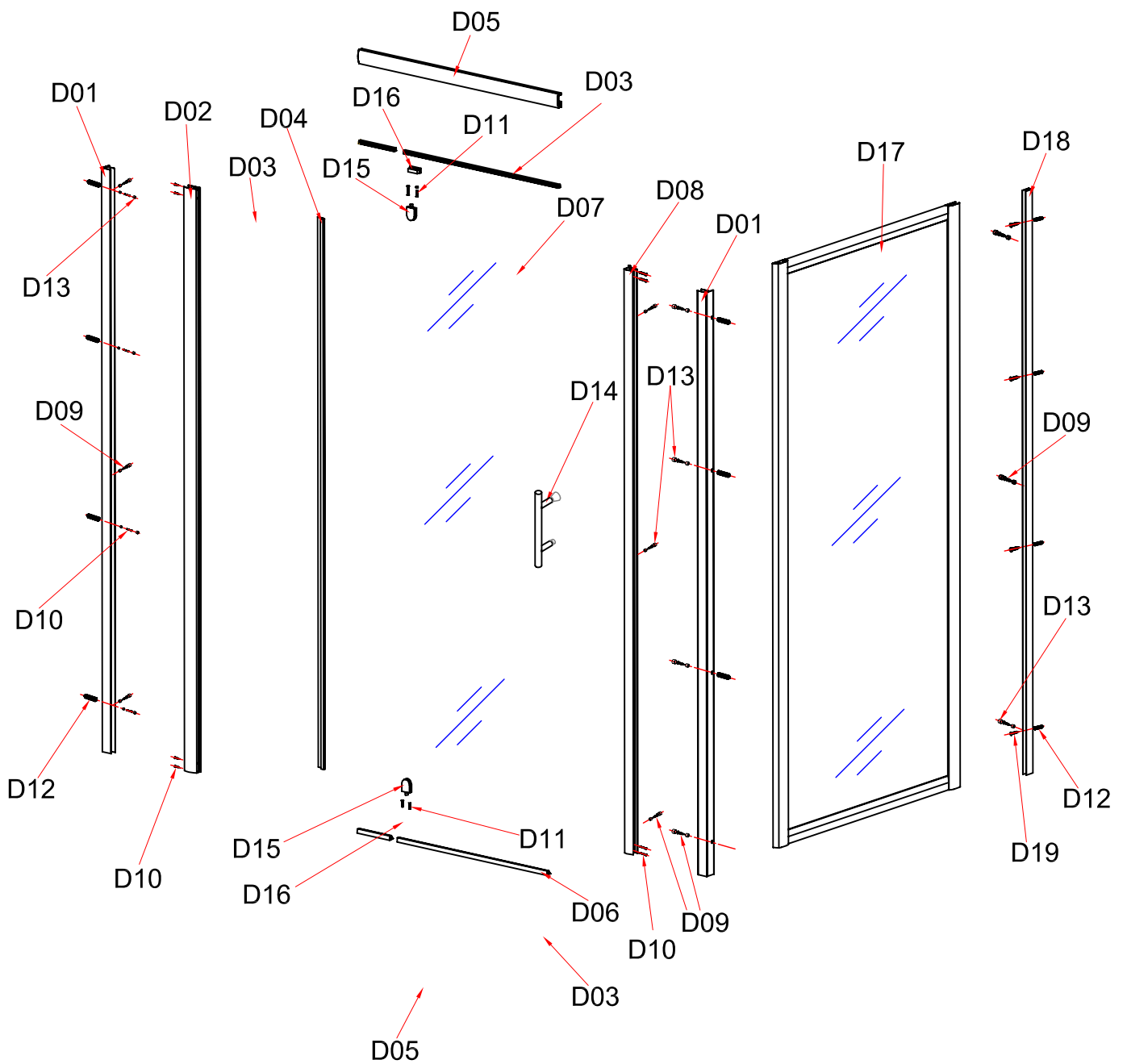

This product should only be fixed by a fully qualified installer

<p>D09</p> <p>10 ST4 13X</p>	<p>D10</p> <p>30 ST4 12X</p>	<p>D11</p> <p>16 M4 M4 4X</p>	<p>D12</p> <p>8X</p>	<p>D13</p> <p>17X</p>
<p>D14</p> <p>1X</p>	<p>D15</p> <p>2X</p>	<p>D16</p> <p>2X</p>	<p>D19</p> <p>30 ST4 4X</p>	

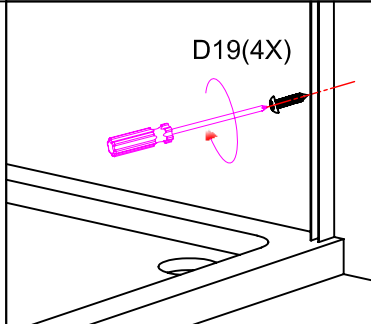
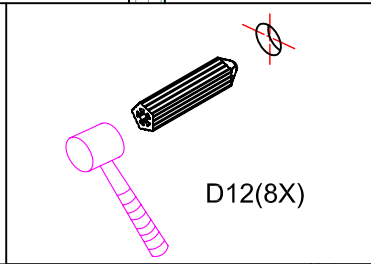
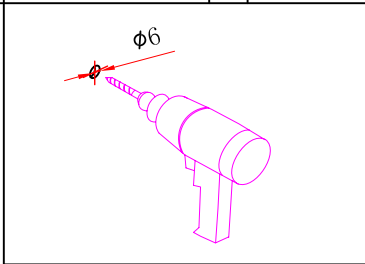
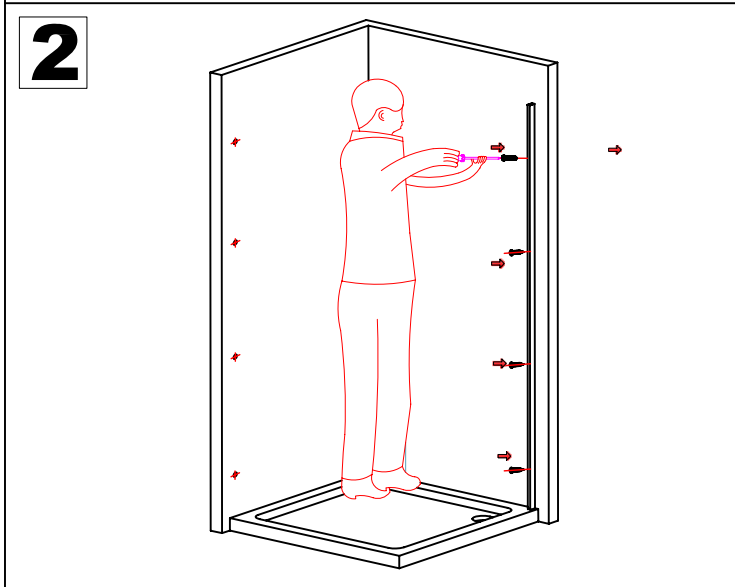
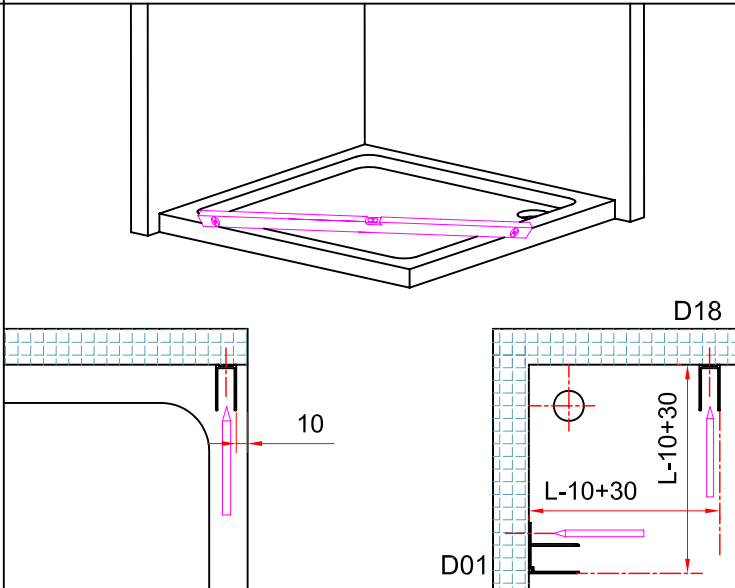
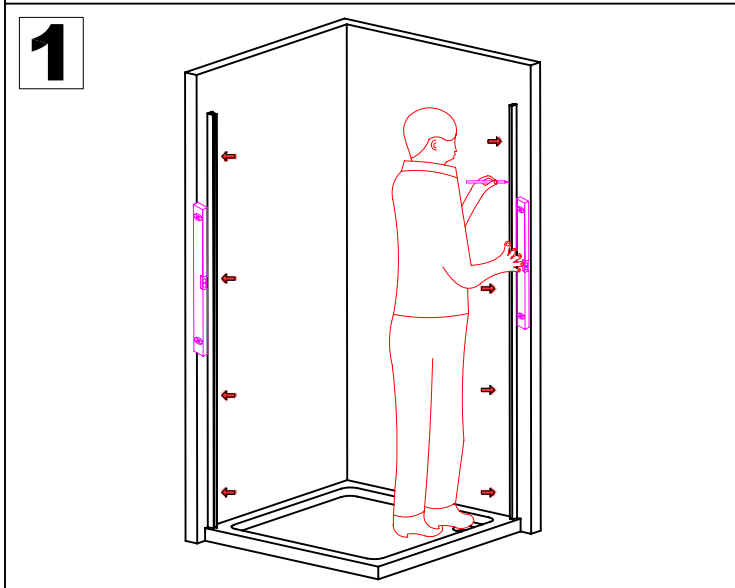
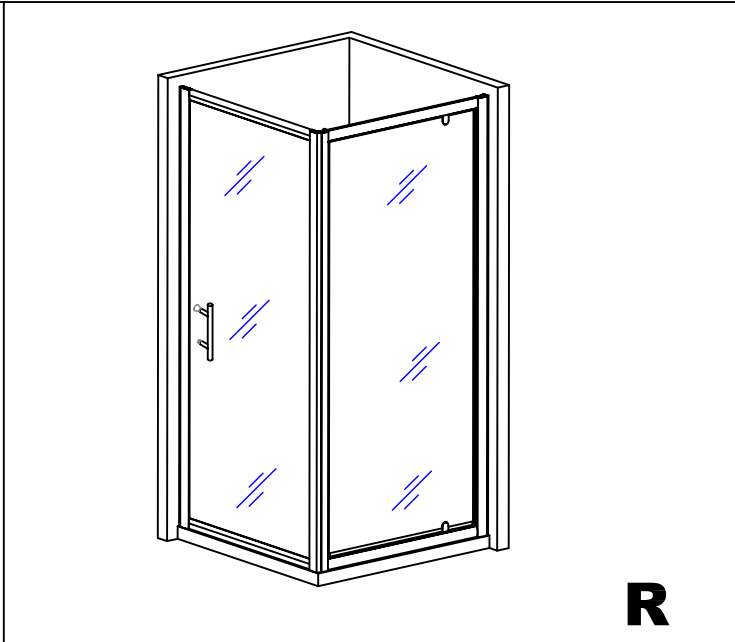
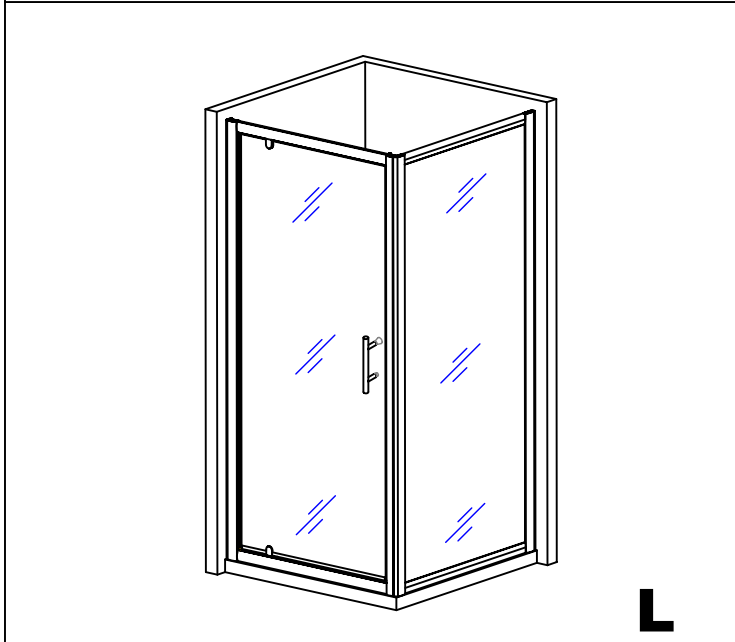
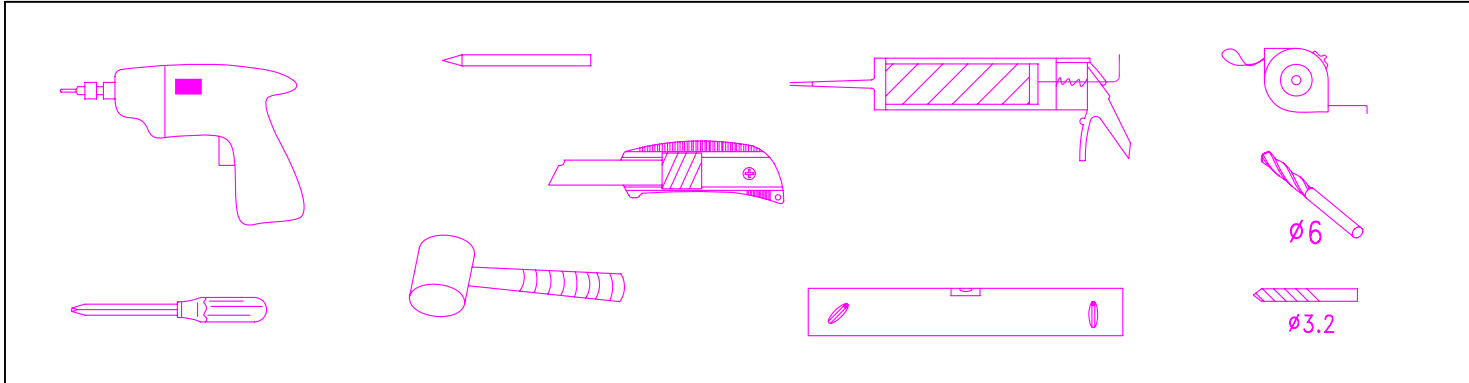

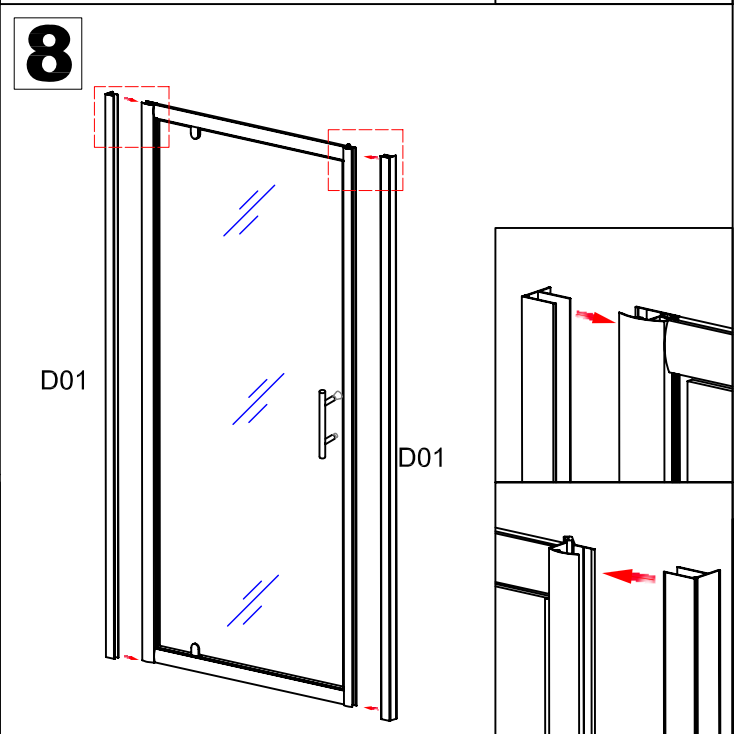
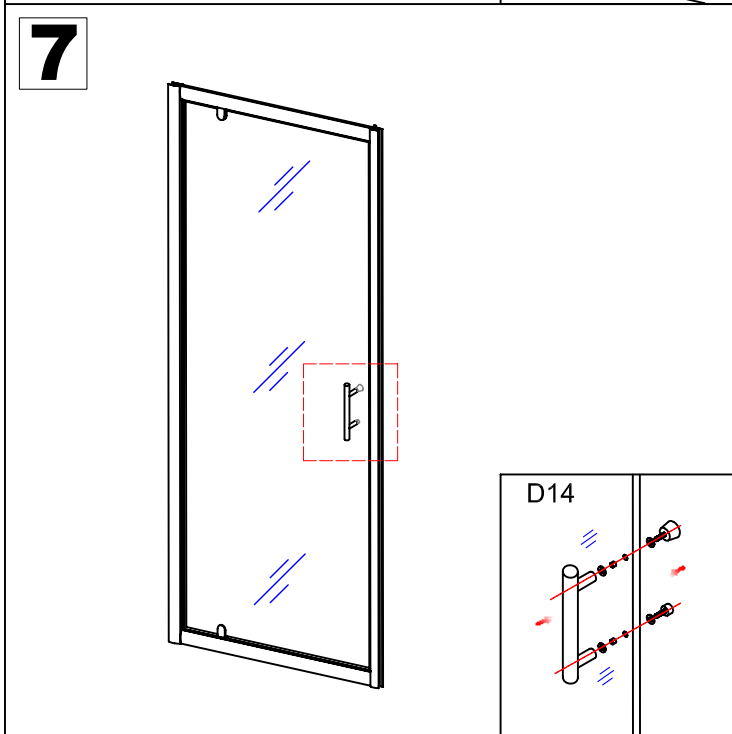
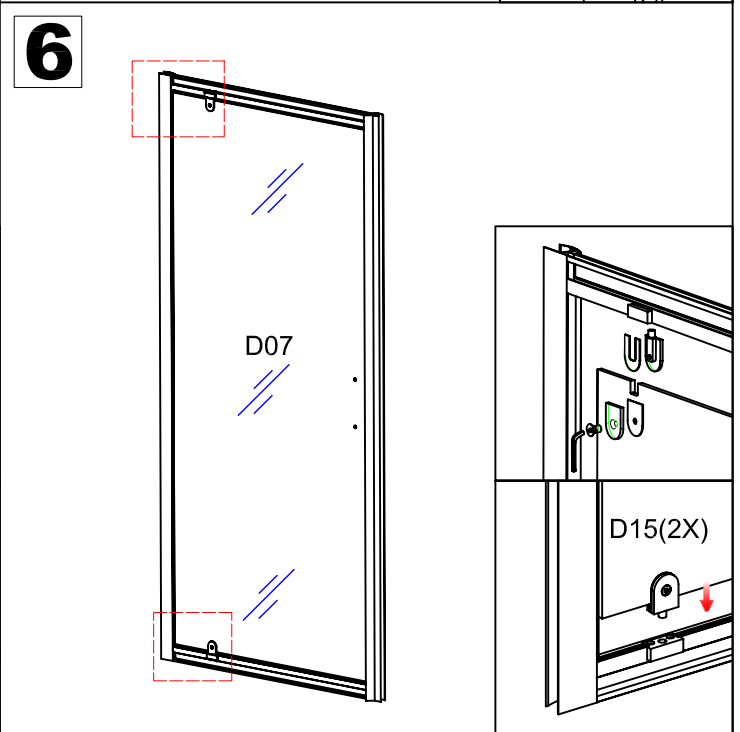
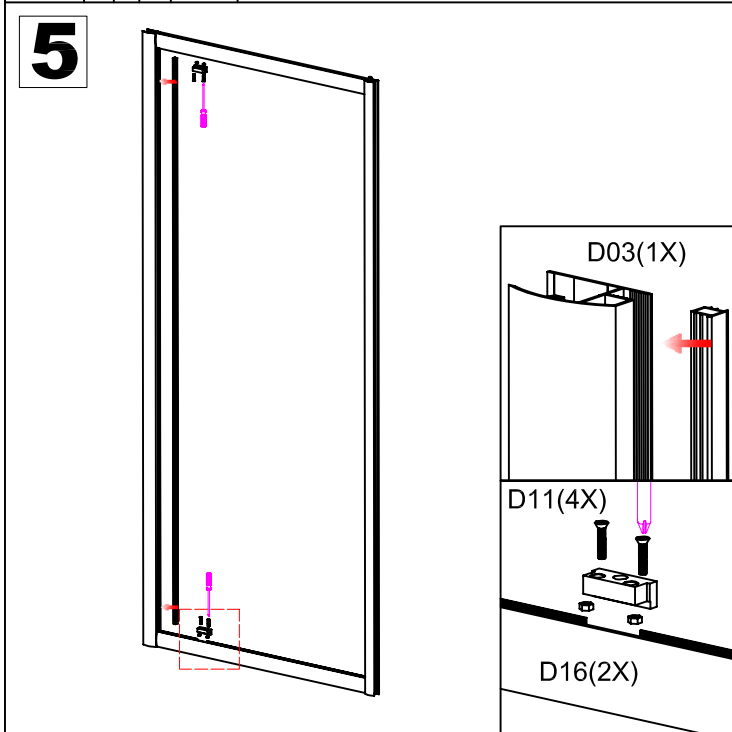
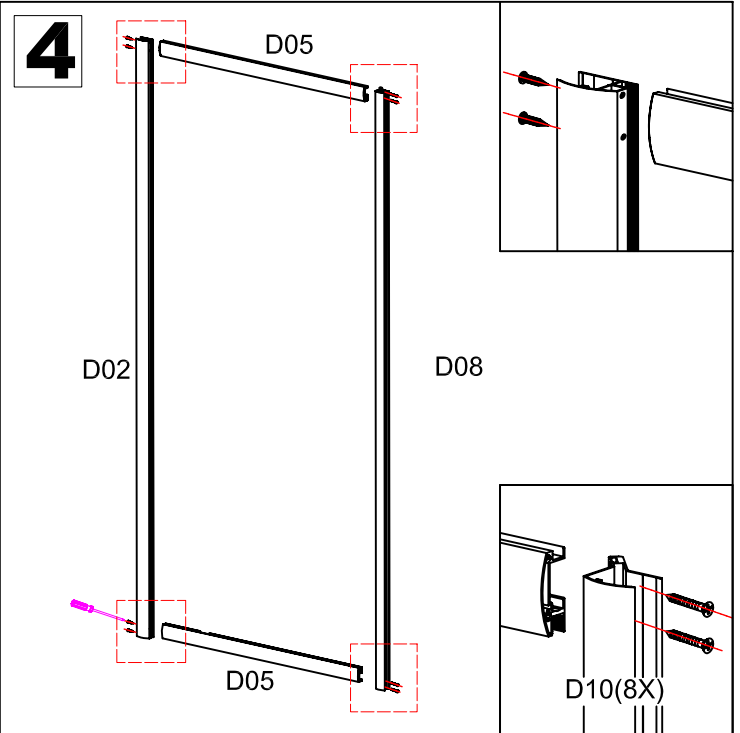
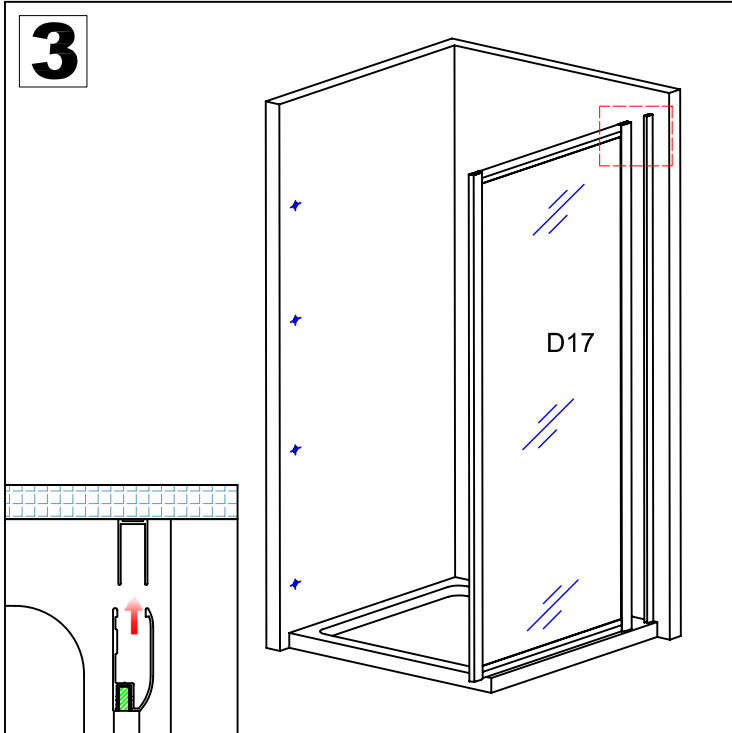

9

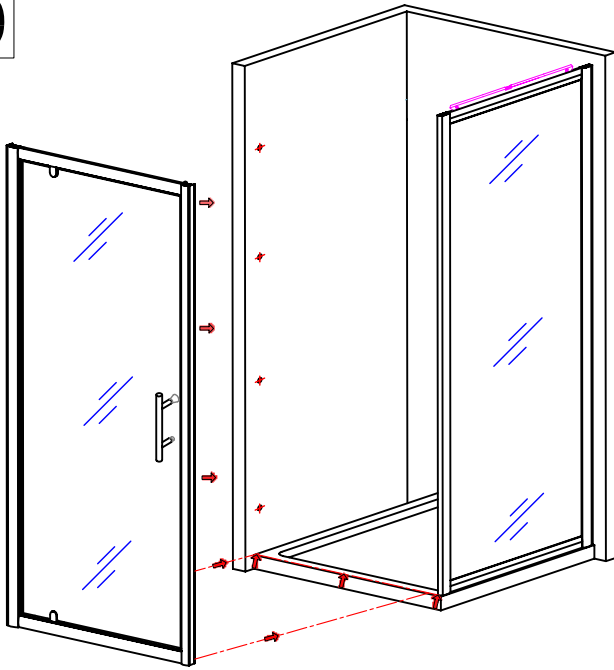

10

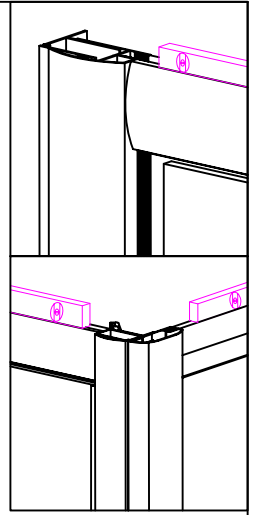
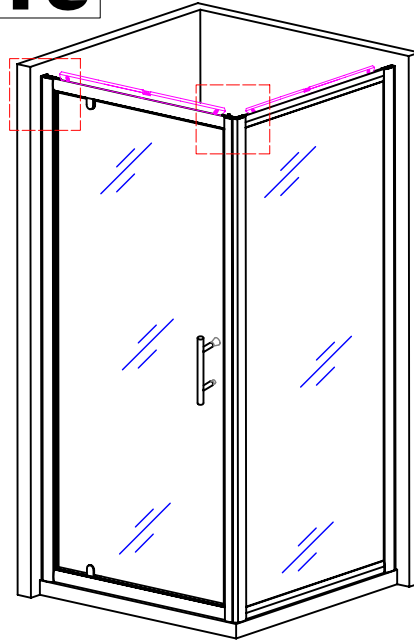

11

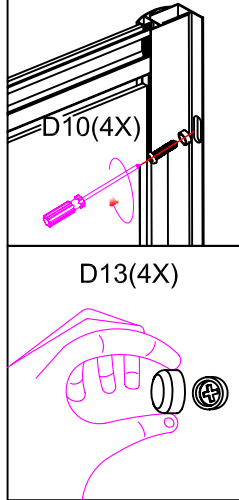
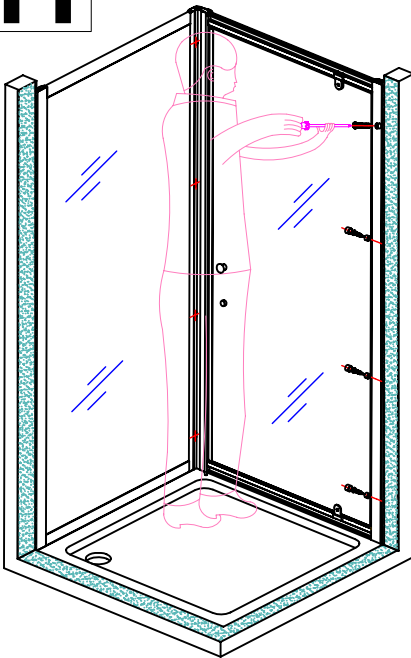

12

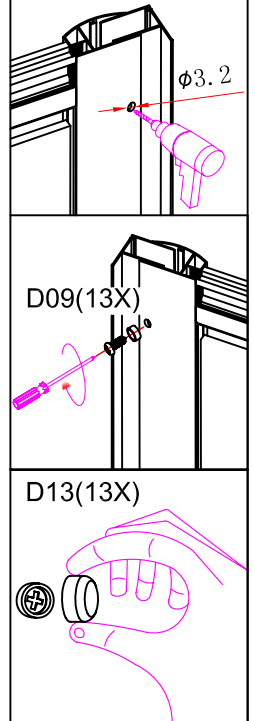
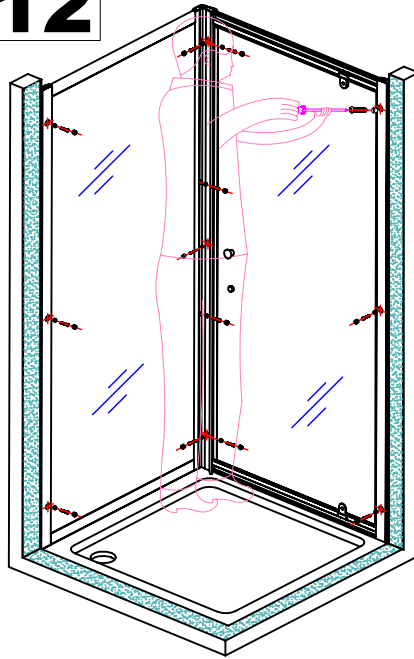

13

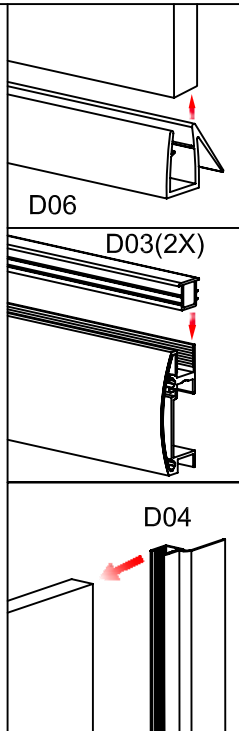
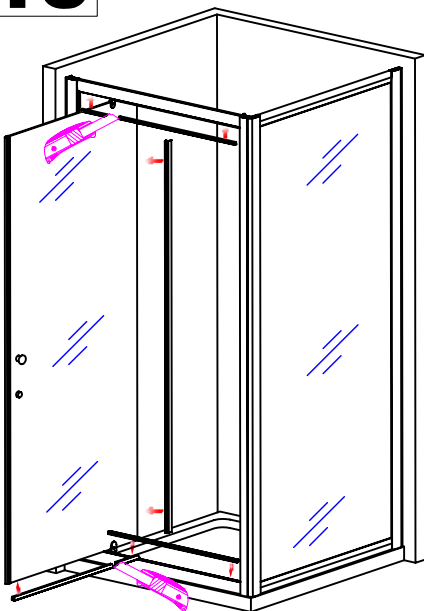

14

Silicone on the outside of the screen only

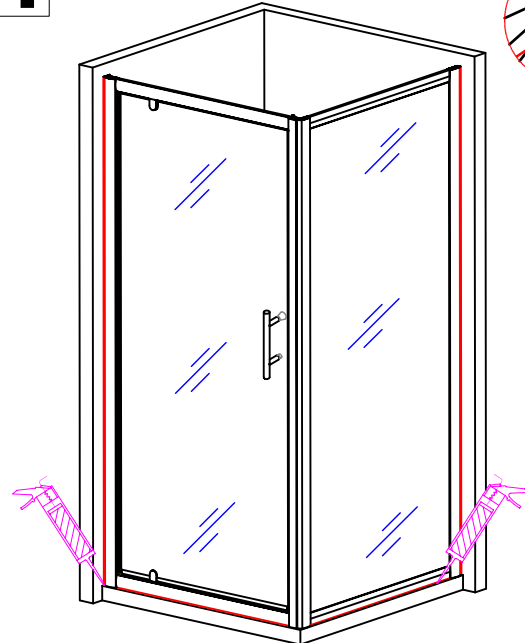

Cleaning & Maintenance

Don't clean the shower enclosure with irritant detergent such as alcohol,bleach or other chemical cleaners.

Only clean with warm soapy water.

After the installation is completed,should you find that there is notable noise when the glass door moves,you may add a small quantity of lubricant onto the roller wheel,slipping hook and the track.

Helpline: 01452 317890