

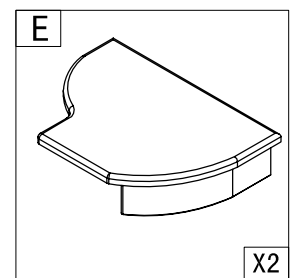

manual

Prado/Sigma/Delta Screen Type 1-2

Pivot door

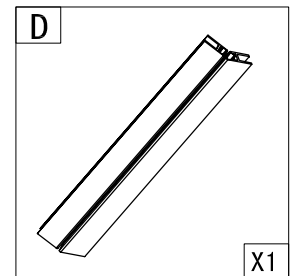
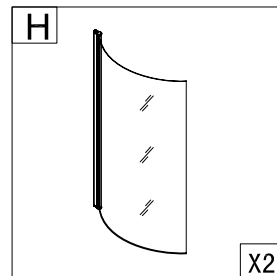
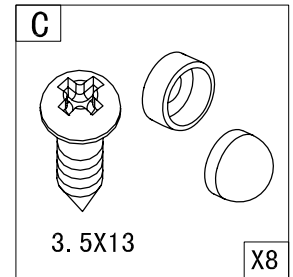
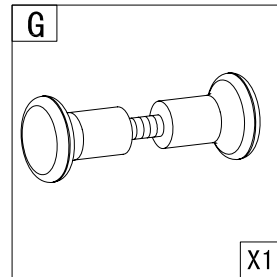
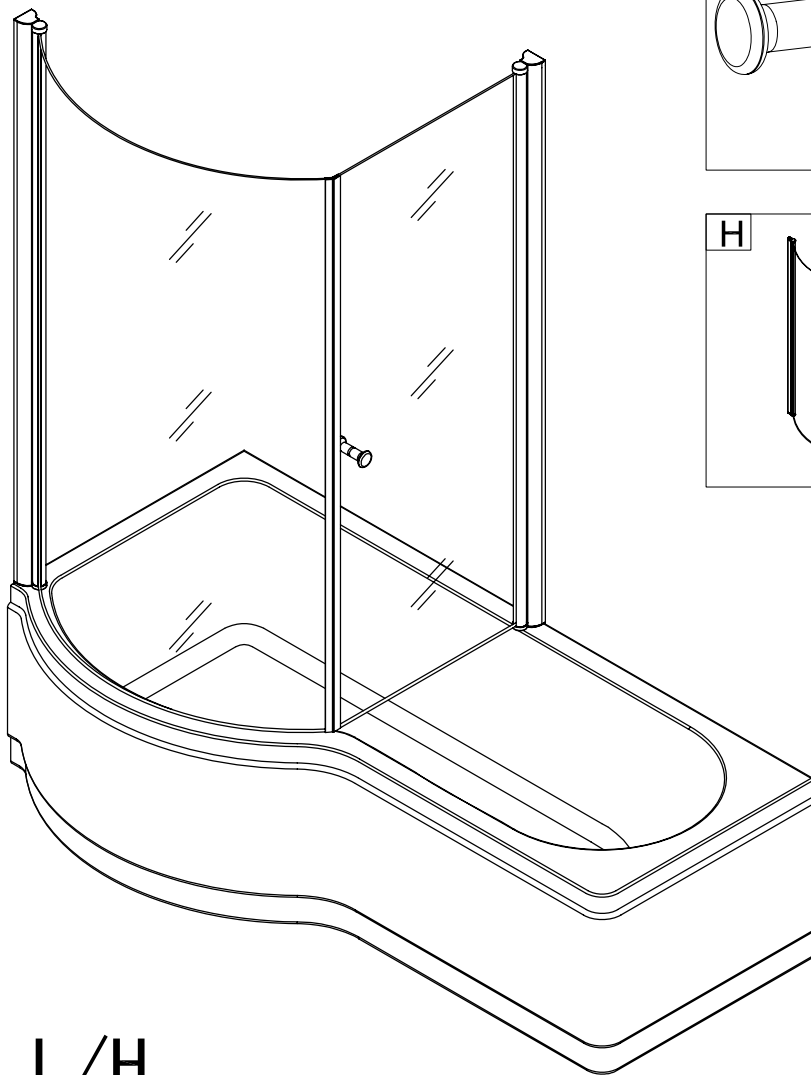
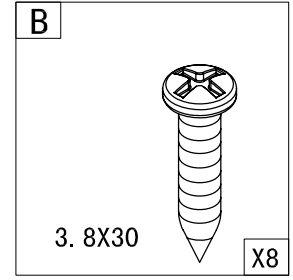
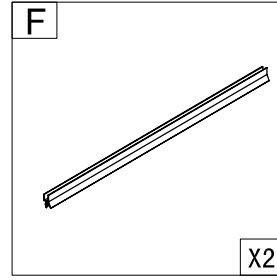
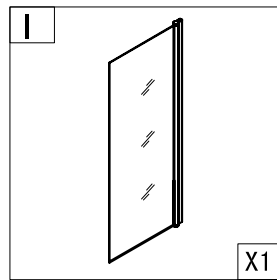
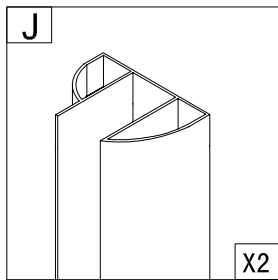
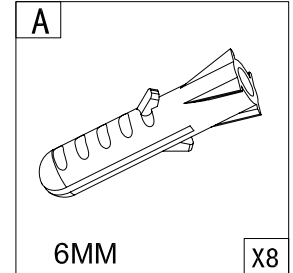
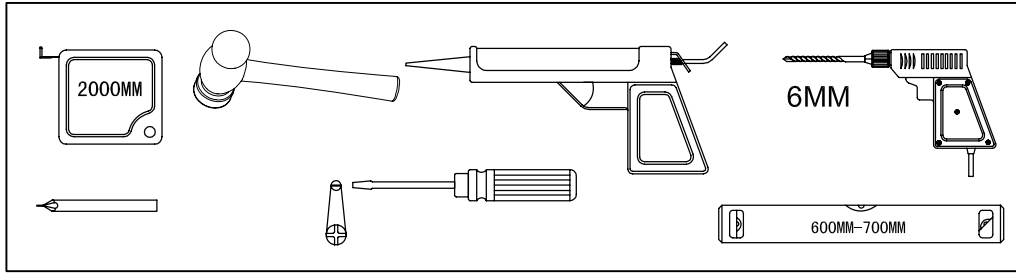

L/H

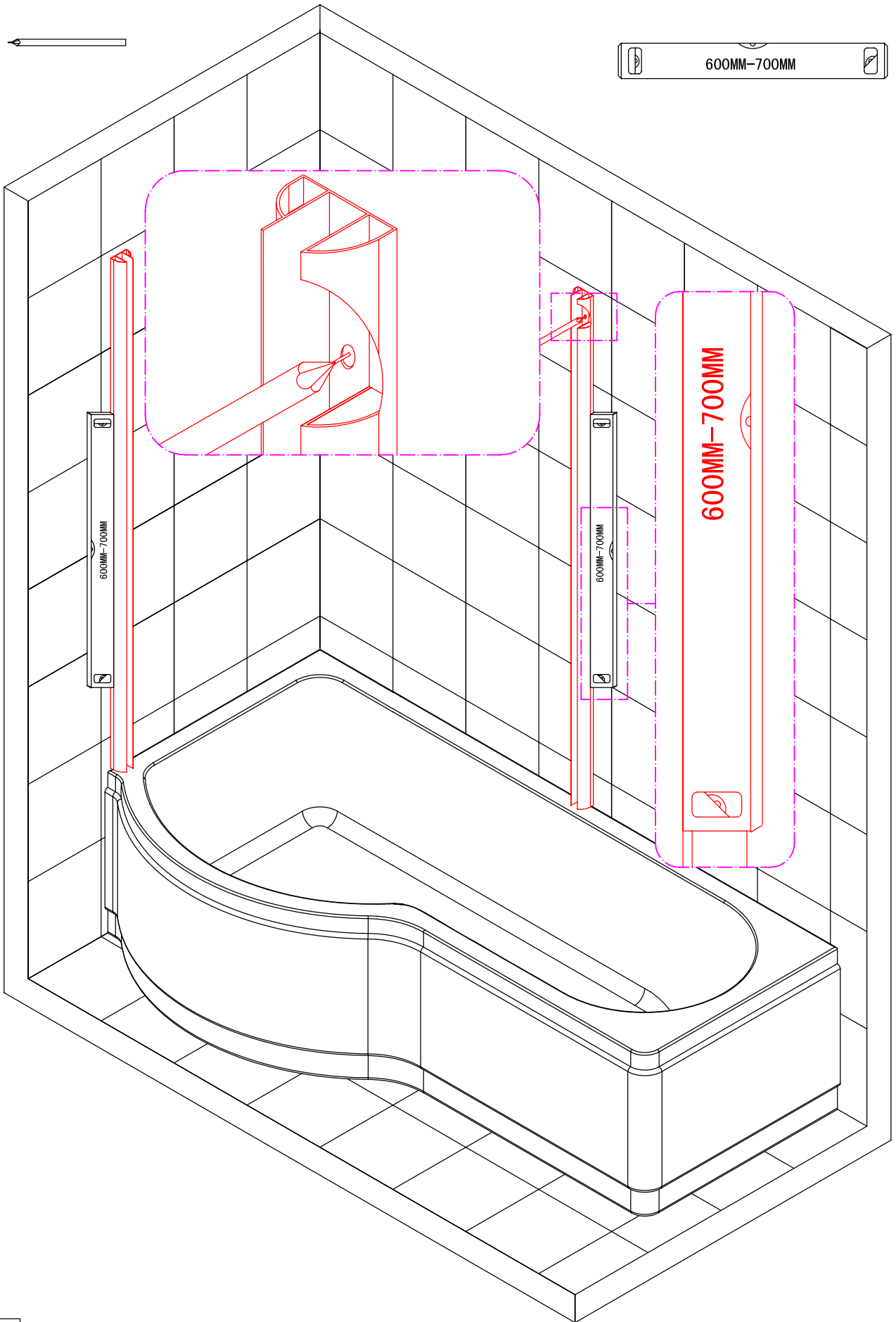
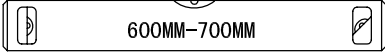
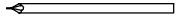

2

Dry fit required for best position to connect wall profile!

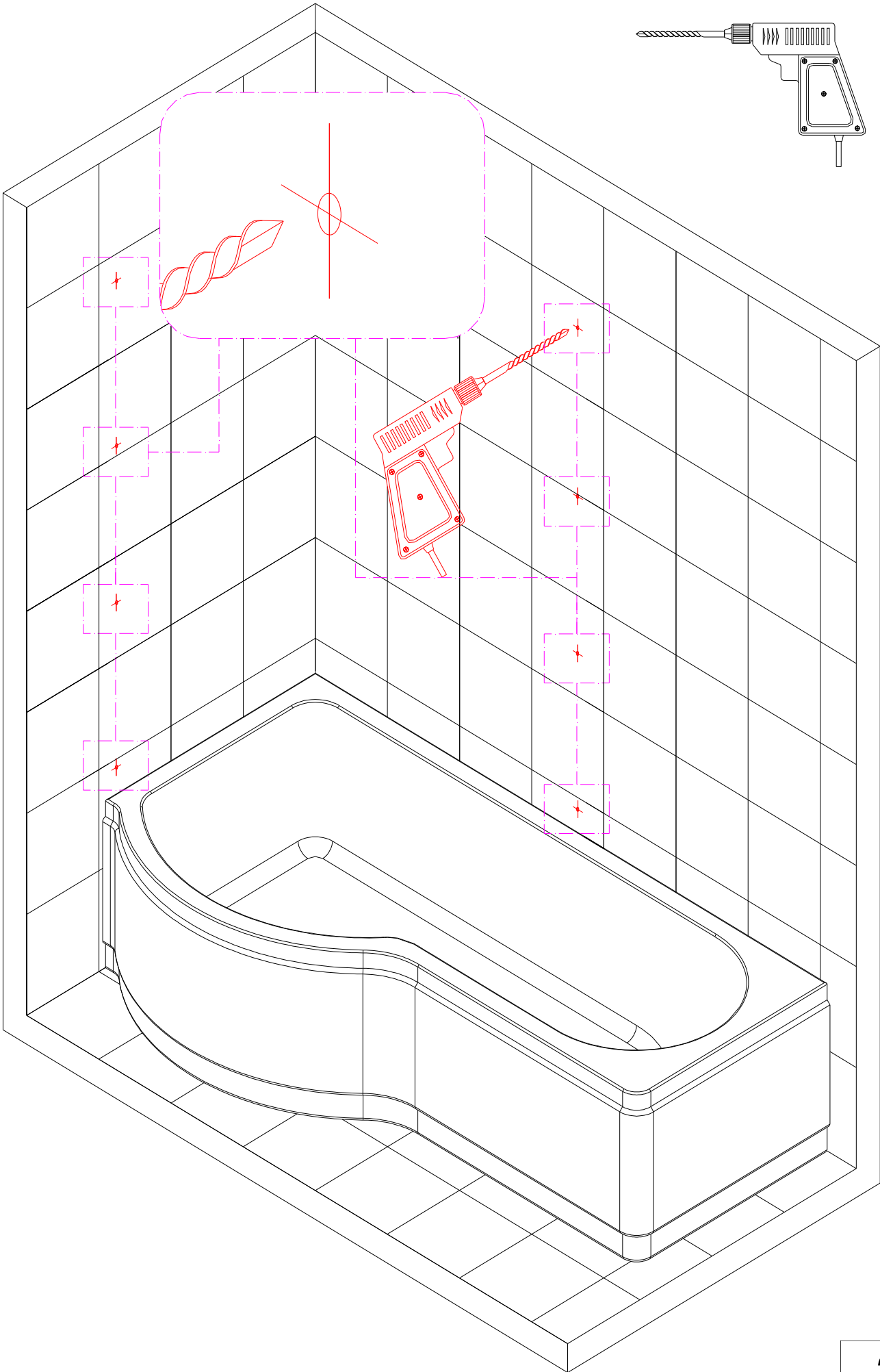
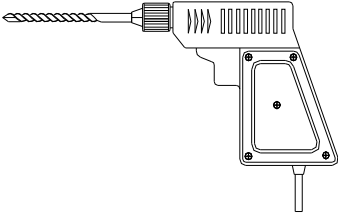

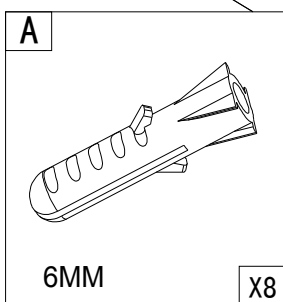
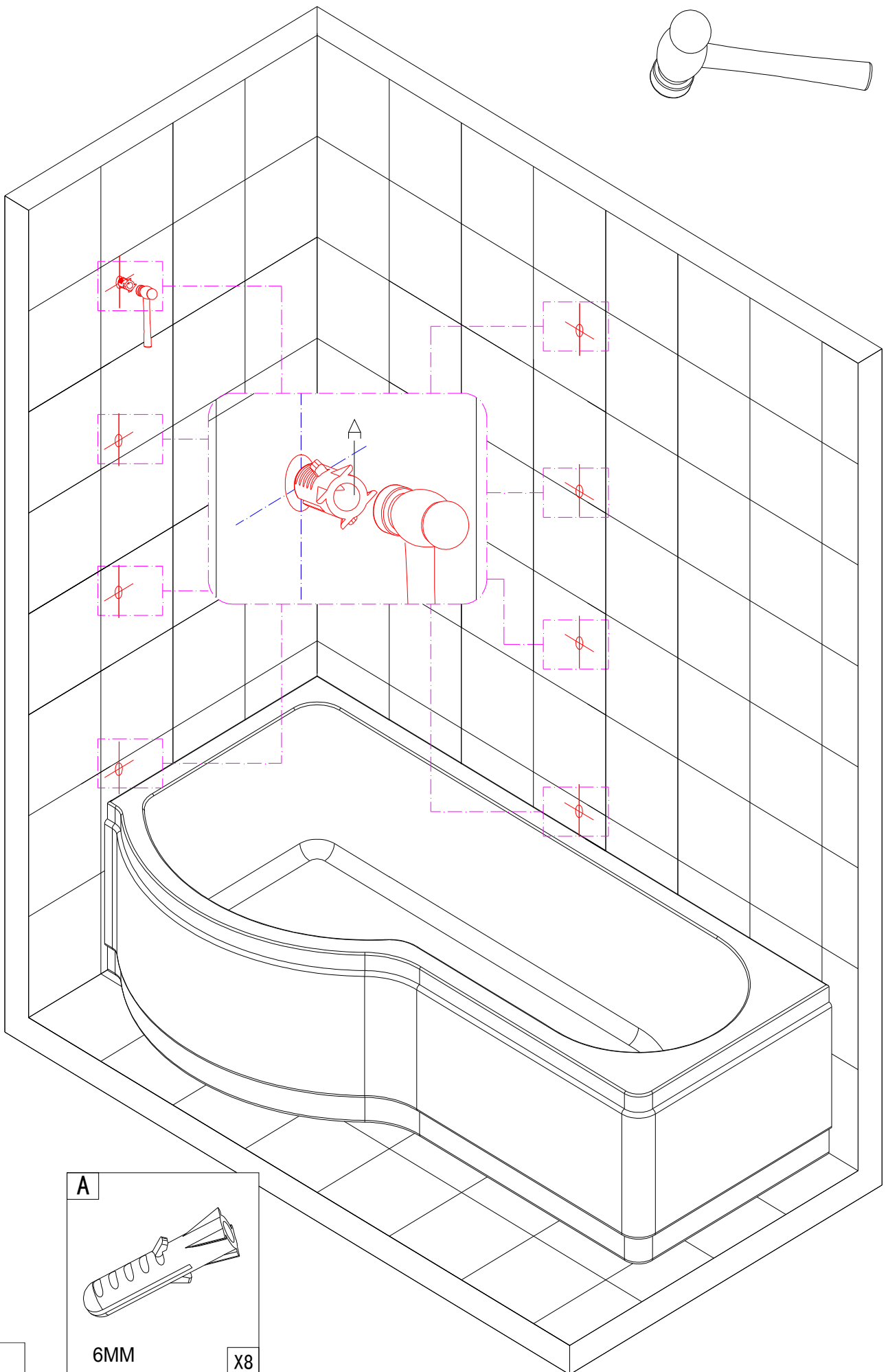
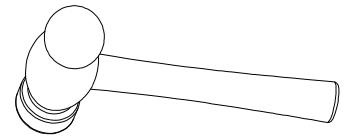

4

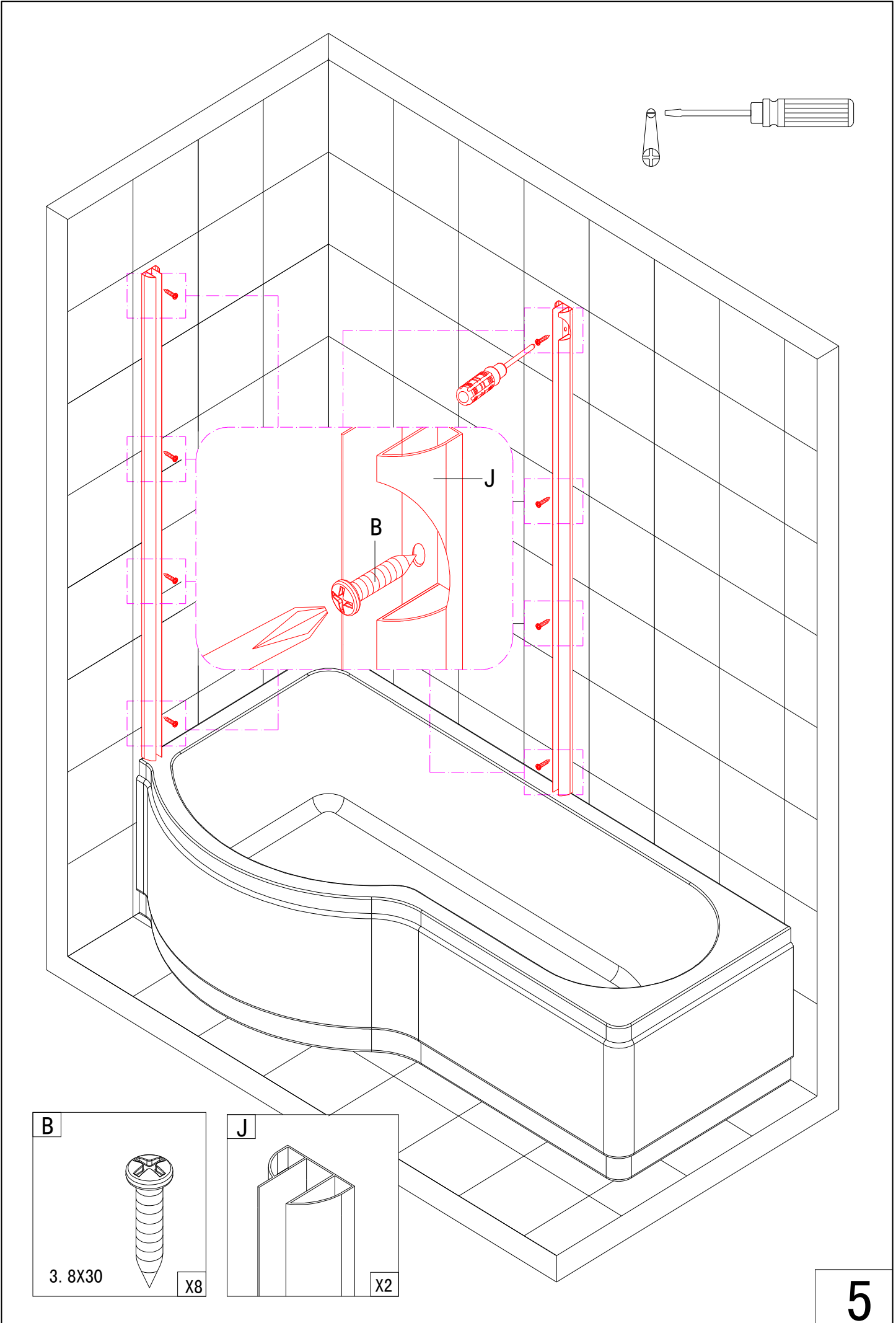

B

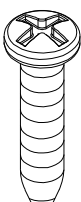

3. 8X30

X8

J

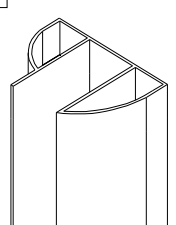

X2

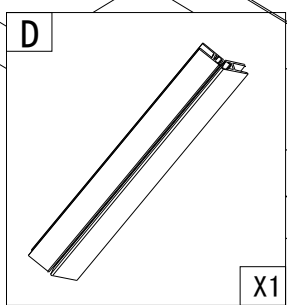
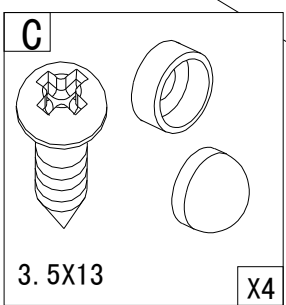
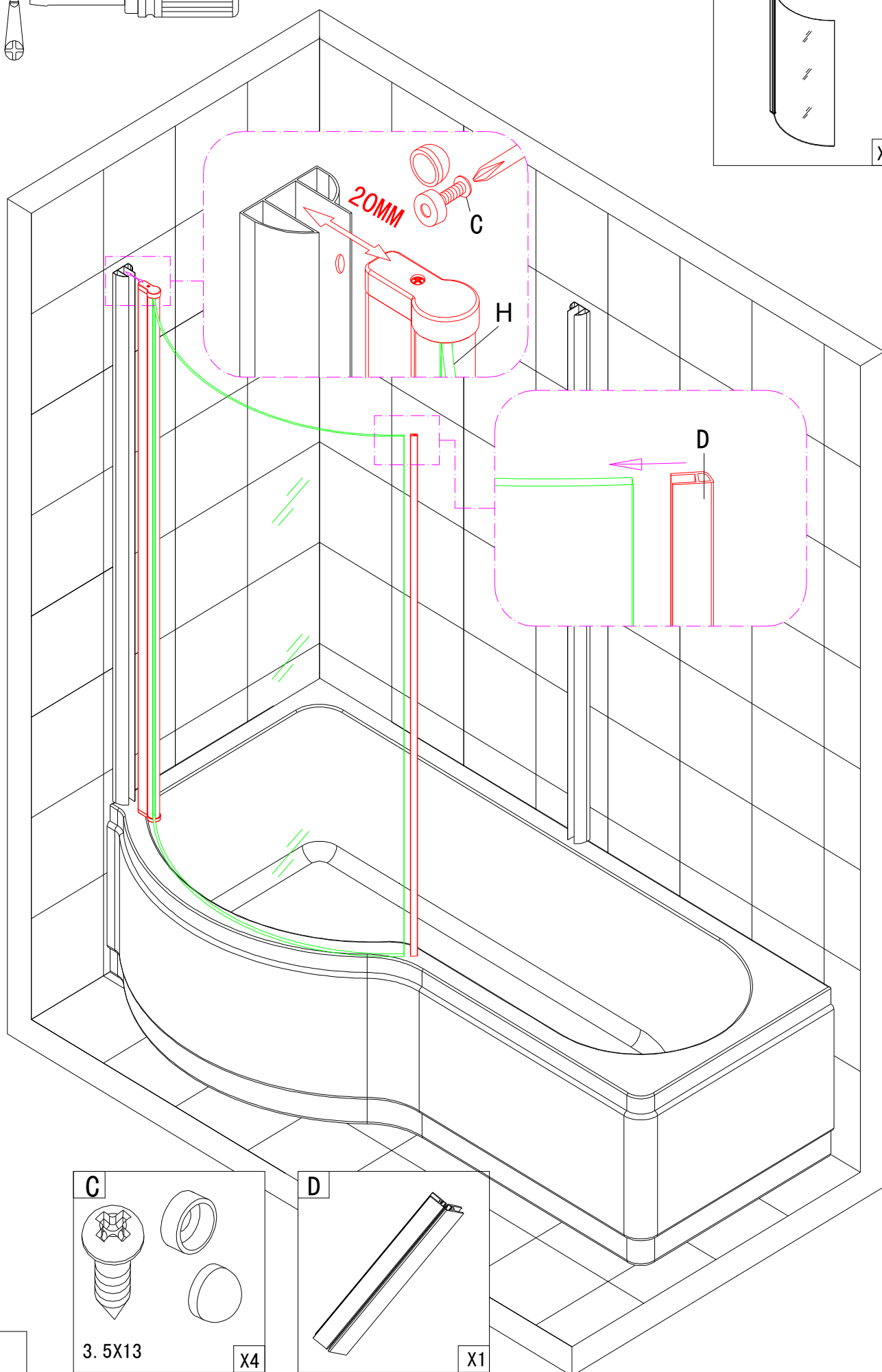
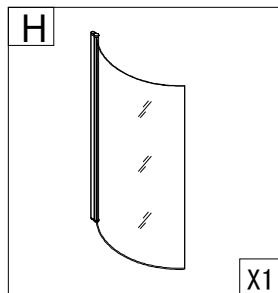
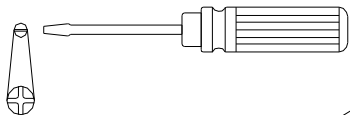

6

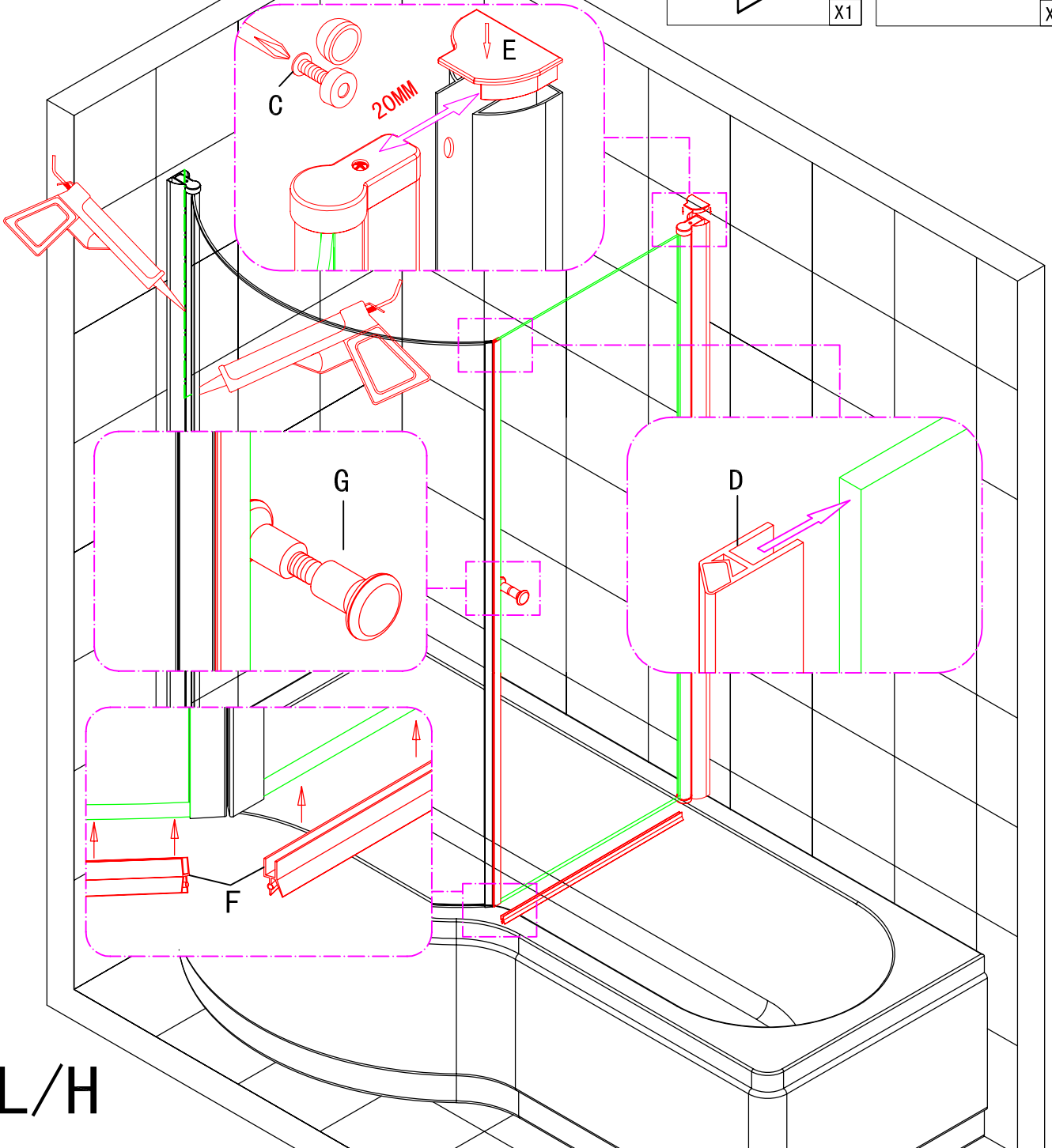
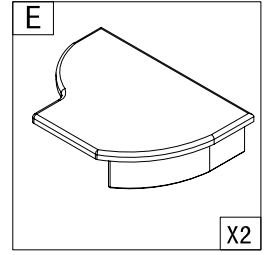
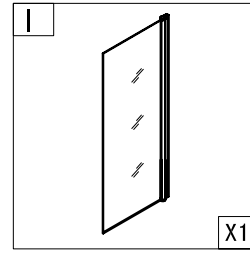
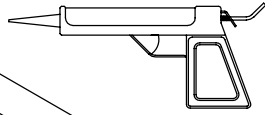
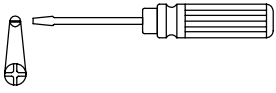

L/H

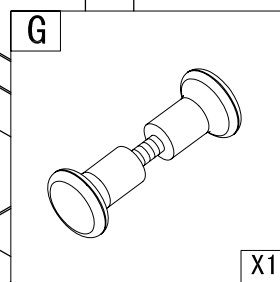
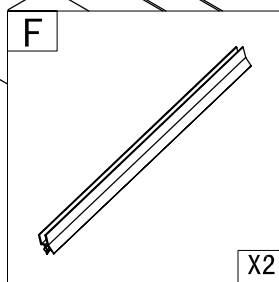
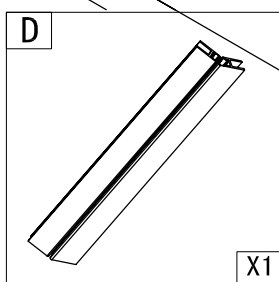
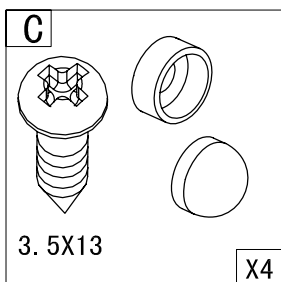

L/H

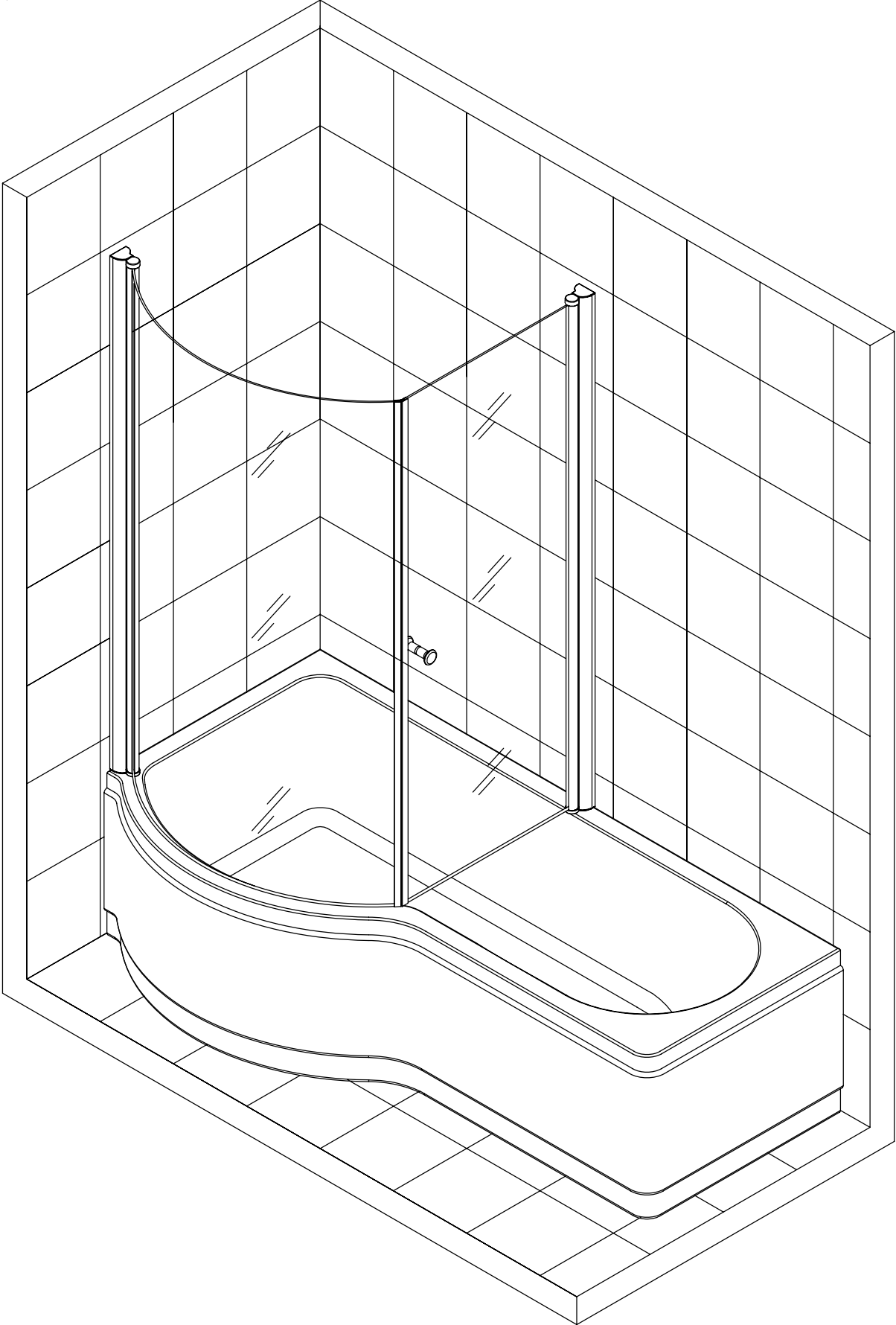

Cleaning & Maintenance

Inside shower door glass with "easy cleaning" liquid

Don't clean the shower enclosure with irritant detergent such as alcohol, bleach or other chemical cleaners.

Only clean with warm soapy water.

After the installation is completed, should you find that there is notable noise when the glass door moves, you may add a small quantity of lubricant onto the roller wheel, slipping hook and the track.

The logo for Eastbrook, featuring the word "Eastbrook" in a bold, white, sans-serif font centered within a blue, wavy-edged rectangular shape.

Eastbrook

Eastbrook Road, Gloucester GL4 3DB
Technical Helpline: 01452 317890
email: technical@eastbrookco.com