

Eastbrook

Eastbrook Road, Gloucester GL4 3DB

Technical Helpline: 01452 317890

email: technical@eastbrookco.com

The Document M – 2007 Guidance and Care Instructions

Pull Rail
Fixed to
Door

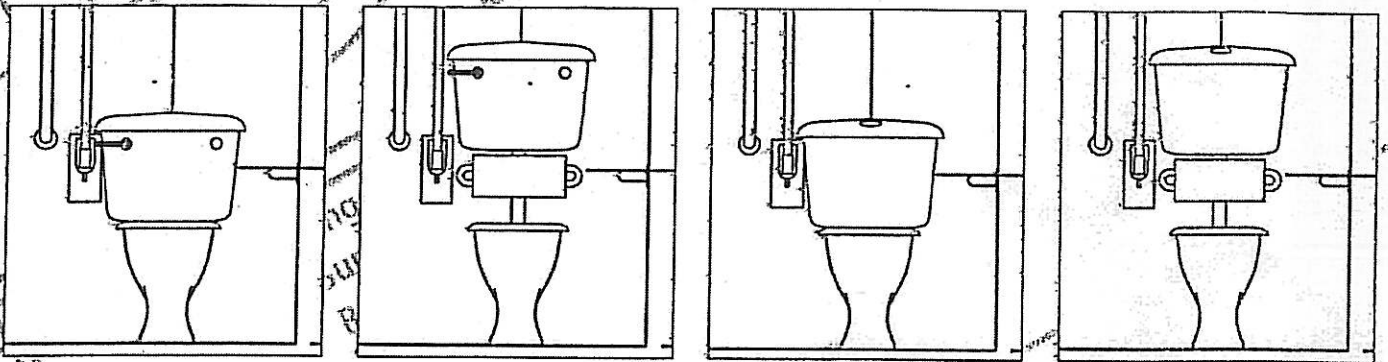

Min 2200
Plan of a typical installation

Please leave for inclusion in property maintenance file

Contents of pack:

- 1 off White close coupled pan - 455mm high
- 1 off White push button cistern (bottom inlet)
- 1 off Push button cistern pack
- 1 off White seat (filing only)
- 1 off White wall hung basin 450 x 320mm
- 1 pair basin hangers
- 1 off Chrome lever action spray mixer tap
- 1 off Chrome 32mm flush grated waste
- 1 off 32mm plastic bottle trap
- 5 off 600 x 35mm grab rails
- 1 off Hinged support rail including toilet roll holder

970

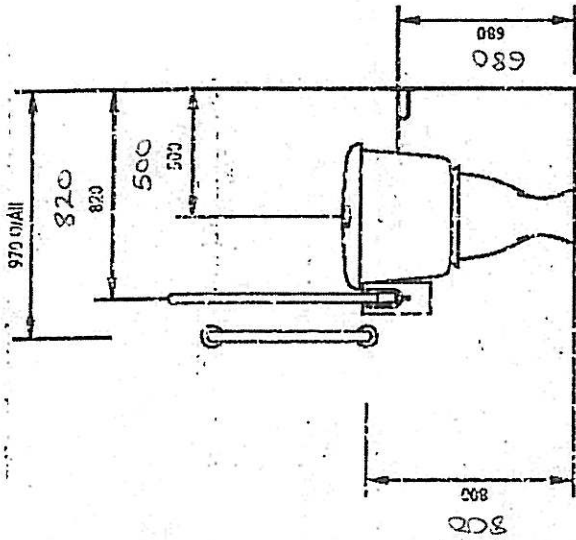

View on B-B

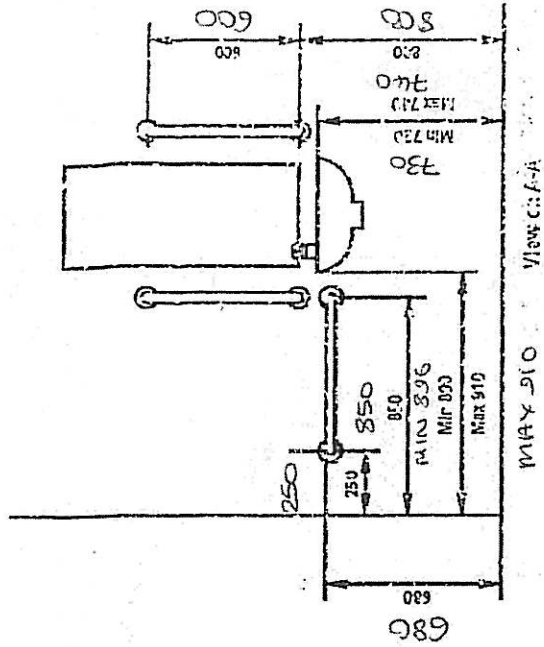

View C-A-A

MAY 210

Doc M Push Button C/C

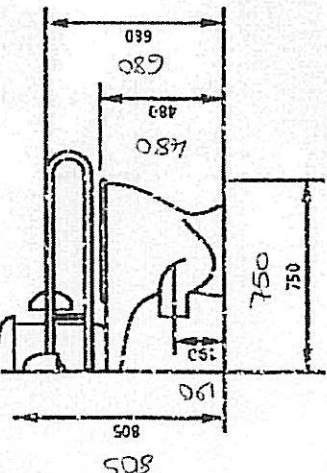
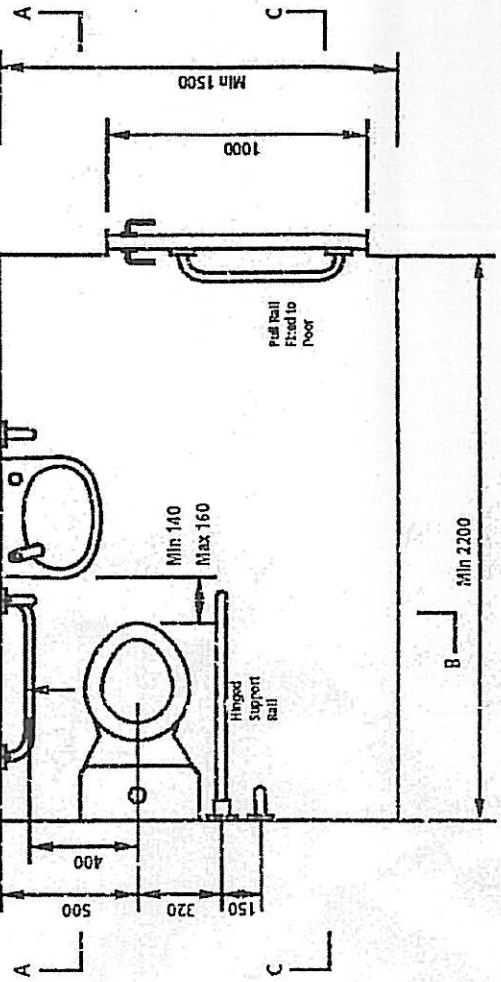
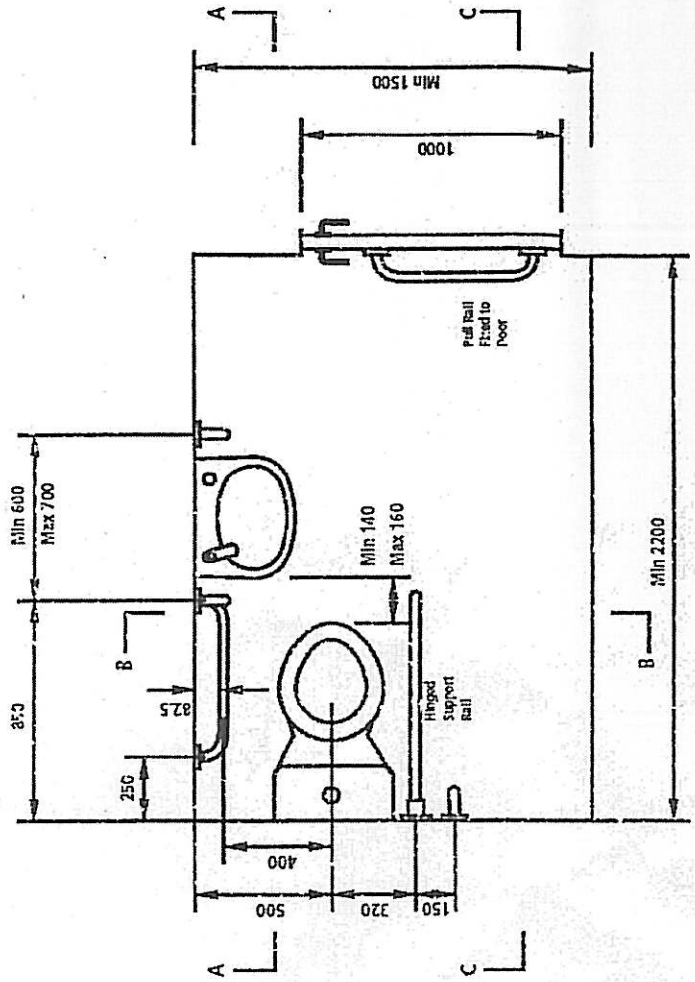

805

The Document M Toilet Packs – Guidance Notes

In November 2003 the revised Approved Document M of the Building Regulations was published. This covers all aspects of 'access to and use of buildings' giving details of suitable products, their design and layout within the building/ extension.

In Section 5 it details the requirements for 'Sanitary Accommodation in Buildings other than Dwellings', giving as its primary objective *the provision of sanitary accommodation for all irrespective of level of ability*. It goes on to detail the numbers and types of facility for different sizes and use of buildings, giving specific information on the type, quantity and layout of toilets to be provided. The provision of adequate space for independent use and/or assisted use is emphasised. Diagram 18 features a typical layout and note should be taken of the location of rails and fittings in relation to the space requirements needed when using a wheelchair.

Diagram 18 Unisex wheelchair-accessible toilet with corner WC

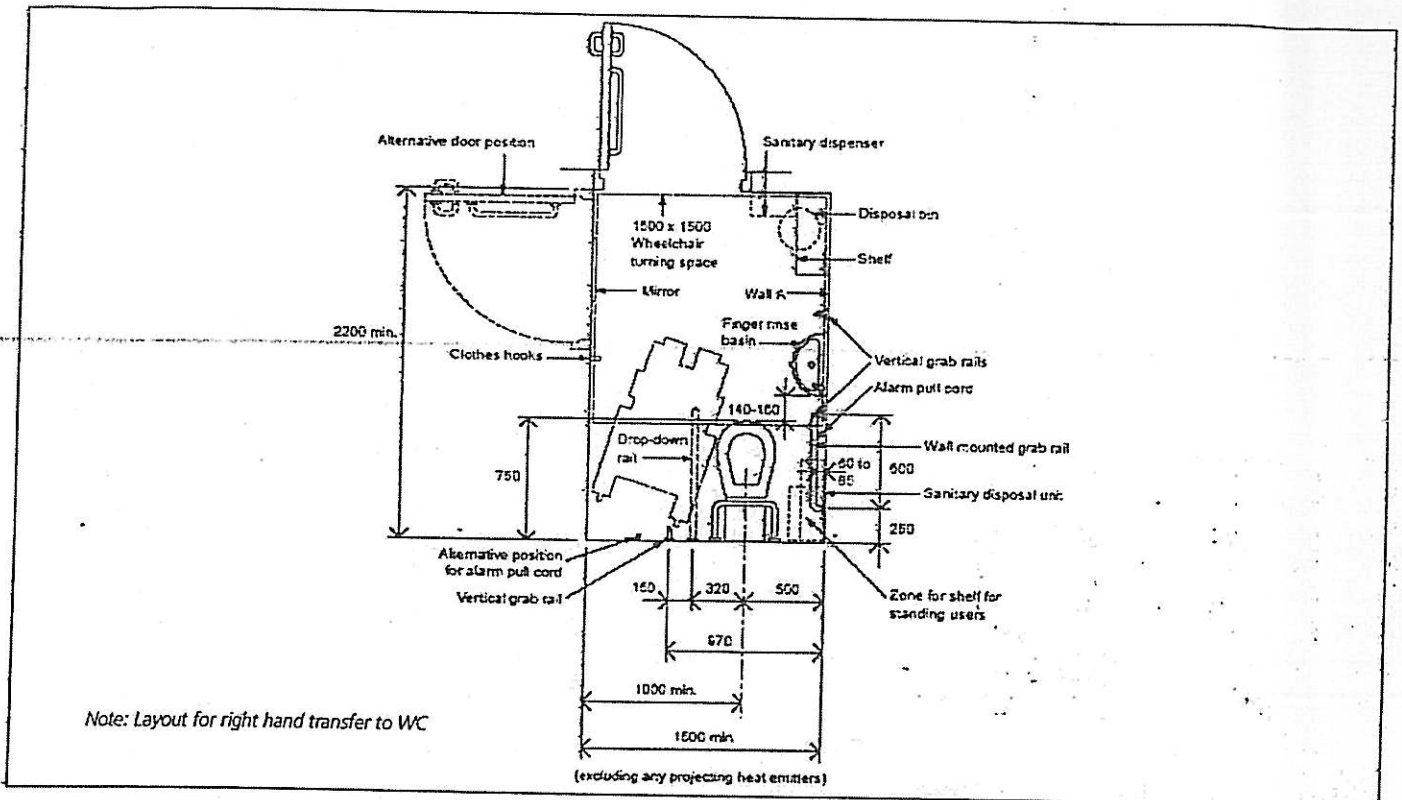

Also within the Approved document there are a number of guidelines which should be noted, such as:

- The surface finish of sanitary fittings and grab bars should contrast visually with the background wall and floor finishes and there should also be visual contrast between wall and floor finishes.
- The open space i.e. the side of the w.c. with the drop down rail, should be left clear for operation of the wheelchair, as illustrated.
- It should be possible for the user to use the washbasin whilst on the w.c. and a dimension is given between the end of the w.c. pan and the edge of the basin to ensure this.
- Basins cannot be located other than in the position indicated.
- Basin taps should be capable of being operated using a closed fist — i.e. Lever action.
- Grab rails are set at a consistent height of 680mm from the floor.
- Cisterns should be provided with an extended Spatula lever, which should be positioned on the open side, i.e. the hinged rail side, of the w.c.
- There should be no more than 400mm between the centre line of the w.c. and the centre line of the horizontal rail on the adjoining wall, otherwise an additional hinged rail has to be fitted.
- The height of the pan and seat is set at 480mm, to allow easy transfer from a wheelchair.
- The seat needs to be of robust design, fitted with stainless steel hinges and be capable of being securely located to prevent lateral movement during transfer from wheelchairs.
- Open front seats and seats with covers should not be used.
- There is a requirement to provide shelving, clothes hooks and alarm pulls.
- Position and height of other fittings/accessories, usually obtained separately from a Document M Toilet pack, are detailed on Diagrams 19 and 20.

Diagram 19 Heights and arrangement of fittings in a unisex wheelchair-accessible toilet (looking towards wall A Diagram 18)

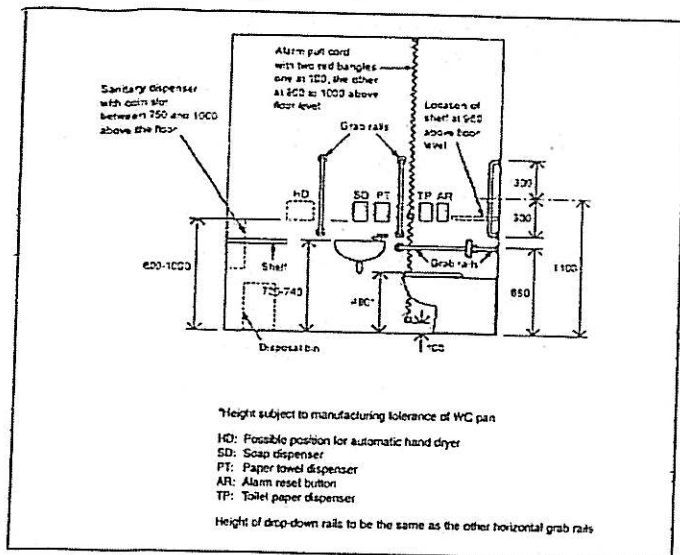
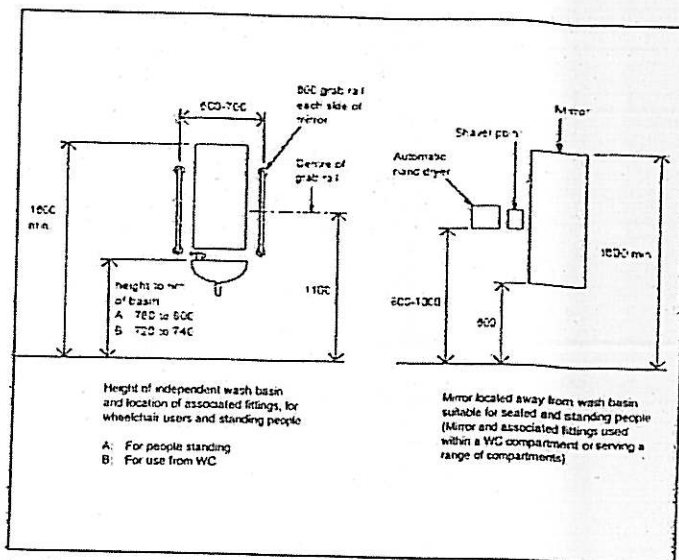

Diagram 20 Heights of various fittings in toilet accommodation



Copies of the Approved Document M detailing full requirements can be obtained from the Stationary Office - PO Box 29, Norwich NR3 1GN, or from Regional branches - details of which can be found on www.tso.co.uk/bookshop.

Care and Cleaning Instructions

Within the Document M Pack a number of different materials are used and caution should be exercised in the use of modern 'all purpose' cleansers, many of which include chemicals which over time will damage the surface finish, and consequently reduce the durability of the products fitted.

Sanitary Ware

Vitreous China conforms to BS3402: 1969 and is 99.5% vitreous. This means that even unglazed it is virtually impervious and will not absorb contaminants and will remain hygienic in use. It is also covered with non-crazing vitreous glaze to further ensure its hygienic qualities.

If cleaned regularly with mild detergent it should retain its original appearance without resorting to abrasive cleaners or strong bleaches. These should be avoided since prolonged exposure to liquid or solid bleach based cleaners is likely to break down the glazing and leave unsightly stains.

Rails and Hinged Arms

These are coated with baked polyester coating, which is a durable, water resistant surface. They are designed to withstand the rigours of regular use provided reasonable care and cleaning is exercised.

Care should be used to avoid the use of harsh, abrasive cleaners, or any tools or sharp instruments, which

could break down the water resistant surface finish. Regular cleaning with mild detergent is recommended to prevent any build up likely to call for use of extreme measures to restore the surface finish.

Toilet Seats

The seat is manufactured from plastic material, which is very strong and durable. It is fitted with self colour hinges.

It is a heavy-duty seat designed to give lasting performance, but, by virtue of its use, requires regular cleaning to maintain both its looks and hygienic qualities.

Cleaning should be carried out regularly using warm water, with mild washing up liquid.

Spray Mixer Taps

The Spray Mixer tap is manufactured in Chrome plated Brass to give a very attractive and durable fitting. The Chrome surface finish requires the minimum of cleaning, and if carried out regularly will give lasting service.

The quarter turn ceramic cartridge is adjustable to allow the mixer to be set and is designed so that any build up in the cartridge is removed by regular use.

Back Rest Pad (if fitted)

This is a soft plastic covered upholstered pad with minimal resistance to damage.

Gentle cleaners, such as washing up liquid, should be used regularly and under no circumstances should sharp instruments be used which might puncture the pad covering material.

BUILDING CONTROL

CERTIFICATE

NATIONAL
TYPE

APPROVAL

Certificate No: 404-12-7161

Date: 14 May 2007

1 Certificate holder

Name:

Address:

Tel:

2 System Title

Description: DOC M PACKS, DMCCL - DMCCP - DMLLP - DMLLL

3

The system has been assessed on the following drawings and documents:

Doc M Push Button L/L

Doc M Lever Flush C/C

Doc M Push Button C/C

~~Doc M Lever Flush L/L~~

4

4 Assessment

The design and method of construction of the system described in (2) above has been examined and as far as it has been shown has been found to be capable of complying with current Building Regulations.

5

5 Conditions of certification

- 1 The design shown and the materials specified shall not be changed without reference to the local authority responsible for certifying the system.
- 2 The certificate shall be valid for three years or until invalidated by formal notice.
- 3 Where reference is made on a plan to any Code of Practice, British Standard or manufacturer's instruction it shall be construed as a reference to such publication in the form in which it is in force at the date of certificate.
- 4 This certificate should not be regarded as a formal approval under the Building Regulations.

6

6 Authority

This system approval certificate is authorised by:

Name: David Harrison

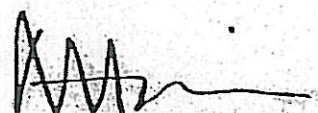
Signature: 

DOC W LOW LEVEL

Contents of pack:

- 1 off White low level pan - 455mm high
 - 1 off White universal cistern with left or right handing (bottom inlet)
 - 1 off Custom pack and white PVC flush pipe
 - 1 off Chrome spatula flushing lever handle
 - 1 off White seat (ring only)
 - 1 off White wall hung basin 450 x 320mm
 - 1 pair Basin hangers
 - 1 off Chrome lever action spray mixer tap
 - 1 off Chrome 32mm flush grated waste
 - 1 off 32mm plastic bottle trap
 - 5 off 600 x 35mm grab rails
 - 1 off Hinged support rail including toilet roll holder
 - 1 off Padded back rest support
- Claygate Stock Code: 52 DMLL*

