

Code No.: 33.0021
Dimensions: 1560x720x760mm

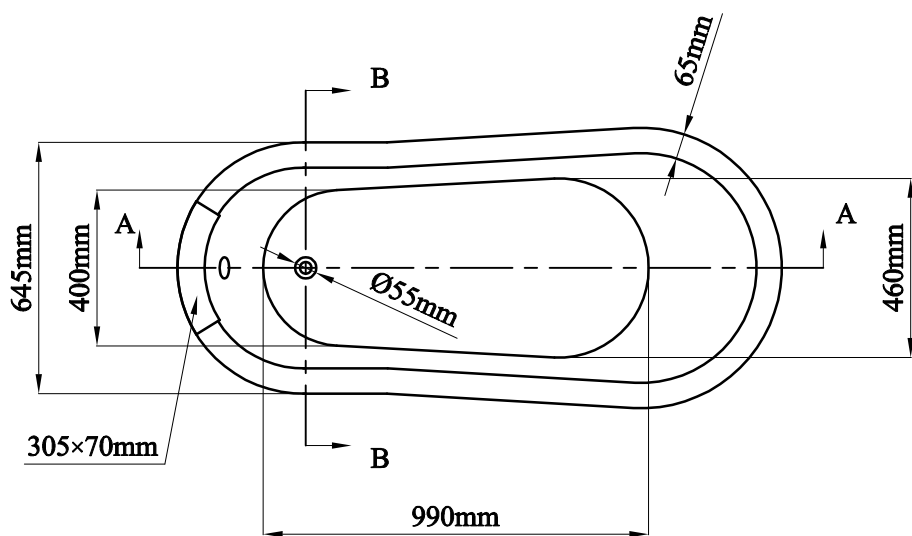

SECTION A-A

SECTION B-B

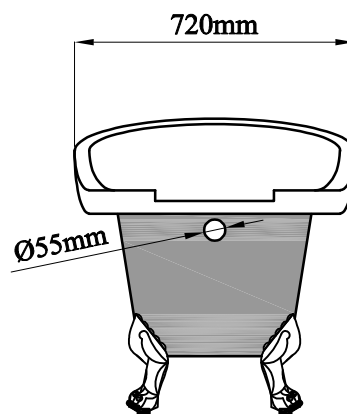
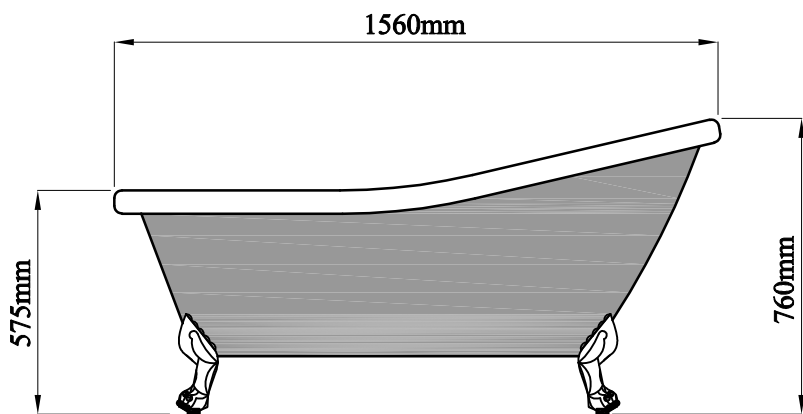