

DATASHEET

Image



General Information

Product:	41.0108
Description:	Wendover Curved Multirail 600 x 600
Website Link:	(Click Here)
Product Type:	Towel Rail
Brand:	Eastbrook Company
Colour:	Chrome
Material:	Mild Steel
Height (mm):	600mm
Width (mm):	600mm
Net Weight (kg):	5.1kg
Product Range:	Wendover

Product Specifications

Warranty:	5 Year(s)
Supplied with fixings:	Yes
BTU $\Delta T50^{\circ}\text{C}$:	693
BTU $\Delta T60^{\circ}\text{C}$:	887
Watts $\Delta T50^{\circ}\text{C}$:	204
Watts $\Delta T60^{\circ}\text{C}$:	260

Drawing

Wendover Curved 600 x 600mm. Technical Drawing

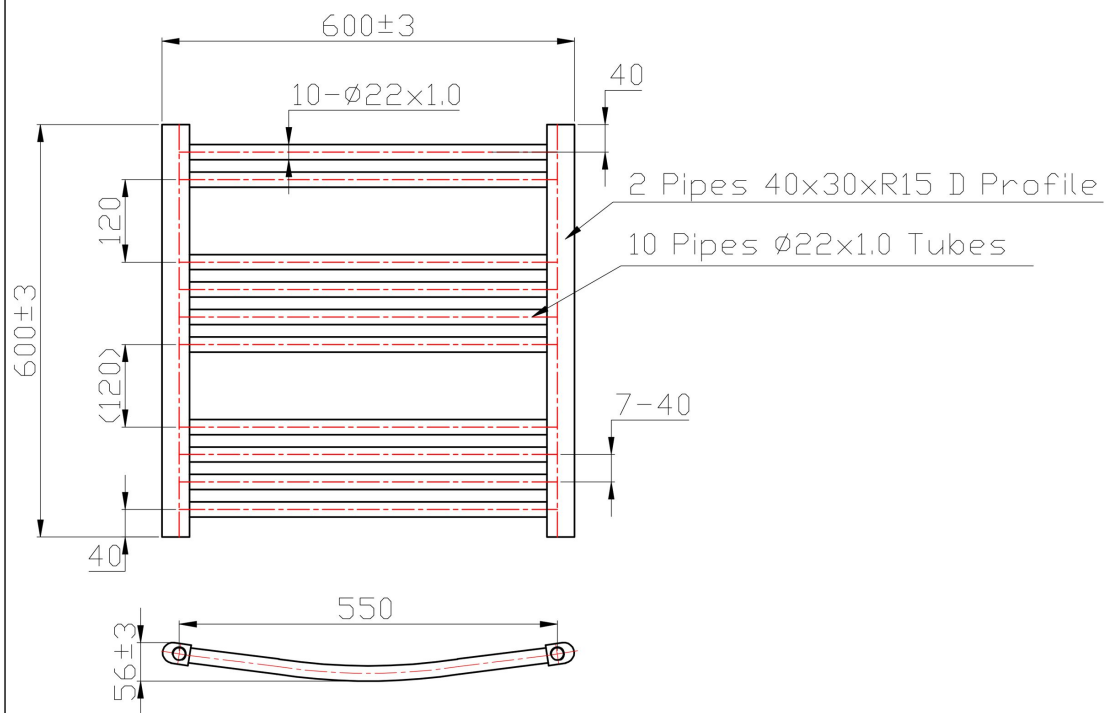

Eastbrook 
Eastbrook Road, Gloucester GL4 3DB
Technical Helpline : 01452 317890
Mon - Fri / 8am - 5pm
Email : technical@eastbrookco.com